

BOOX NoteAir2

Mighty E-ink Tablet

User Manual

Contents

1. Standard Accessories.....	3
2. Safety Guide.....	4
3. Product Views.....	6
4. Main Interface.....	9
5. Library.....	27
6. Reader.....	39
7. Store.....	87
8. Notes.....	90
9. Storage.....	118
10. Apps.....	122
11. Settings.....	158
12. Specifications.....	180
13. Declaration.....	181

1. Standard Accessories

(1) BOOX NoteAir2	x1
(2) Stylus Pen	x1
(3) Type-C Cable	x1
(4) Quick Start Guide	x1
(5) Warranty Sheet	x1

Optional Accessories (purchased separately)

- (1) Adapter
- (2) Protective case

(Note: The E-books in the following illustration are not pre-stored)

2. Safety Guide

Please read the Safety Guide carefully before you start to use the device.

Contact your BOOX retailer if you have any technical problems, or you can dial our official service line at 4008-400-014 or 4008-860-830.



Screen protection

The device is equipped with an E-ink screen, which is very fragile. Please have no shocking, squeezing, pressing against the screen, or dropping the device from a higher place. If the screen is already broken, stop using it and contact a professional or other qualified staff to replace the screen for you. Please don't dismantle the device without our permission.



Standard accessories

Only the battery, adapter, and other accessories meeting our standard safety rules can be used for the device. For details, please refer to Product Specification. We will not be responsible for any damage caused by incompatible accessories.



Stay away from liquids

The device is not waterproof. Don't expose the device to a humid environment or use it in the rain. Please keep it away from any corrosive liquids.



Don't dismantle the device

Please don't dismantle the device in case of any damage.

Inappropriate battery model may cause explosion. Please contact official after-sale team for battery replacement if needed. Users shall undertake the responsibility and deal with the obsolete battery if users replace batteries themselves.



Using environment

The using environment of the device is 0° C-50° C.

3. Product Views

Front View

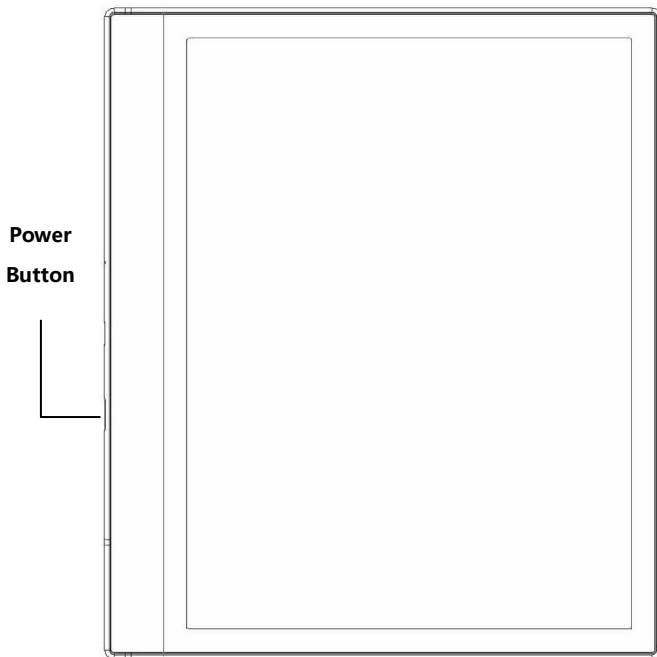

Left-side View

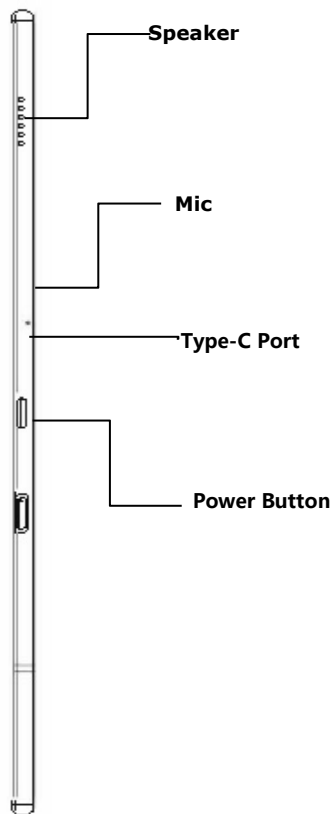

Button Function

Power/ sleep Button	<ul style="list-style-type: none">● Press the power button to turn on the device● Long-press the power button for 2 secs, then select “Power off” in the menu to turn off the device● Press the power button and release quickly to let the device goes into sleep mode● Press it again to wake up● Long-press for 10 secs to force shutdown
Microphone	<ul style="list-style-type: none">● Record voice● Recognize speech
Type-C Port	<ul style="list-style-type: none">● Connect the device with PC to transfer data or charge device.● Support Type-C earphone● Support OTG USB drive

4. Main Interface

The main interface contains a system bar, content area, and function area.

The function area contains certain modules.

Double-click icons in function area can return to the main page of the specific module.

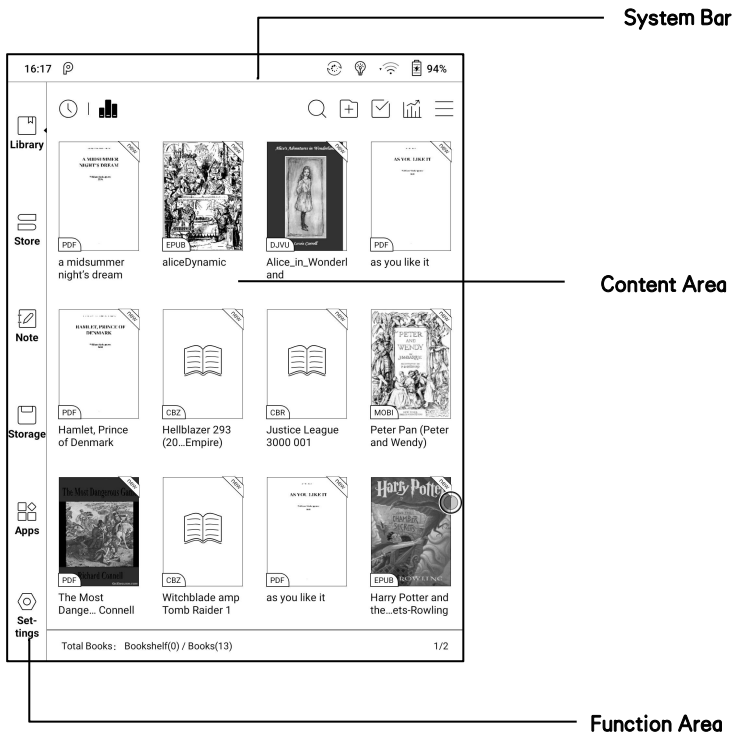

System Bar

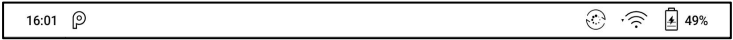

This section displays the current state of the device, including: Time, Notification, Refresh Mode, Wi-Fi Connection, Battery Usage. It is only for status indication.

Split Mode (default):

Pull down " Notification Center" from the left side and pull-down Control Panel from the right side.

Classic Mode:

Pull down both Notification Center and Control Panel in the same time.

Notification Panel

This center contains information such as USB connection notification, third-party push notification. Tap the notification to jump to the corresponding app.

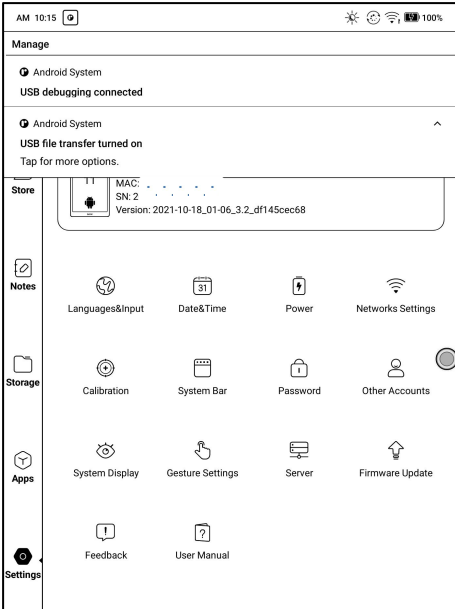

Control Panel

This panel contains Date and Time, Wi-Fi, Bluetooth, E Ink Center (swipe up from the screen bottom to call out), Brightness adjustment, Volume adjustment. The above-mentioned items are permanent and cannot be removed or edited.

Screen orientation, Hand Touch On/Off, Screencast, Screen Record, Split Screen, BooxDrop, and Feedback are optional items. You can edit them.

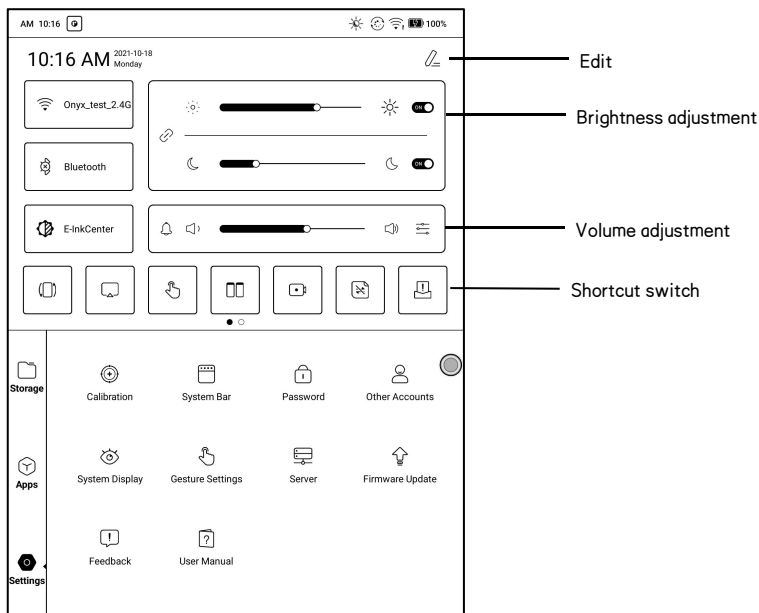

E Ink Center

Open it from Control Panel or swipe up from the bottom to open it. This section includes Dark Color Enhancement, Light Color Filter, Refresh Modes (System), Shortcuts...etc.

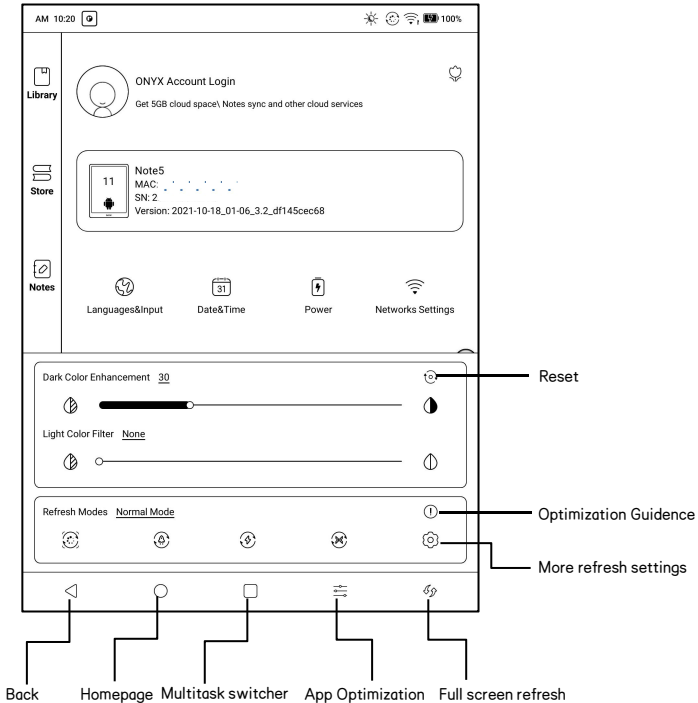

Refresh Modes

The system-level Refresh Mode takes precedence over the application Refresh Mode. That is: when the system is set to the Normal Mode, the application uses its own refresh settings; When the system is set to the other modes, the applications will use the system's refresh mode.

There are 4 Refresh Modes:

Normal Mode (Default): Good display effect, suitable for ordinary text reading.

Speed Mode: Slight ghosting and aliasing effect, suitable for thumbing through eBooks with text and images.

A2 Mode: Slightly heavier ghosting and aliasing effect, suitable for browsing images and text by quick sliding.

X Mode: Heaviest ghosting and aliasing effect accompanying detail loss, suitable for browsing websites and video playback.

Use A2 Mode by default for scrolling

After you change the Refresh Mode, you can change contrast for a better

display effect.

The color model does not support X Mode.

Dark Color Enhancement

You can deepen the darker color of the page to black, which is generally used to enhance the foreground color, or the light-color page that needs to be darkened such as color icons, PDFs with poor scanning quality, etc.;

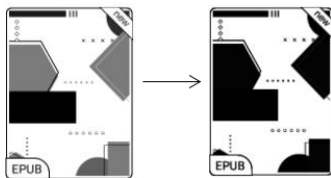

Light Color Filter

This can dilute the lighter-color page to white. It is generally used to bleach the background color;

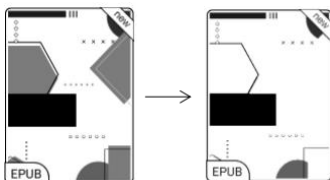

Wi-Fi Setting

When using at the first time, you should enter into the Wi-Fi setting interface to get a accessible connection. Then click the icon to turn on/off the auto connection.

Bluetooth Setting

When using for the first time, you should enter into the Bluetooth setting interface to match a device you want. The matched earphone, page turner can be auto-connected by clicking the icon. Certain devices do not support auto connection after disconnected.

Rotation

Easily change the orientation of the screen by clicking the direction you want.

Function Area

The function area includes Library, Store, Note, Storage, Apps, and Settings.

The default Homepage is Library. Double-tap the Navigation Ball to return to the Homepage

Users can go to Settings / More Settings to set any of the other function pages as a default Homepage.

Content Area

The contents are sorted by time by default. The contents includes the following items.

Library

All books in supported format from internal storage are displayed here.

The scanning path can be modified via Library Settings.

Store

Enter into an online eBook store. Users can view more book information and make a purchase. Purchased books will be added to the list of Library.

Note

Users can create a new note here, create folders for sort management, and export note files to third-party apps.

Storage

All folders from internal storage will be displayed here. Users can manage documents and folders from the page.

Apps

All third-party apps are displayed here. Users are allowed to manage or optimize the apps.

Settings

The list of system settings help to manage the device.

ScreenCast

1. This only supports Windows10. Win7/XP and MacOS are not supported currently.
2. Please make sure that the computer itself supports the screencast function, which can be checked in the computer system settings: System-Projecting to this PC.

Please pay attention to the 4 related settings, which will affect the results of searching the computer on the device side and the confirmation of the connection request;

This computer can support the state of screen projection

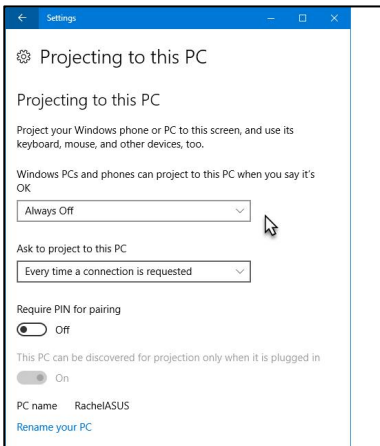

This computer does not support screen projection

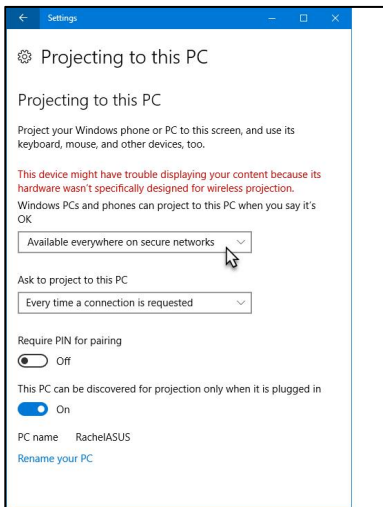

3. Please make sure that the computer and your BOOX are in the same Wi-Fi environment.

If a desktop computer is connected to Wi-Fi via wireless network card, please confirm whether it is supported in step 2.

Some computer configurations and wireless network cards do not support this function;

4. On the device side, select screencast from the system drop-down list. Then the automatic search will start, and the name of the computer will be shown when found.

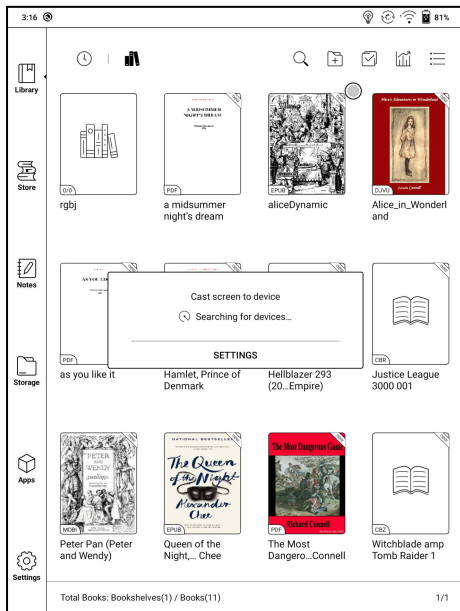

5. In the search window, select the found computer. If there are multiple supported computers, click Settings to enter the list of supported computers. Then select the computer that you want to project to from the list.

6. After you select the computer that you want to project to, the computer will pop up a notice to confirm whether to accept the projecting request;

7. After you confirm it, it will automatically connect and the screen will be mirrored successfully;

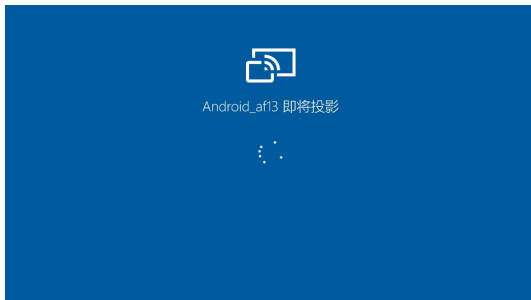

If the "Unable to view protected content on this device" appears on the screen, the connection may be unsuccessful. Please disconnect the device, and request the screencast connection again.



8. When the devices are connected, please tap the system bar of the device– Screencast again, and select “disconnect”. The computer cannot disconnect the connection.

If the computer supports screencast but cannot receive the request, please restart the computer and try to reconnect again and check whether the computer configuration rejects the request (see step 2).

Screen Record

Long press Recording button on the screen to enter the Screen Recording settings. You can customize Resolution, Image Quality, Screen Orientation, Sound Source, etc.;

When you use Screen Recording for the first time, you are recommended to adjust the relevant settings first.

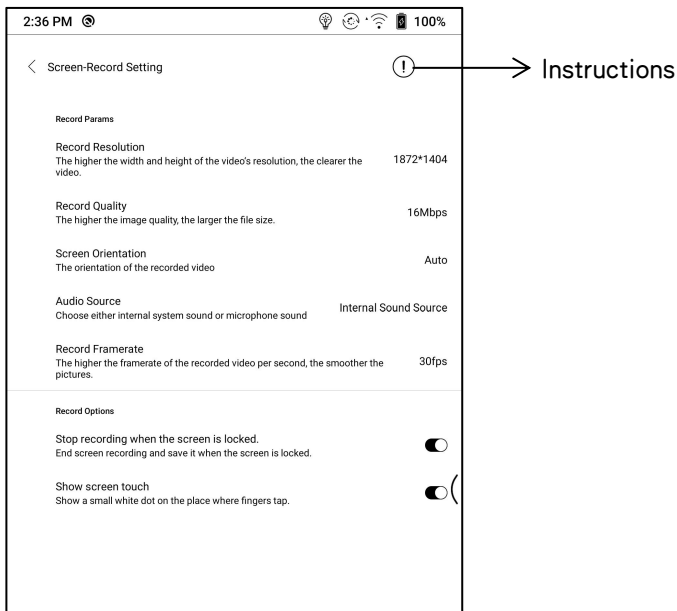

Tap the Screen Record icon to open the floating window of screen recording. Tap the “Start” icon to start recording and tap the Close icon to stop recording;

After you stop recording, there will a thumbnail displayed in the upper right corner, and you can tap it to play or share; Long press the floating window to drag it around on the screen. The floating window will not be recorded into the video;

After the Screen Record is enabled, the floating window will always stay on the upper layer of the screen. You can create new screen recordings continuously. If you need to close it, you can manually tap X to close it.

The Recordings’ format is MP4 and the save path is:

Storage/Movies/Captures

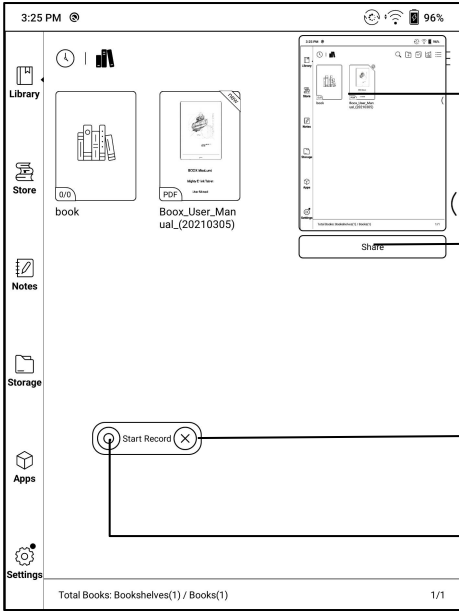

→ Preview

→ Share

→ Close

→ Start / Pause

5. Library

The library only displays E-book documents in supported formats in the storage. Book cover thumbnail is displayed by default. E-books are sorted by the creation time.

On the upper right working area of the Library, users can search, create a new bookshelf, manage books in bulk, check Reading Statistics, pop up the drop-down menu (including Filter, Refresh Library, Scan Covers, Library Setting, Switch to List View)...etc.

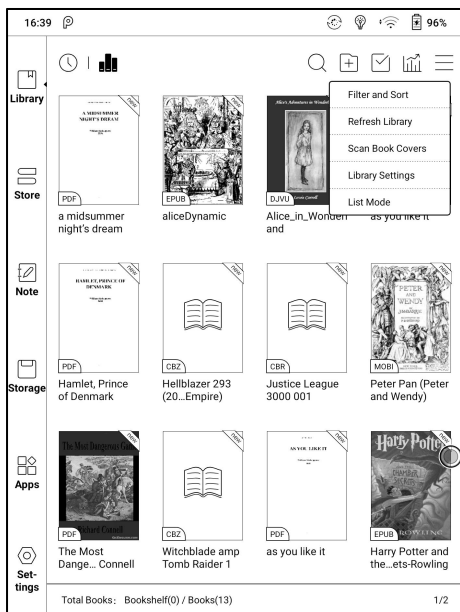

Library Display Switch

Click on these icons to switch the library display. By default, it auto-scans and loads all the supported documents in specified paths, sorted by a specified way.

Another one is to display the content based on the structure of storage.

The icons change after clicking on it.

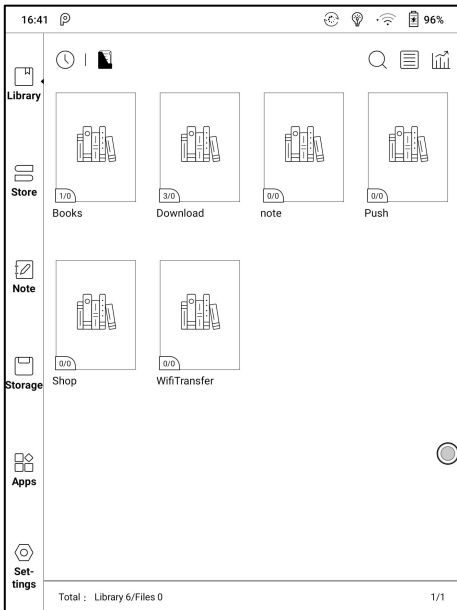

Filter & Sort

By default, it shows all books in descending order.

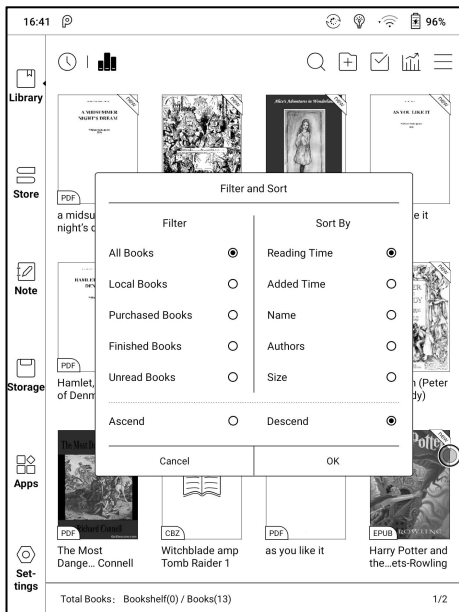

Refresh Library

“Refresh Library” gets all documents in supported formats scanned and rebuild library list. This function does not delete the reading history.

Create Sub-library

It helps to manage books by file manager.

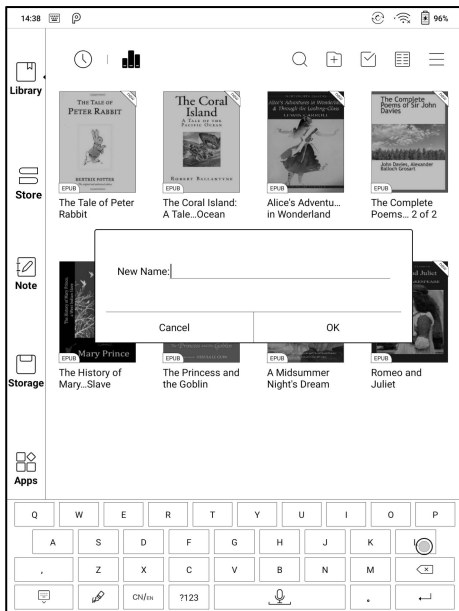

Library Settings

It supports custom scan path. You can set certain storing path as Automatic Scan;

After the scan path is set, the Library will be reloaded. The books that are not in the scan path will be removed. If you need to read the books, you can find the original file in the storage;

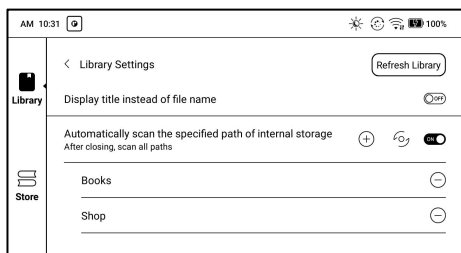

Sub-library Attribute

Long-press on sub-library cover to view more information about sub-library. To delete or rename sub-library are allowed. When deleting sub-library, the containing books will be moved to Library and will not be deleted with the sub-library.

E-book Attribute

Long-press on book cover to view more information about E-book name, author, format, size, reading progress, book detail(only available for the E-books of Store), open way, Lock、rename, move(to sub-library) and delete. One E-book only can be added to one Sub-library.

As for the books purchased from the Store, is allowed to view book details by jumping to the Store page.

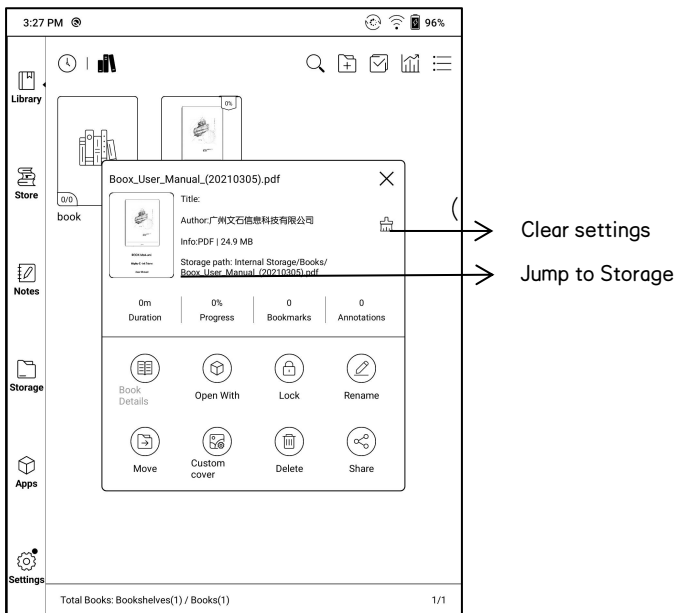

Clear settings including : clear password default settings , clear reading data , Clear Cache、Clear book Cover;

BOOX_Nova3
Color Use...

Clear password default settings	<input checked="" type="radio"/>
Clear reading data	<input type="radio"/>
Clear cache	<input type="radio"/>
Clear book cover	<input type="radio"/>
Cancel	OK

Lock (Reading Password)

User can add (reading) Password to lock each file in order to protect personal reading data;

The Password is used to open the file, but it only applies to the same device and NeoReader. If you copy and export the file to other devices or Apps, the Password will become invalid.

You can use the same Password as the Screen Lock. Or you can set a different digits Password.

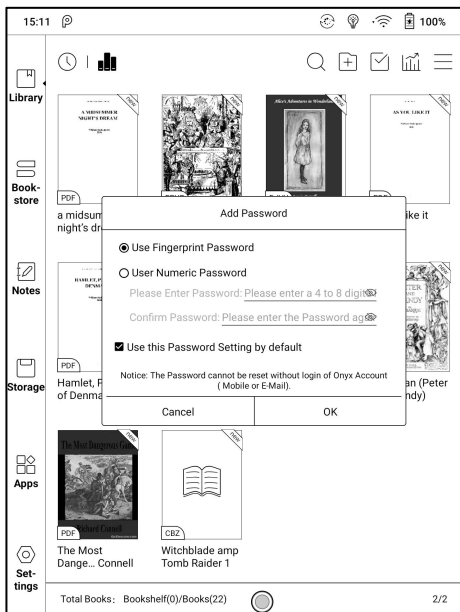

Digits Password only support one Password. After you have set the digits Password, you do not need to set another digits Password and only need to add the Lock.

Reading Password supports individual setting or setting in bulk (setting in bulk is to add Locks). Currently It does not support to add Passwords to all files directly.

If you choose to use this Password Setting by default, you can add Password to other files quickly and do not need to re-select the Add Lock Option every time after the Password is set for the first time.

Reading Statistics

This page includes the Reading Time of Today, The Books that Have Been read, The Books that Have Been Finished, Total Time, Highlights and Annotations, and Recently Finished Books;

The average reading time this week is based on 7 days and calculates the average daily reading time during the week;

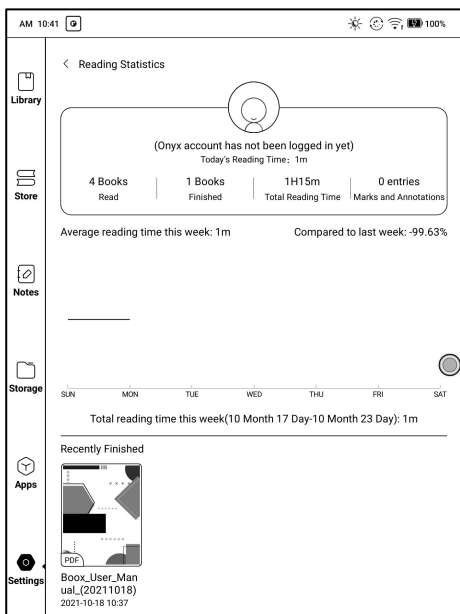

Average Reading Time Distribution includes the reading time of all days since Reading Statistics is turned on.

Under Reading Statistics, only highlights and annotations can be jumped to and the books that recently have been finished can be opened. Other data is only for analysis purpose.

The reading data of each device can only be available on the same device.

You cannot check the statistics of this device on another device.

Share (Third-party App)

This supports sharing files through third-party App. The sharing path is automatically obtained according to the installed Apps.

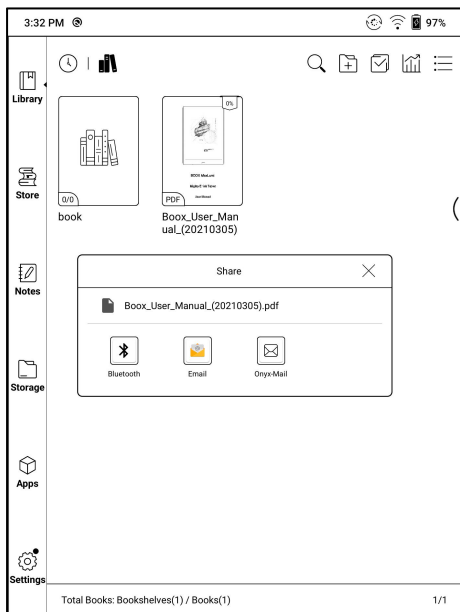

6. Reader

Tap any E-book cover to open an E-book. Full-screen reading without showing status bar is set by default.

To pull down from the top of the screen can call out the status bar.

To tap on the center of the screen can call out the menu bar for switch among different documents or other functions

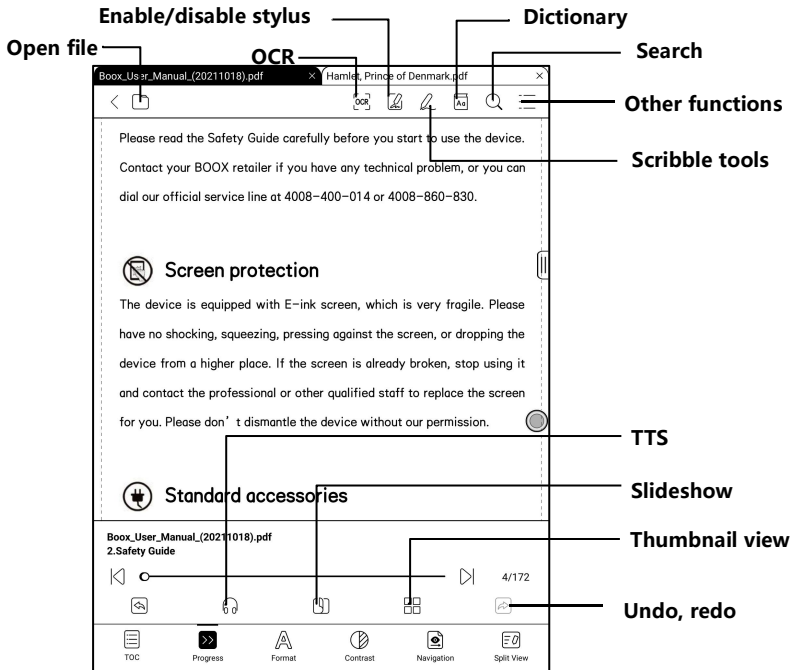

Floating Toolbar

You can choose to activate the Floating Toolbar for the first time when you open a file. Or you can go to Settings / Floating Toolbar Settings to enable it and customize the function buttons in the Floating Toolbar.

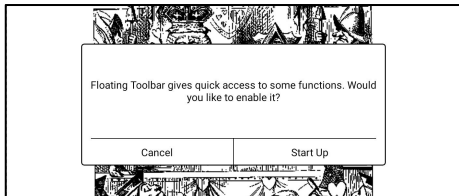

The Floating Toolbar includes: Hide, Scribble, Enable Palm Rejection, Menu, Prev Page, Next Page, Cancel (Progress)

Long press on the Floating Toolbar, you can drag it around on the screen.

You can expand or contract the Toolbar to the edge to avoid cover any text on the screen. When you need it, just swipe from either side of edge to the other side to expand it.

When the page is zoomed in, the Floating Toolbar would automatically expand proportionally in order to manage the zoomed-in page better.

Under zooming status, single tap on the screen is set for turning sub-pages of each page(each original page will require several time page-turns to be completed). But tapping the virtue page-turn buttons on the Floating Toolbar is set for turning the whole original page.

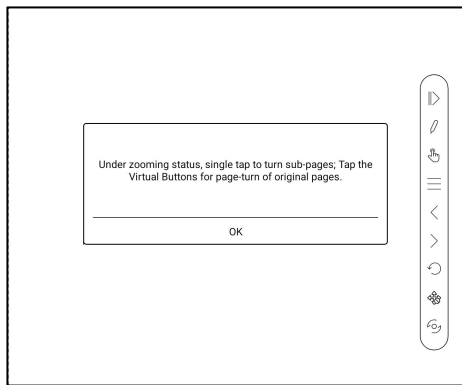

You can disable the Floating Toolbar by going to Setting – General Setting.

When it is contracted to the edge, you can swipe from either side of edge to the center of the screen to expand it.

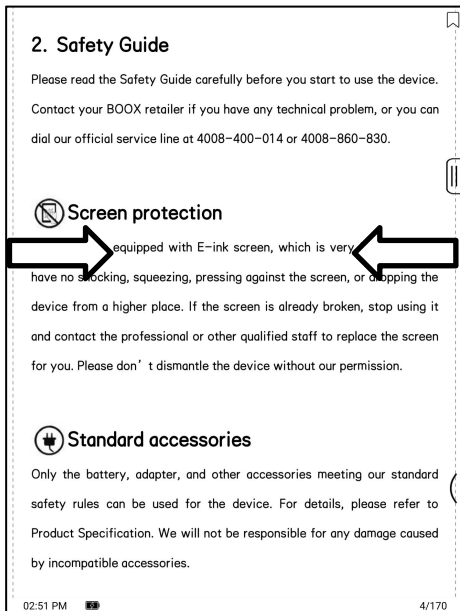

When palm rejection is enabled from the Floating Toolbar, it only applies to the reading document. The Floating Toolbar still supports hand touch, but it can remove the interference of hand when you write on the reading document.

Word Menu

Long-press on the word to pop up dictionary dialog for look-ups.

English word recognition and look-ups are supported.

Through the drop-down list on the top right of the dialog, the dictionary can be switched to others.

Users can download and install the dictionary themselves. Put dictionary file on the path root directory\dicts\xxx (e.g

Storage\dicts\English-French), or download dictionary online directly.

Dictionary is available to use after being installed.

Tap on any position out of the dialog to exit the dialog.

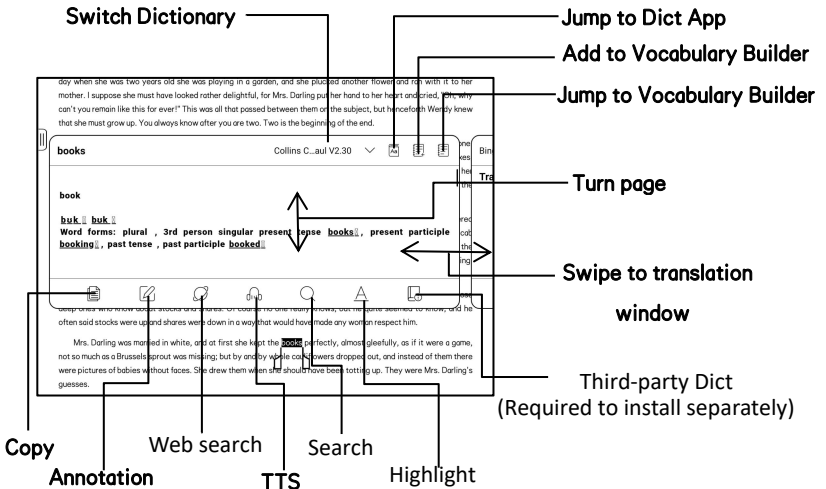

Long press on any word and drag to select the text you want to mark.

The highlight is set by default for selected text. Users can switch among highlight, underline, and others, the color highlight can be in black or grey.

The mark setting remains after a change. The marks before the change will not be affected.

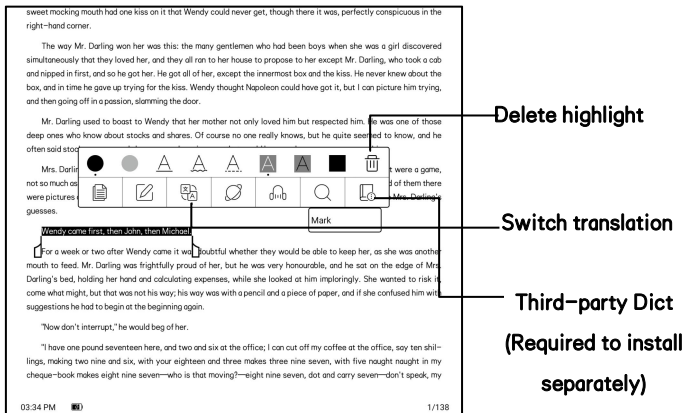

Tap on any position out of the dialog to exit the dialog.

Choose “Annotation” to pop out a text box to add notes if needed.

OCR (Beta Version)

Only supports pages in image formats PDF, CBR, CBZ, DJVU, and PNG.

Recognize one page only each time.

Choosing horizontal or vertical according to the document layout can improve the recognition accuracy.

Recognize 5 times a day when you are not logged in to your ONYX account.

Recognize 10 times a day when you are logged in to your ONYX account.

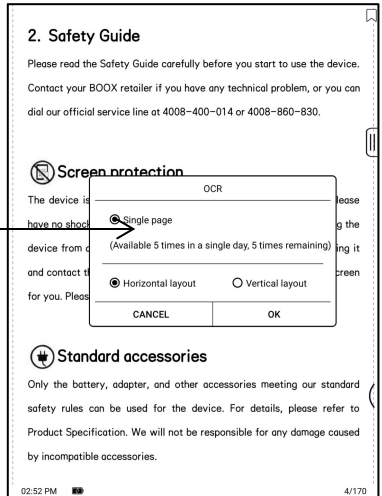
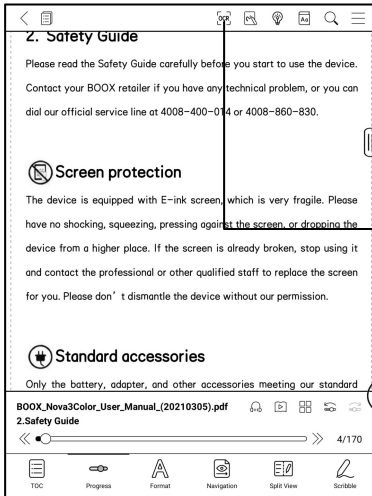

You can long-press text to add annotation and lookup dictionary on the recognized pages

If some individual characters are not recognized correctly, you can switch to the original text in the annotation pop-up window to correct them, and manually modify the recognized text content (Do not change the original page text);

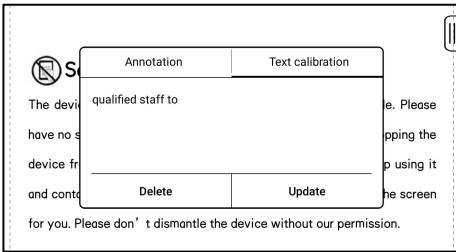

Pages recognized by OCR show the recognition mark in the upper right corner, and the recognized pages can be viewed in the Directory-Bookmark, which is convenient for quick locating and jumping; Tapping the recognition icon again will clear the OCR content;

Scribble Toolbar

The Scribble Toolbar is floating on the screen. You can long press it and drag it around.

The stylus is in handwriting state by default, and you can switch it On\Off in the top Toolbar;

The Scribble Toolbar needs to be called through the reading menu on the bottom or called from the collapsible Floating Toolbar.

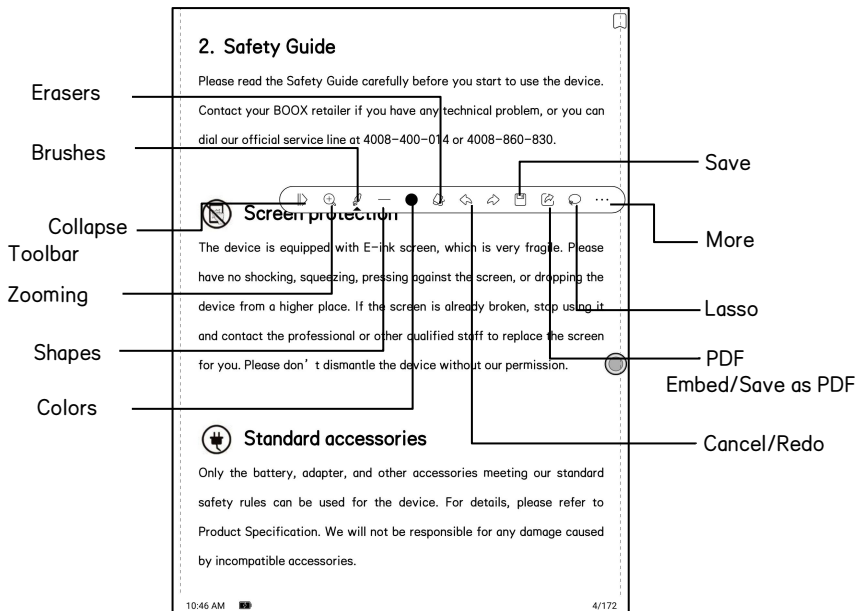

Brushes and Erasers

When in erasing state, you need to manually switch back to handwriting state to continue writing.

Colors

Only black, gray, and white colors can show their original colors on BOOX. Other colors are shown in black on BOOX and will be shown in their original colors when exported to PC.

Embed PDF

The handwritten contents on the PDF will be automatically embedded into the original file when you exit the PDF file. You can view and edit them with other apps such as Adobe Acrobat, WPS, and Chrome on PC. When copying the embedded files to other BOOX, you still can view and edit the files.

Embed PDF:

You can manually save the files in the Scribble Toolbar when the files are still open.

Save as PDF :

allows you to export in a new PDF file and keep the files with same handwritten content.

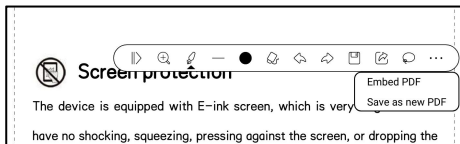

Non-PDF files do not support data embedment. You can only check relevant data on BOOX devices. When the files are copied or moved to other locations, they are identified as different files without relevant data. But changing file names do not impact the existing data.

PDF files with embedded data

- A. Changing file names, copying or moving to a different location will not impact the recognition of the embedded data.
- B. When the PDF files with embedded data are divided into multiple PDF files using other tools on PC, the new files will be identified as different files and will not import the embedded data
- C. When the PDF files with embedded data are edited and saved using other tools on PC, the files will identified as different files and will not import the embedded data.
- D. When multiple PDF files are merged into one file using other tools on PC , the new files will be identified as different files and will not import embedded data.

Note: If your BOOX is in handwriting state when it is connected to PC via USB, please disconnect USB connection to make sure data update normal. You can connect BOOX to a PC again via USB when PDF files are saved.

PDF files without embedded data

When a new PDF document is opened, it will automatically detect and import the local existing data according to the document ID and storage path;

For example: after you delete 123.pdf with embedded data from the local, and put the original 123.pdf file (without data) back, there are the following situations:

- A. If you put the file back to the same saving path, the existing embedded data will be automatically imported.
- B. If you put it back to a different saving path, the existing embedded data will not be imported.
- C. If you change the file name and put it back to the same saving path, the existing embedded data will not be imported.
- D. If you put other file with the name 123.pdf to the same saving path, the existing embedded data will not be imported.

Handwriting recognition

Double-tap the handwritten text or shapes to start AI Recognition.

In the state where hand touch is disabled, double-tap can also be used to initiate the AI Recognition

The text and shapes with 0.5cm spacing and straight lines with 0.3cm spacing can be recognized as one content area. If the spacing exceeds either of the two spacings, the content will be recognized as a different content area.

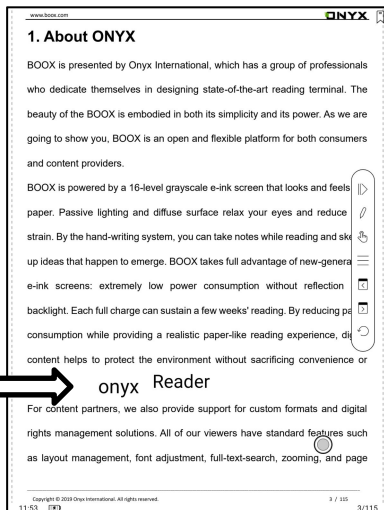
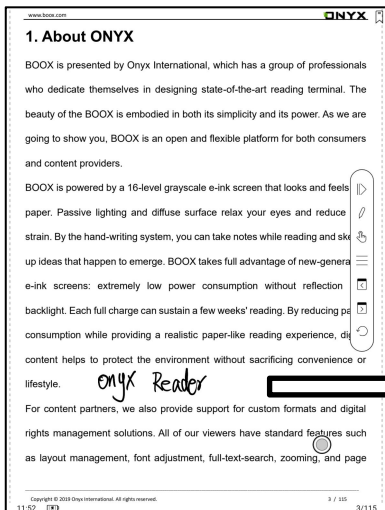

The boxes or lines near the text can be converted into underline and highlight after being double-tapped. That offers great convenience to add highlights to the converted content.

If users do not want it to be converted into highlights, you can disable this function from Handwriting recognition settings. The handwriting content will be only converted into images.

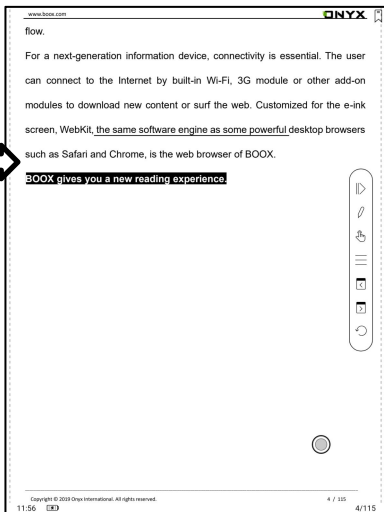
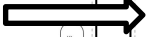
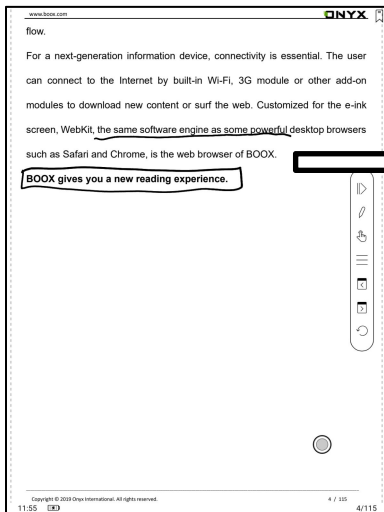

Converted to adding Bookmarks

Use stylus to click the upper right corner to add a bookmark

This area does not support page-turn by stylus.

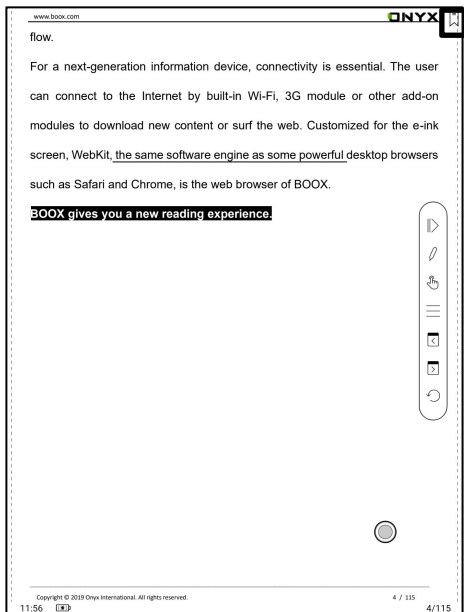

Page-turns

Users can use the stylus to tap the 3 corners of the content area for turning pages. This offers convenience to page-turn when hand touch is disabled.

This function is on by default.

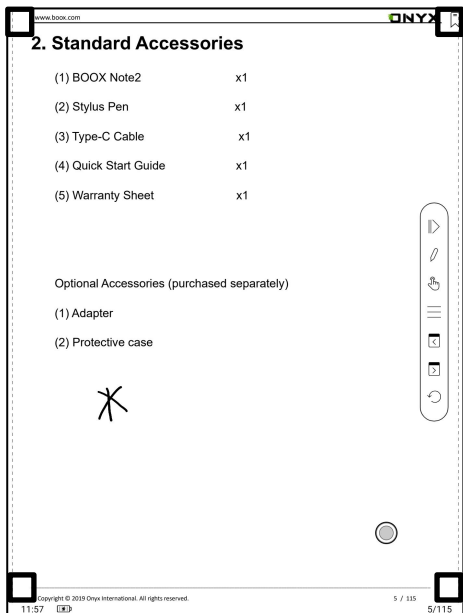

Bottom Menu Bar (PDF format)

This bar includes settings of TOC, Progress, Layout, Contrast, Navigation, Split-Views.

TOC

TOC contains Table of Content, Bookmark, Annotation, and Scribble.

TOC supports three-layer hierarchy. The current layer is underlined. Jump to the corresponding page when tapping any of the layers.

Tap on any position out of the TOC to exit.

The image shows a PDF viewer interface. On the left is a Table of Contents (TOC) with the following items:

AS YOU LIKE IT	1
1601	1
ACT I.	3
SCENE I. Orchard of OLIVER'S house	4
SCENE II. A lawn b...the DUKE'S palace	8
SCENE III. The DUKE'S palace	14
ACT II.	18
SCENE I. The Forest of Arden	19
SCENE II. The DUKE'S palace	21
SCENE III. Before OLIVER'S house	22
SCENE IV. The Forest of Arden	24
SCENE V. Another part of the forest	26
SCENE VI. The forest	28
SCENE VII. The forest	29
ACT III.	33
SCENE I. The palace	34
SCENE II. The fore...DQ, with a paper	35
SCENE III. The forest	43
SCENE IV. The forest	46
SCENE V. Another part of the forest	48
ACT IV.	52

The right side shows a preview of the page. The title is "LIKE IT" and the author is "Shakespeare". The page number is "601". A vertical dashed line is on the right side of the preview. A circular icon is on the right side of the preview.

The bottom menu bar contains the following icons: a list icon, a bookmark icon, a settings icon, and a scribble icon. The page number "1/74" is visible at the bottom right.

Order

Full screen

Bookmarks

Without calling out the menu, bookmark the reading page by simply tapping a tag on the top right corner of the screen. Tap it again to un-bookmark the page.

The bookmarks can be checked under the path of Doc-Bookmark, where users can delete bookmarks.

Jump to the corresponding page by tapping any of the bookmarks.

Annotation

All highlighted/underlined/annotated content would be listed under the page of Doc-Notes for further searching, editing and deleting.

Jump to the corresponding page/content by tapping any of the lists.

All contents on the Annotation page can be exported in txt format. Exported files are saved under the directory folder Storage\Note\ (same name as the source file).

Scribble

All scribble and sidenote can be viewed under the page of Doc-scribble for further searching and deleting.

Jump to the corresponding page by tapping any of the pages.

All scribble contents can be exported in Png format and saved under the same directory folder Storage\Note\(same name as the source file).

Progress

It displays the chapter name (book name if no chapter), page progress, last/next chapter, page number, slideshow, undo, and redo.

Tap on the page number to enter a quick-flip interface. Click the page numbers again and input number to jump to the page directly.

PDF files support for searching and using the files' own page number (custom page number type)

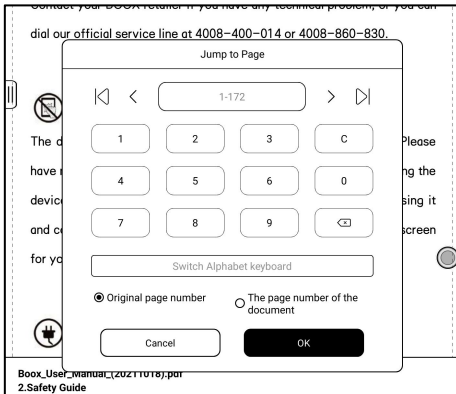

Format

This includes settings of Paging, Zoom, Crop, and Margin.

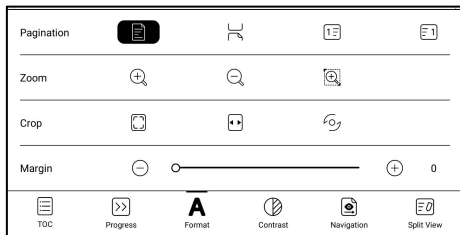

Pagination:

There are options of Single page, Double–page 1, and Double–page 2.

Double–page mode only supports horizontal screen.

Zoom:

Zoom in, zoom out, and partial zoom are supported. Users can also pinch fingers together or apart to zoom out or in on the reading pages.

When a single page exceeds the display area of the screen after zooming, you can long press and drag the display area around. Single tap is to turn sub–pages. You need to use the virtual page–turn buttons to turn the

original whole page;

Crop:

Auto-crop according to the margin set by users.

Margin:

The empty space at the sides of book content for auto crop.

Margin:

The default reserved blank area during automatic cropping. You can manually modify the automatic cropping area.

Contrast

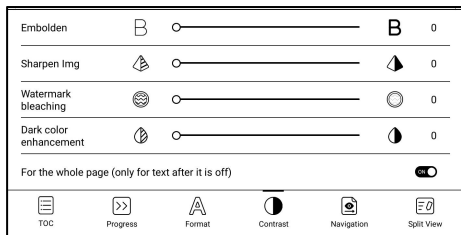

Embolden only applies to text in PDF.

Sharpen Image can sharpen the images.

Watermark Whitening can whiten the light-colored images or background in the pages.

Dark Color Enhancement applies darker display to either the whole pages or text only.

Navigation

Navigation allows users to have options of Reset, Comic Mode, Article Mode, and More Settings including Crop, Split, and Subpage Order.

Comic Mode: the screen will be divided into four subpages and the reading order is upper right – upper left – bottom right – bottom left.

Article Mode: the screen will be divided into four subpages and the reading order is upper left – bottom left – upper right – bottom right.

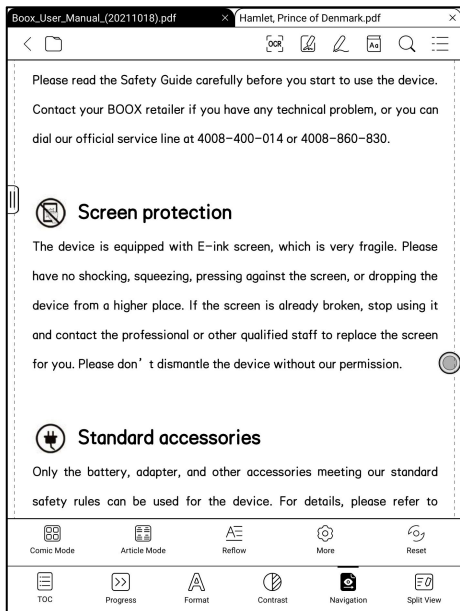

More settings

Manually adjust the settings of area cropping, page split, and subpage order.

Crop: Manually select the cropping area for single or double pages.

Split: Split the pages into specified subpages in different ways.

Order: Decide the initial position and reading order for subpages.

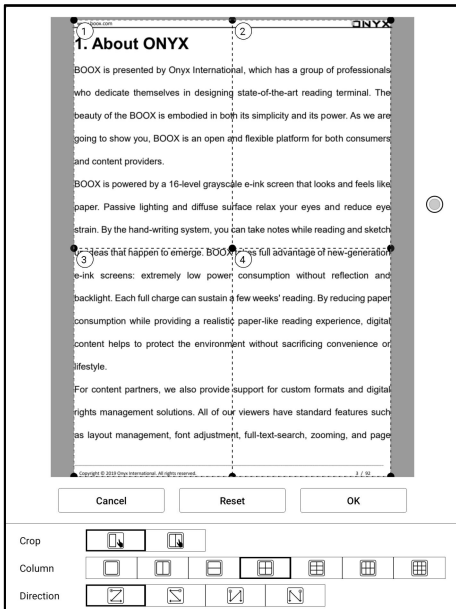









Reflow

Reflow now supports both scanned and text versions.

Reflow is only available for PDF/DJVU/CBR/CBZ documents.

Scan Type

Reflow allows users to further customize the layout of documents including: Line Spacing, Margin, Text Direction, Font Size, Columns, and Skew Correction (for italic documents).

	Scan Type	Text Type		
Text Direction	<input checked="" type="radio"/> A	<input type="radio"/> A	<input type="radio"/> A	<input type="radio"/>
Spacing	<input checked="" type="radio"/> 	<input type="radio"/> 	<input type="radio"/> 	<input type="radio"/>
Alignment style	<input type="radio"/> 	<input checked="" type="radio"/> 	<input type="radio"/> 	<input type="radio"/>
Font size	<input checked="" type="radio"/> 0.75	<input type="radio"/> 1.0	<input type="radio"/> 1.2	<input type="radio"/> 1.5
Columns	<input type="radio"/> 	<input checked="" type="radio"/> 	<input type="radio"/> 	<input type="radio"/>
Tilting Correction	<input checked="" type="radio"/> 0	<input type="radio"/> 5	<input type="radio"/> 10	<input type="radio"/>
	<input type="button" value="Reset"/>	<input type="button" value="OK"/>		

Text Type

Applicable to the digital PDFs or PDFs that have been recognized by OCR (you can press and hold to look up words) PDF. The reflowed files can use the features of flow documents.

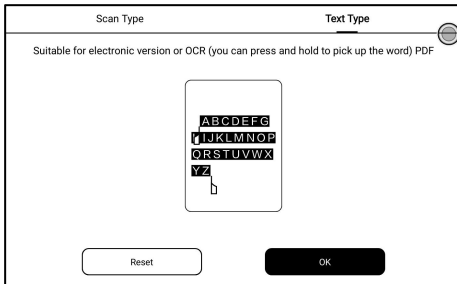

Split View

It allows to respectively open current document, two different documents, or one document & Note at the same time、Split-View (Doc & Translation) ;

Split-View now supports both Horizontal Mode and Vertical Mode. You can swap sides of the two windows.

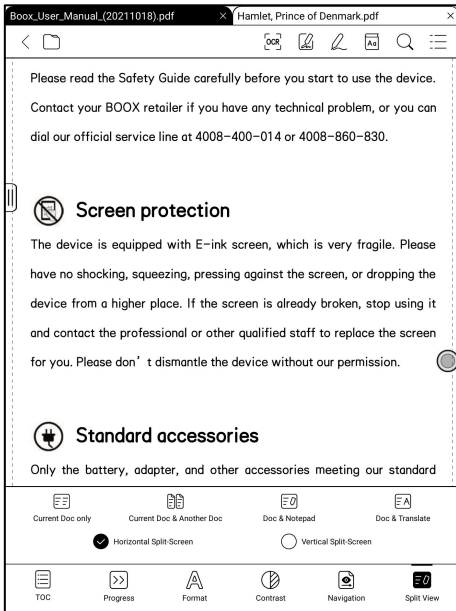

Current Doc (same doc)

The two documents are totally independent. Users can respectively turn pages and save them.

The scribble, highlight, annotation, bookmark would be synchronized to each other after page refresh.

ONYX	ONYX
<p>1. About ONYX</p> <p>BOOX is presented by Onyx International, which has a group of professionals who dedicate themselves in designing state-of-the-art reading terminal. The beauty of the BOOX is embodied in both its simplicity and its power. As we are going to show you, BOOX is an open and flexible platform for both consumers and content providers.</p> <p>BOOX is powered by a 16-level grayscale e-ink screen that looks and feels like paper. Passive lighting and diffuse surface relax your eyes and reduce eye strain. By the hand-writing system, you can take notes while reading and sketch up ideas that happen to emerge. BOOX takes full advantage of new-generation e-ink screens: extremely low power consumption without reflection and backlight. Each full charge can sustain a few weeks' reading. By reducing paper consumption while providing a realistic paper-like reading experience, digital content helps to protect the environment without sacrificing convenience or lifestyle.</p> <p>For content partners, we also provide support for custom formats and digital rights management solutions. All of our viewers have standard features such as layout management, font adjustment, full-text-search, zooming, and page</p> <p>15:00 3/92</p>	<p>1. About ONYX</p> <p>BOOX is presented by Onyx International, which has a group of professionals who dedicate themselves in designing state-of-the-art reading terminal. The beauty of the BOOX is embodied in both its simplicity and its power. As we are going to show you, BOOX is an open and flexible platform for both consumers and content providers.</p> <p>BOOX is powered by a 16-level grayscale e-ink screen that looks and feels like paper. Passive lighting and diffuse surface relax your eyes and reduce eye strain. By the hand-writing system, you can take notes while reading and sketch up ideas that happen to emerge. BOOX takes full advantage of new-generation e-ink screens: extremely low power consumption without reflection and backlight. Each full charge can sustain a few weeks' reading. By reducing paper consumption while providing a realistic paper-like reading experience, digital content helps to protect the environment without sacrificing convenience or lifestyle.</p> <p>For content partners, we also provide support for custom formats and digital rights management solutions. All of our viewers have standard features such as layout management, font adjustment, full-text-search, zooming, and page</p> <p>15:00 3/92</p>

Different Docs

Choose a document different from the current document.

www.boox.com **ONYX**

1. About ONYX

BOOX is presented by Onyx International, which has a group of professionals who dedicate themselves in designing state-of-the-art reading terminal. The beauty of the BOOX is embodied in both its simplicity and its power. As we are going to show you, BOOX is a reading terminal that is designed for consumers and content providers. BOOX is powerful and feels like a piece of paper. Passivity is not a strain. By the way, BOOX is a multi-generation device. BOOX is a reflection and a breakthrough. BOOX is reducing paper consumption. BOOX is a convenience or a lifestyle.

For content partners, we also provide support for custom formats and digital rights management solutions. All of our viewers have standard features such as layout management, font adjustment, full-text-search, zooming, and page

Copyright © 2019 Onyx International. All rights reserved. 3 / 92

15:00 3/92

Different Doc

- Recently read
- Storage
 - EN-book
 - as you like it.pdf
 - Hamlet, Prince of Denmark.pdf
 - a midsummer night's dream.pdf
- Books
- Push
- Download
- note
- Shop
- WifiTransfer

1/1

Similar to the Current Doc, these two documents can be respectively operated. The display is also swappable. For PDF document, please try to swap them if part of them is not writable.

The screenshot displays a digital reading application interface. On the left, a document titled "1. About ONYX" is visible, containing text about the device's features and power consumption. A settings menu is open over this document, showing options for "Screen Refresh", "Swap", and "Settings". Below the document, a PDF viewer shows the "Boox Max2 Series User Manual (20190410).pdf" with a progress indicator at 3/92. At the bottom, there are icons for "TOC", "Progress", "Format", and "Scribble". On the right, a document titled "THE TRAGEDY OF HAMLET, PRINCE OF DENMARK" is displayed, featuring the title "HAMLET, PRINCE OF DENMARK" and the author "William Shakespeare 1604". The page number "15.01" and a small icon are visible at the bottom of this document.

1. **About ONYX**

BOOX is presented by Onyx International, which has a group of people who dedicate themselves in designing state-of-the-art reading devices. The beauty of the BOOX is embodied in both its simplicity and its flexibility. Going to show you, BOOX is an open and flexible platform for both consumers and content providers.

BOOX is powered by a 16-level grayscale e-ink screen that looks and feels like paper. Passive lighting and diffuse surface relax your eyes and reduce eye strain. By the hand-writing system, you can take notes while reading and sketch up ideas that happen to emerge. **BOOX takes full advantage of new-generation e-ink screens: extremely low power consumption, without reflection and backlight. Each full charge can sustain a few weeks' reading.** By reducing paper consumption while providing a realistic paper-like reading experience, digital content helps to protect the environment without sacrificing convenience or lifestyle.

For content partners, we also provide support for custom formats and digital content.

Boox Max2 Series User Manual (20190410).pdf 3/92

TOC Progress Format Scribble

15.01 ED 1/91

Doc & Note

Likewise, they are swappable.

And the Note will be created with a name same as the document. It associates with the document and can be edited in Note app.

Every document can only have an associated note. Changing the name of the note does not affect the association.

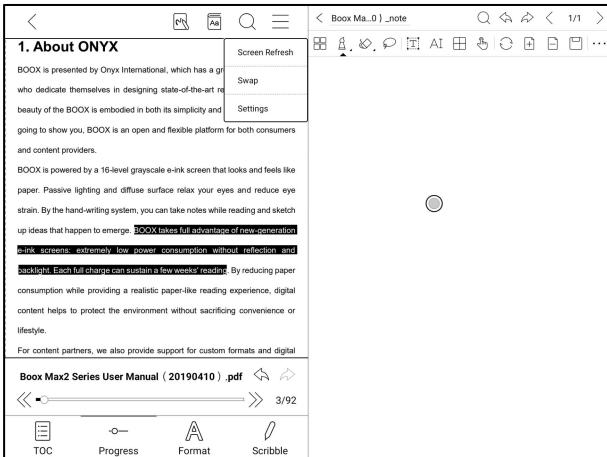

Split-View (Doc & Translation)

This supports Baidu Translate and Bing Translate and provides full page translation.

This also supports multiple target languages;

Your BOOX needs to stay connected with internet;

Some translation engines have a limit on the number of words per day.

Please see the tips on the translation page for details;

Bottom Menu (other formats)

This includes settings of TOC, Progress, Format, Contrast, and Split View and supports flow formats such as EPUB\TXT\MOBI\AZW3.

V2 Engine

Some flow formats (ePub\mobi\azw3\txt\word\jeb\html) use V2 engine by default. Go to Reading Settings/Other Settings to switch to NeoReader V2 engine supports the original layout of the document, including font, line spacing, margin, graphic typesetting, indentation, etc.;

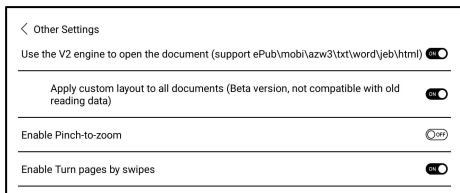

After being switched the V2 engine, the document will be closed automatically, and the V2 engine will be used when you reopen the files; If you need to switch back to NeoReader, you can cancel the V2 engine and reopen the document;

V2 engine does not support to sync data from NeoReader such as Bookmarks, Annotations, and Handwritten notes.

Progress

The document needs to be paginated again after switched to V2 engine, or font and spacing adjustment. You can check the pagination progress in the reading Menu>Progress. After the progress bar is loaded, it means the pagination is completed. You can drag the progress bar to jump pages after the pagination is completed.

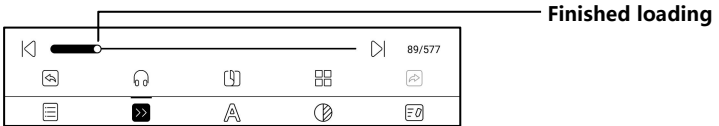
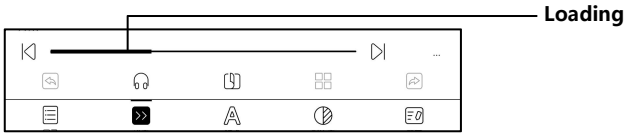

Format

The settings include Font Face, Display and Spacing.

Loading font face in the directory Storage\fronts is supported.

The settings for font size, font face, contrast, bold, spacing work on all newly opened documents, but not work on the documents before settings.

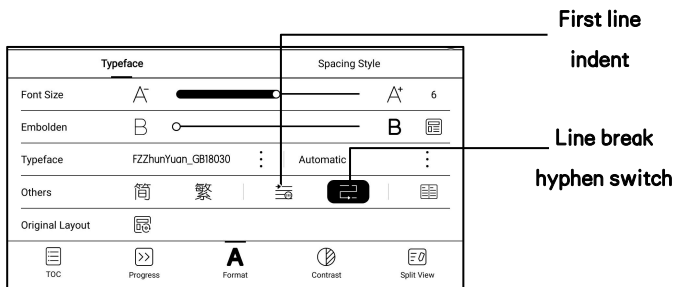

Screenshot

Diagonally tap on two corners of the screen to capture the screen in PNG format. The function is only available on the reading page.

The screenshot will be saved to the local, or shared by scanning QR code.

The save path is Storage\Screenshots.

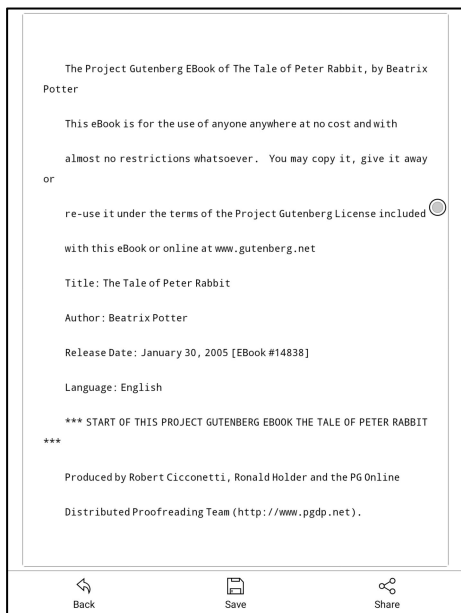

Refresh

Tap the hamburger menu located at the upper right corner to choose

Refresh and other related settings of refresh

Regal refresh and partial refresh are by default

When scrolling the page, speed mode is by default.

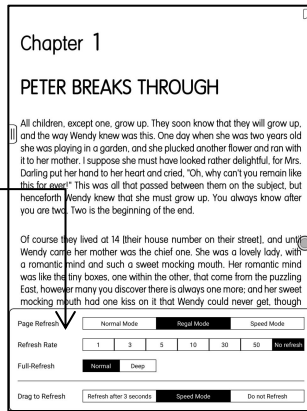
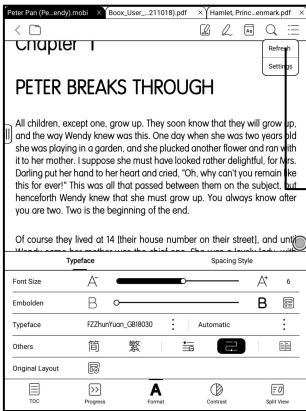

Settings

There are General Settings, Touch Settings, TTS Settings, Export Settings, Screenshot Settings, Floating Toolbar Settings 、 Other Settings and Version Name.

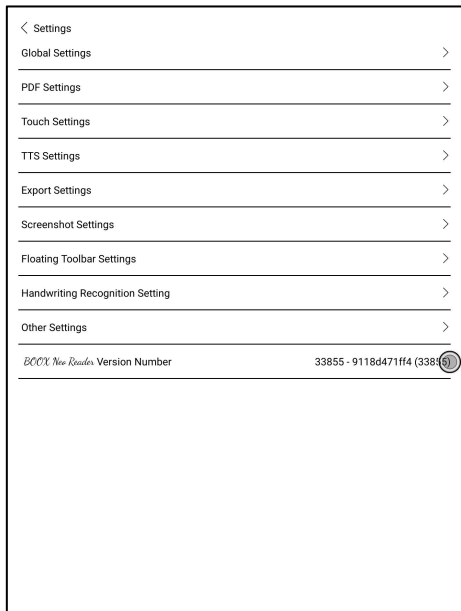

General Settings

There are Enable page close reminder, Enable system status bar, Enable reader status bar, Enable multiple documents, Show file borderline, Enable Floating Toolbar, Show hyperlink, Show bookmark position, Apply certain options to all documents、 Annotation Font Size Setting; .

Global Settings	
Show close reminder when exiting	<input type="checkbox"/>
Enable reading Status Bar	<input checked="" type="checkbox"/>
Page number displayed as a percentage	<input type="checkbox"/>
Show battery percentage	<input type="checkbox"/>
Enable multiple documents	<input checked="" type="checkbox"/>
PDF auto-crop margins(Take effect when newly opened or switch between landscape and portrait)	<input type="checkbox"/>
PDF auto scale to width	<input checked="" type="checkbox"/>
Show file's borderline	<input checked="" type="checkbox"/>
Show page break line	<input checked="" type="checkbox"/>
Show hyperlink	<input checked="" type="checkbox"/>
Show Bookmark's location	<input checked="" type="checkbox"/>
Show Books' titles instead of filenames	<input type="checkbox"/>
Apply Font, Contrast, Spacing Style settings to all files	<input checked="" type="checkbox"/>
Annotation font size setting	Standard >

Touch Settings

Users are able to customize the touch settings for different areas. There are six default touch modes can be chosen and users can customize three more.

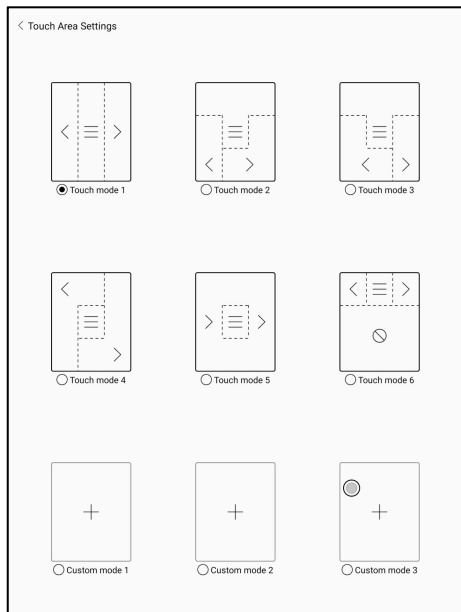

TTS Settings

The built-in Baidu TTS is set by default. English is supported. A network connection is required at first use.

Switching to third-party TTS system is allowed. The built-in TTS settings are not synchronized with the system TTS settings. The system TTS settings work on the third-party TTS by default.

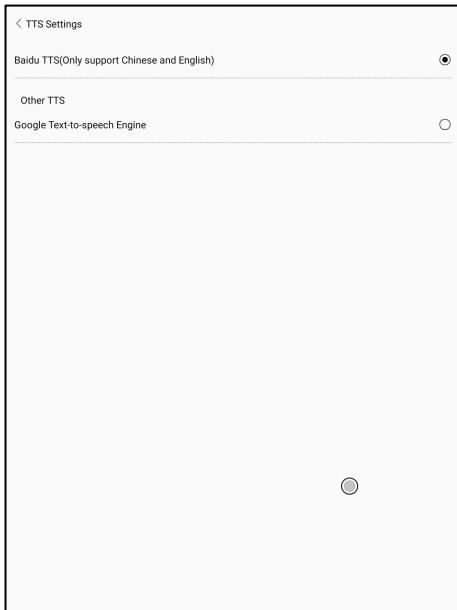

Export Settings

The default storage path is Storage\Note.

The export files can be also saved to the same directory as the source file.

< Export settings

Export Settings >

Default path: \Storage\note

Saved to the same directory as the source file

○

Floating Toolbar Settings

This page offers General Settings of Floating Toolbar, Scribble Settings, and Handwriting Recognition Settings;

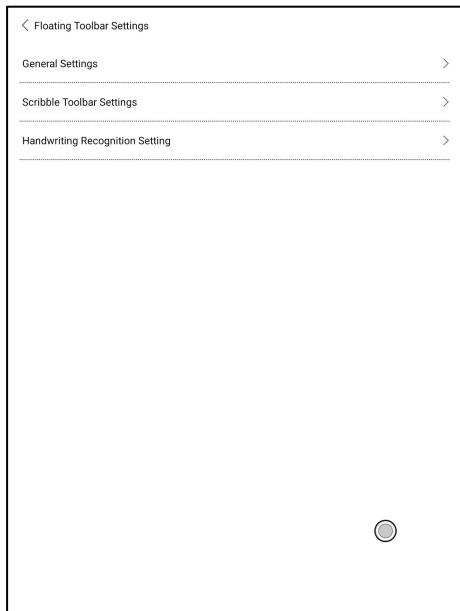

General Settings

It is enabled by default and can be turned off manually. After disabled, it can no longer be called out;

It can be customized whether the indicator is displayed after it is collapsed. Call out the Floating Toolbar by swiping from the screen edges.

The Toolbar's size, display style and functions buttons are customizable.

Custom function buttons support up to 11 in horizontal style and up to 14 in vertical style;

Press and hold the function button icon to display the definition of the function button;

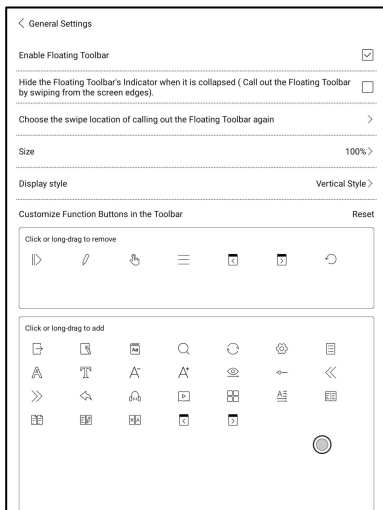

Scribble Toolbar Settings

The Toolbar's size, display style and function buttons are customizable.







< Scribble Toolbar Settings





Size 100%>

Display style Horizontal Style>





Customize Function Buttons in the Toolbar Reset

Click or long-drag to remove

Click or long-drag to add



Handwriting Recognition Settings

It is enabled by default and can be disabled manually. After disabled, it will no longer support double-tap recognition

The underline can be recognized as highlight first. It is enabled by default, and it can be turned off. After it is turned off, it is only recognized as an image;

You can set the recognition of hand-drawn symbols as adding bookmarks. It is disabled by default and can be manually enabled. After enabling, double-tap recognition of the symbol will automatically convert to adding bookmarks;

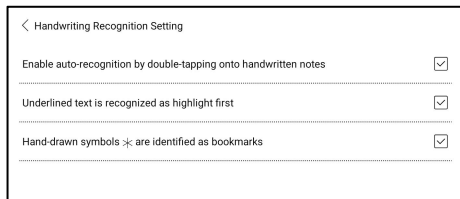

Other Settings

This setting page includes “Open ePUB documents with V2 engine” , Enable “Pinch-to-Zoom” , and Enable “Turn pages by swipes”

When “Turn pages by swipes” is disabled, you can only turn pages by tapping on the screen. This can avoid accidental page-turnings when you are taking handwritten notes.

Other Setting	
Open Epub Document with V2 Engine	<input checked="" type="checkbox"/>
Custom layout is applied to all Epub documents(The beta version is temporarily not compatible with old data)	
Enable Pinch-to-Zoom	<input type="checkbox"/>
Enable Turn pages by swipes	<input checked="" type="checkbox"/>

7. Store

In the language of non-Chinese, the Store is offering free publications E-books from the Internet.

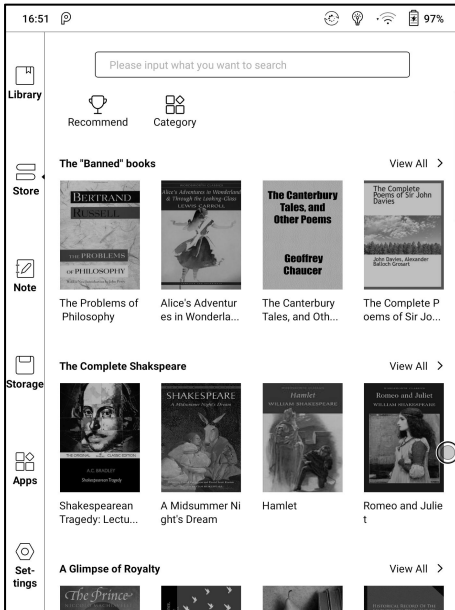

Category

Books can be screened according to different categories.

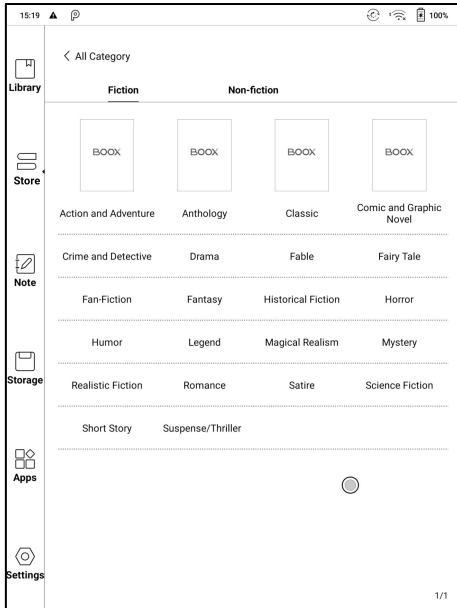

Book Detail

Click a book cover to open up book detail. The specific book information.

Click “Full Edition Download” to download the book, then you can see this book cover in Library .

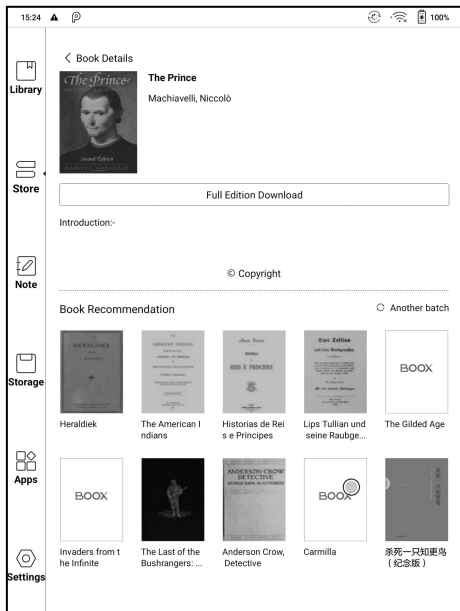

8. Notes

This includes Recent Notepads, Local Notepads, and Reading Notes.

Recent Notepads include 12 Notepads that have been opened recently, including local notepads and reading Notes

The Reading Notes include the Notes created under Split View when users are reading books.

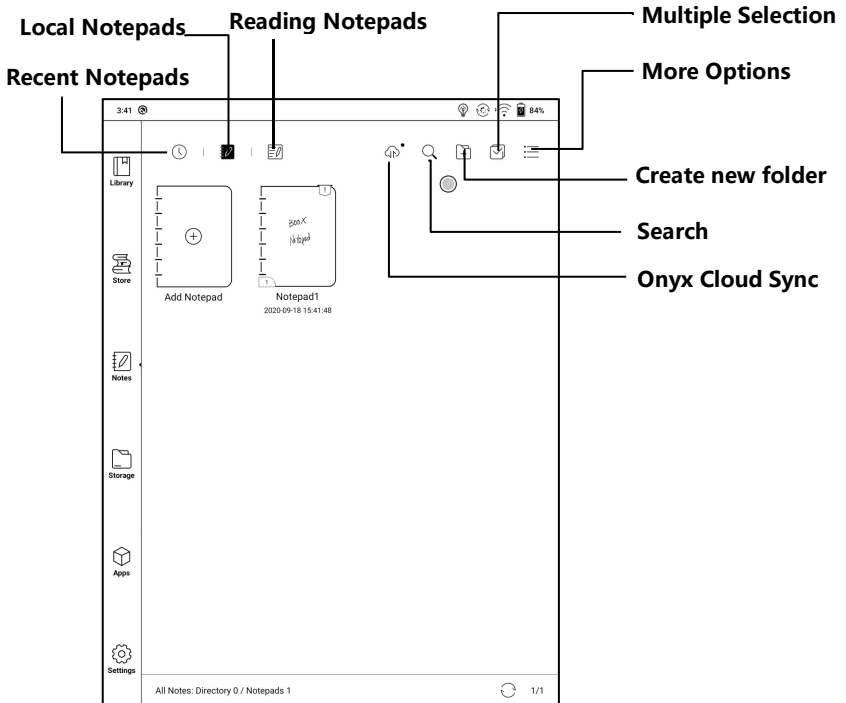

Cloud Sync (in bulk)

Notes Cloud Sync requires logging in to Onyx Account.

Sync in the background. After you are logged in to ONYX account, the notes will be automatically synced from and to Cloud when you exit a Notepad.

Sync in bulk, including Notes list, all Notes. Users can manually sync all notes in bulks.

Cloud Sync includes two-way sync between Cloud end and BOOX device. When there is any change to the Notes on either end, the other end will sync all the changes.

The deleted Notepads can be recovered within 10 days from website trash bin. If you delete the notepads by mistake, you can recover them from the trash bin, which will be emptied after 10 days.

After Notes are synced, users can check the synced notes from push.boox.com by logging in the same Onyx Account.

Currently PDF templates cannot be synced and only PNG templates can be synced.

Other accounts Sync

When third-party accounts are bound, the notes will be automatically synced when you exit a Notepad. Alternatively, you can sync notes by tapping the Sync icon on the top bar.

Third-party accounts only support one-way sync and do not support syncing notes back to BOOX devices. You do not need to log in to ONYX account.

Sync Results

Long press the cover of the Notepad to pop up the Property Window and check the synced accounts and sync result list.

Tap the sync icon to sync again for the accounts with abnormal sync.

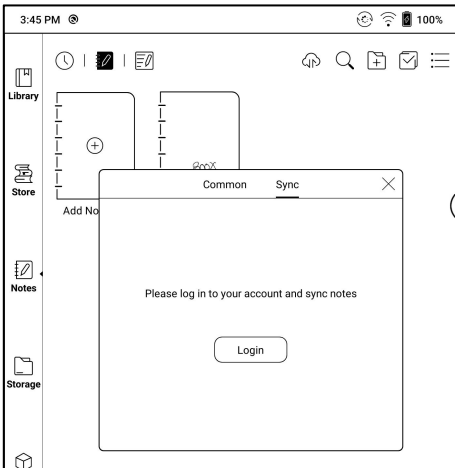

More Options

This includes Sort By, List Mode, Sync Settings, and Option Settings.

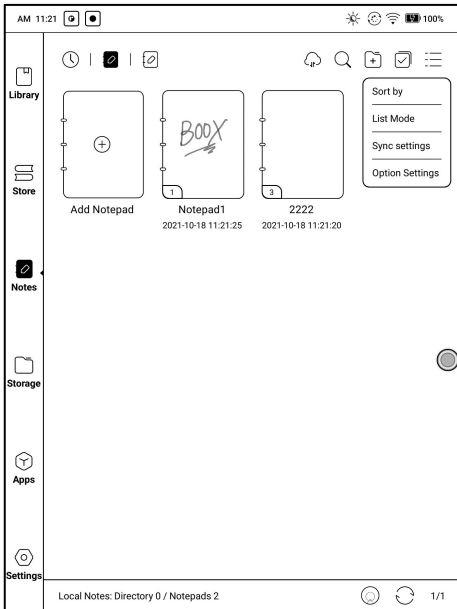

Notes Sync Setting

This includes ONYX Cloud Notes and export to other accounts.

When you export the Notes to third-party Accounts, the Notepads will be in PDF format and cannot be edited.

If you export your notes to other bound accounts, the notes will be automatically synchronized to other bound cloud accounts of yours when you exit the Note. The sync icon is only applicable for the ONYX account cloud sync.

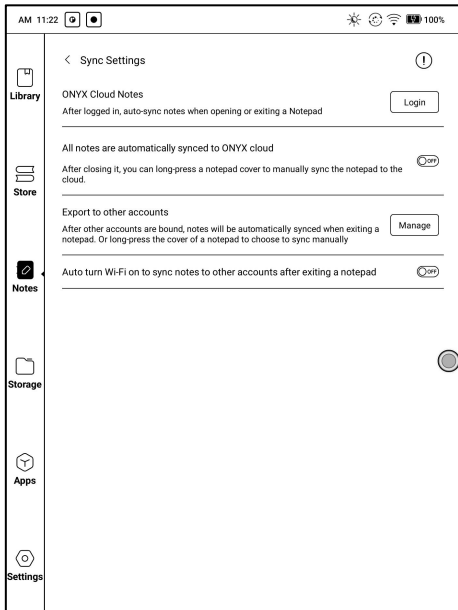

Backup and Recover

It supports backup and recovery of notes locally and does not support Cloud backup.

Note: The action Recovery will recover the backup data, which will overwrite the current data. Please be careful.

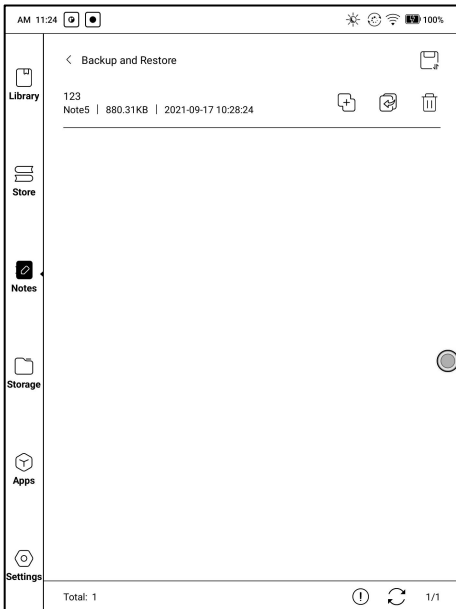

Settings

These are general settings for Stylus Calibration, Account Sync and Backup, AI recognition, Notepad password settings, Show Erasing Trace, Auto-turn on Wi-Fi to sync Notes, Auto-generate PDF documents after exiting Note, Auto refresh after lifting stylus.

If this device is bound with third-party accounts for file sync, and Wi-Fi is connected, the Note files will be auto-uploaded to the accounts with a PDF or PNG attachment.

If “auto-turn on Wi-Fi to sync Notes” is enabled for notes sync, the device will connect with Wi-Fi automatically and sync notes to the Cloud when exiting the Note app. If it is disabled, users need to sync to account manually by clicking an upload icon on book covers.

For the “Auto refresh after lifting stylus”, the display would refresh after users lift stylus away from the screen, making the strokes smoother.

Notepad Password Settings

This password is only used for protecting files on the device, not encrypting files. So, the password does not work out of the device. Now this function does not support multiple passwords for one file.

This function supports specific password, which are available for all note files. Users can also set a specific password for a single file. To add, edit and remove password are allowed here.

The specific password can be different from the system password.

Separate numeric password allows you to choose whether to add locks to new notepads. If you cancel this option, the new notepads will not be automatically added locks. You need to add them manually later.

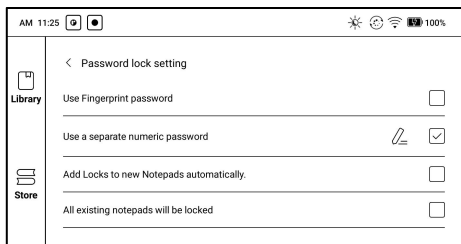

The note file has no cover thumbnail after locked.

Long-press the note file to remove and add password in the dialog.

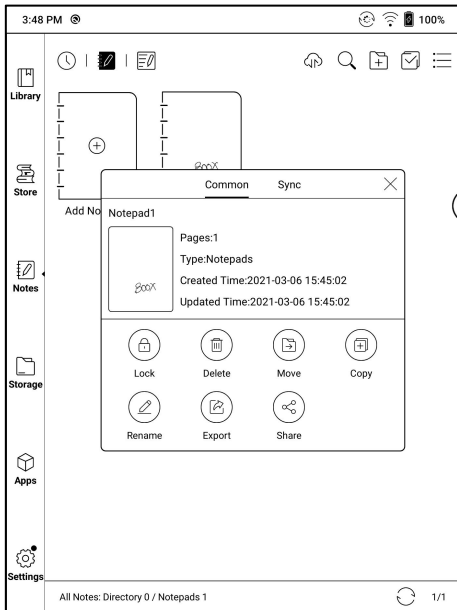

Scribble Interface

Files can be saved automatically and manually when to quit the Note.

Tap on the page number to jump to the specified page quickly.

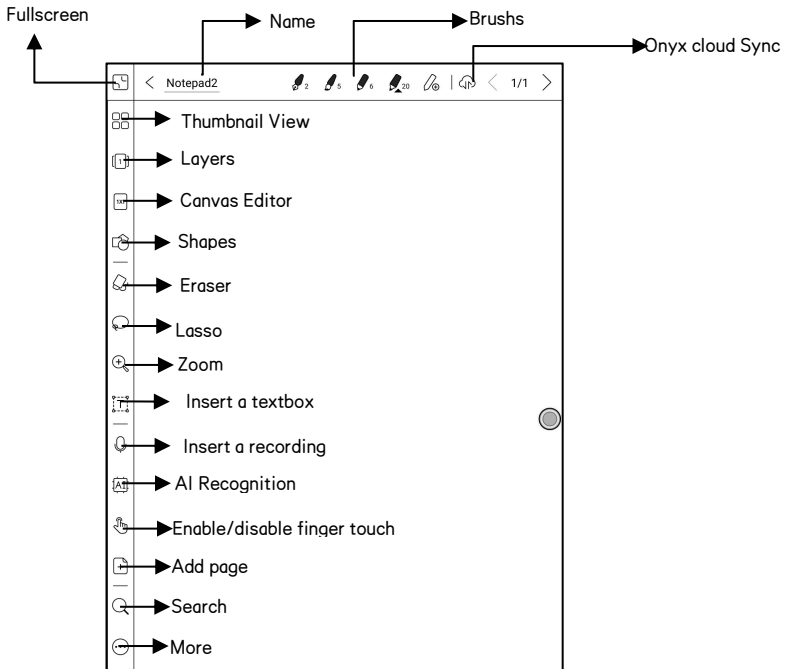

Layers

This supports template layer, 5 custom layers, hiding and adjusting layer order.

Hidden layers will not be displayed during export and recognition;

Templates can only be added at the template layer, and the template layer cannot be deleted;

You can add 5 custom layers to the inserted images

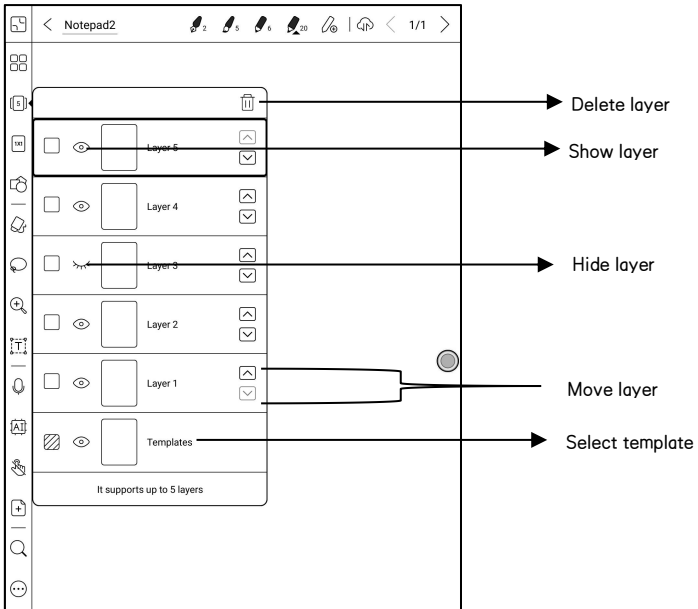

Templates

The settings of Templates include Scaling, Original image splice, Stretch to cover all, Original size and Fit canvas.

It is recommended to write after the template style is determined to avoid changes in the templates after writing.

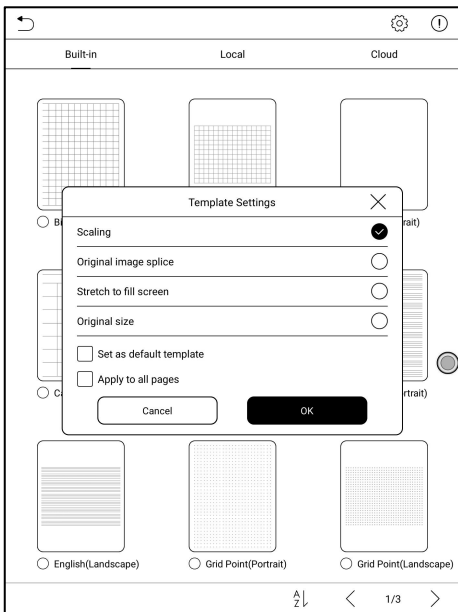

Canvas Editor

The default canvas size is 1x1, same as the screen size.

The canvas size can be adjusted to 1x2, 2x1, 2x2 or custom size.

The max canvas size is 2x2. You can customize the canvas size within the max size. You can adjust the canvas size by dragging the canvas.

Canvas adjustment base is located at upper left corner. Drag left or downwards to expand the canvas.

When you switch from the large canvas to the small canvas, the strokes outside the canvas range will not be displayed, but will not be cleared. But the strokes can be redisplayed after you switch back to the large canvas

Canvas Adjustment will cut the redundant blank part of the canvas based on the outermost strokes position.

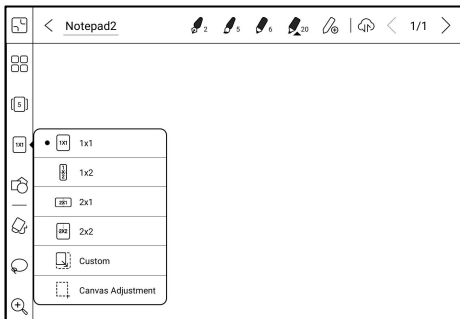

Horizontal Notepad

The notepad orientation is synchronized with the system rotation direction. When the system is switched to the horizontal screen, the notepads are synchronized to the horizontal screen. The created notepad under the vertical mode will retain its vertical size. The canvas size can be manually adjusted;

The newly created notepad in horizontal mode directly uses the canvas size 1x1;

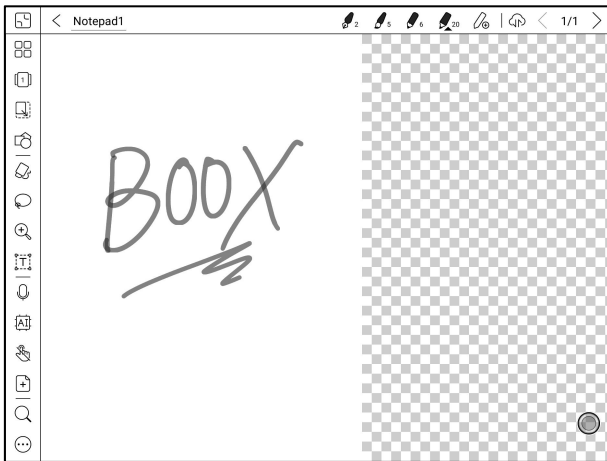

Brushes

You can add 5 custom brushes. You can set type, color, and line width of each brush. Double tap the icon to expand the secondary menu for more options.

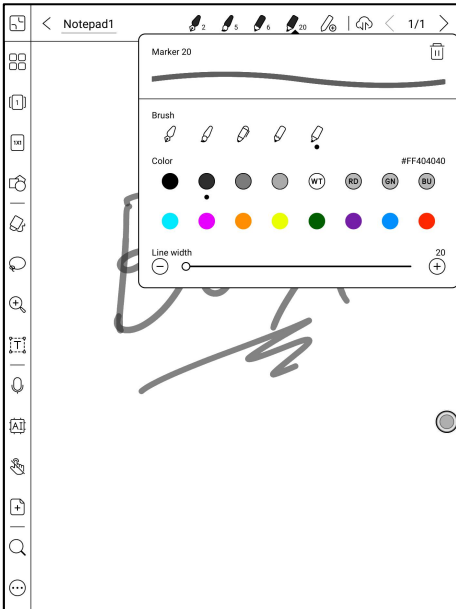

Fit to Canvas and Fit to Screen

When the canvas is larger than the screen(1x1), you can go to Toolbar / Zoom to adjust the canvas size to “Fit-to-canvas” or “Fit-to-screen”.

Fit-to-canvas: the canvas will be automatically expanded to fit the whole screen. When the canvas is larger than screen, you can long press the canvas to pan it around.

Fit to screen: the canvas will zoom out to fit to screen. You cannot write on the grey area.

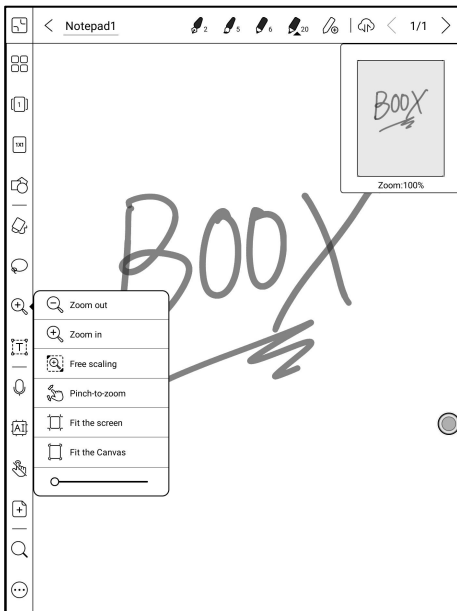

Custom Toolbar

Besides the default tools like scribble, erase, fullscreen, select, users can add, remove, adjust other tools on the toolbar.

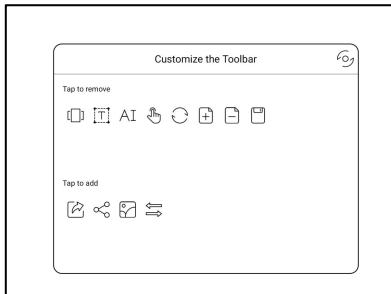

Erase

In the state of stroke erasing, you need to switch to the brush first and then write.

For the “erase all” , you do not need to switch back to the brush.

Lasso

In the Lasso mode, circle an area on the screen, then users can zoom, move, duplicate and remove the selected area.

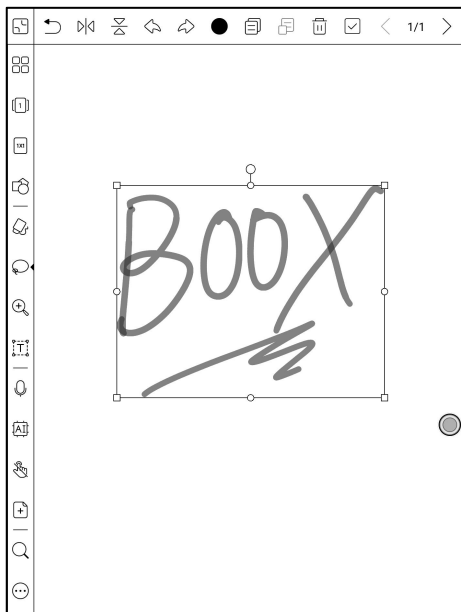

Text Input

Users are allowed to key in words on the note by a Bluetooth keyboard.

The input box can be moved everywhere.

Users can adjust the font, line spacing, bolding, underline, italic, copy and delete.

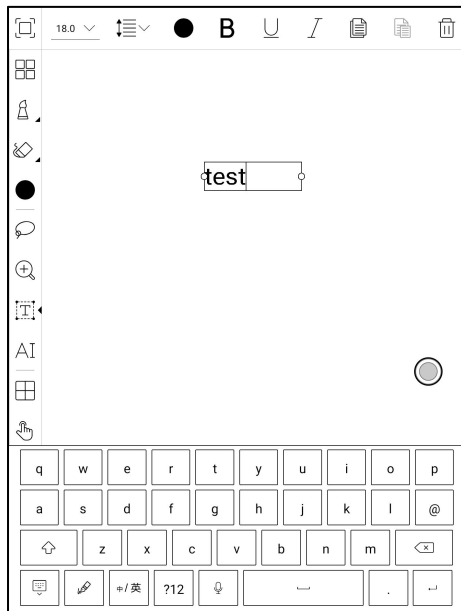

stylus touch for icons is desensitized by default, so it is better to use your

fingers to adjust the position of the Navigation Ball;

when using full-screen the square icon to exit full-screen mode.

Insert a Recording

After tapping the Recording icon, the Recording will start immediately.

The recording progress bar will be shown on the top Toolbar. You can pause the recording. You can take notes while recording.

After stopping the recording, you can save or delete the recording directly.

You cannot restore the recording after you choose to delete it.

The recording window is floating on the screen. You can long press it and drag it around on the screen.

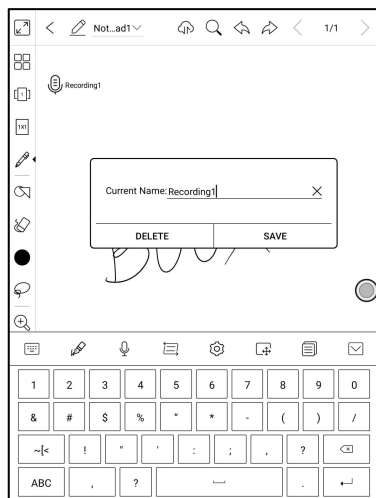
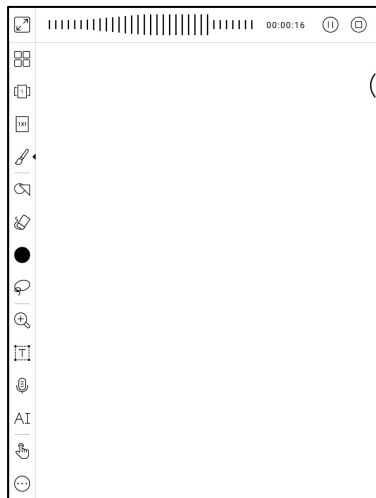

You can insert more than 1 recording on one notepad page.

Check all recordings at Toolbar/More/Recordings. You can only play recordings in current notepad. You cannot export recordings to PDF to use.

If recordings are saved to local storage, you can export recordings in MP3.



Insert Image

Users can remove, zoom, duplicate the images inserted from the local.

Select the image and then edit.

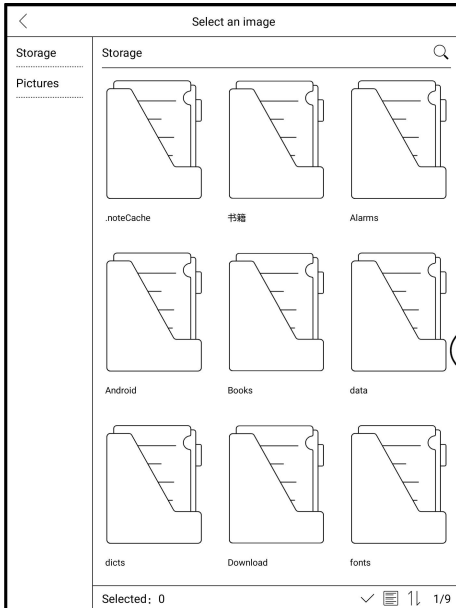

AI Recognition

Click the icon “AI” to switch to recognize the handwriting text. English is supported. To download the corresponding language package is required for other language recognition.

This function contains original recognition and reflow recognition.

Original recognition only does conversion but not changes the position of words, while reflow recognition reflows words after conversion. Users need to manually add space, line break and font size.

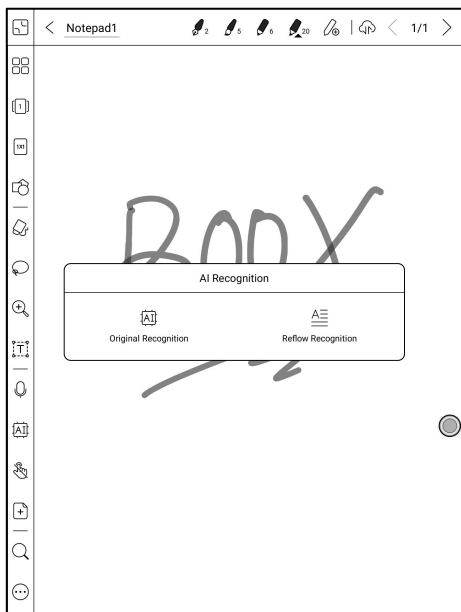

The text flows automatically after reflow. Users can manually make space, newline, and font size after that.

The accuracy of recognition depends on how normal the handwriting is.

AI recognition works based on the handwriting. If the handwriting content changes, please re-enter the function to let it convert once again. For saving the converted content, please export it.

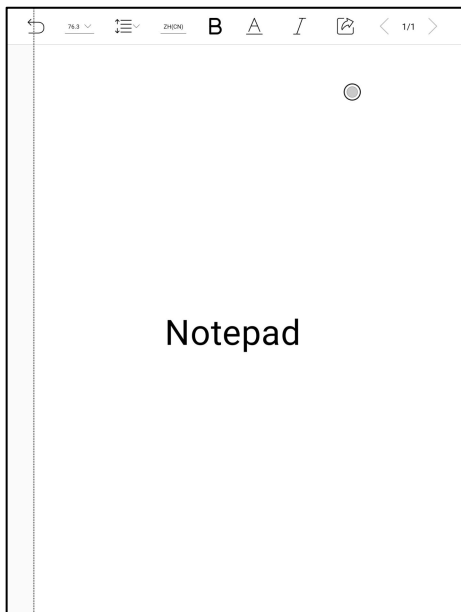

Share

This supports to share all pages (PDF format) and current page (PNG format);

Support scanning code sharing of Onyx account and sharing through third-party app;

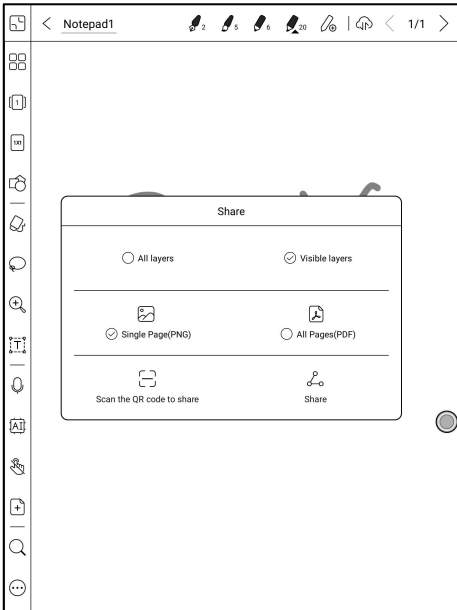

Full screen mode of Notes

When you switch to full-screen mode, you can choose whether to display the Floating Toolbar.

When it is collapsed, you can call it out by swiping from the screen edges.

Note: The full-screen mode is an independent note-taking mode. If you exit, you will exit the Notepad directly. If you need a non-full-screen mode, you can switch on the Toolbar;

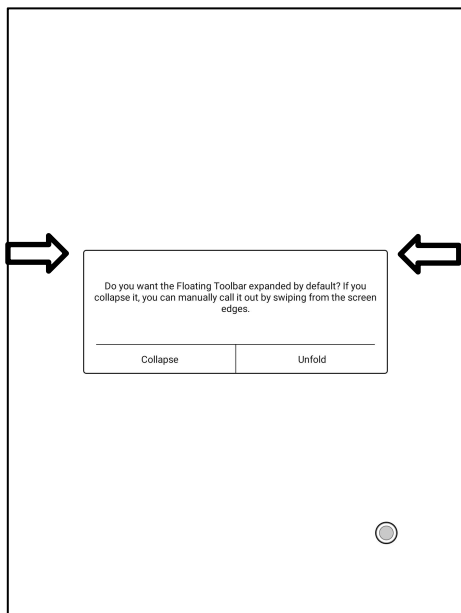

The default Floating Toolbar only includes Fullscreen, Pen, Color, Eraser, Collapse, and More. You can tap the “More” icon to customize the icons on the Floating Toolbar.

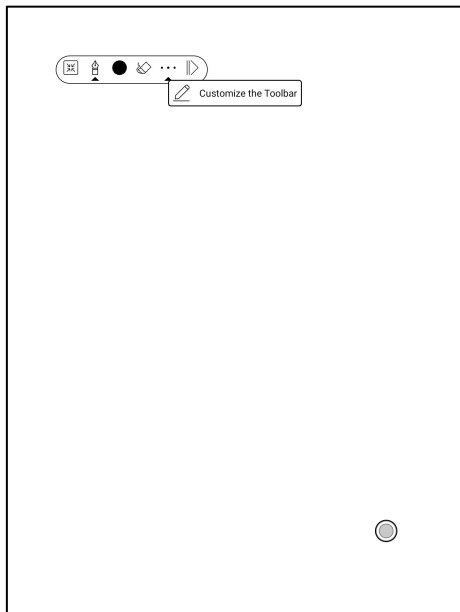

Floating Toolbar Settings

The Toolbar's size, display style and function icons can be customizable.

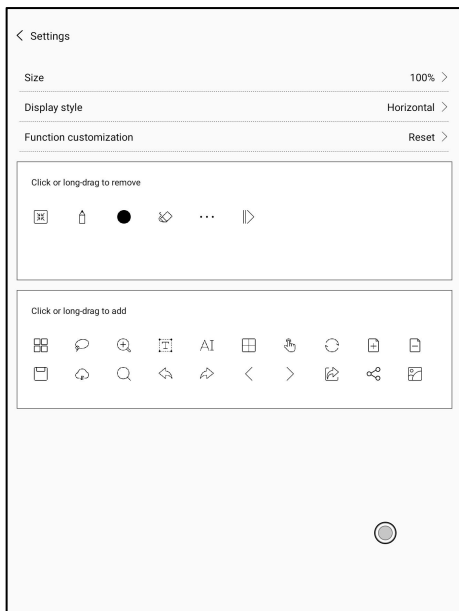

9. Storage

Recent Files

This section includes Shortcuts and Recently Updated Files, which are sorted in reverse order by time.

All Storage

This section includes Storage path and Categories. files will be classified according to the file formats, but the original storage location of the file will not be changed;

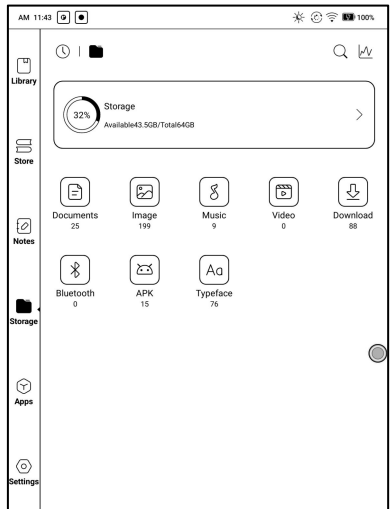
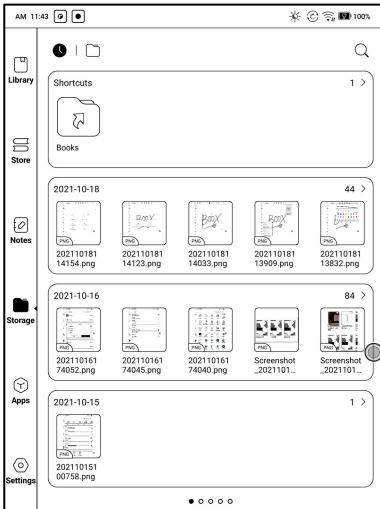

Long-press the folder to pop up Property Window and choose “Set as Shortcut”, which offers quick access to open it.

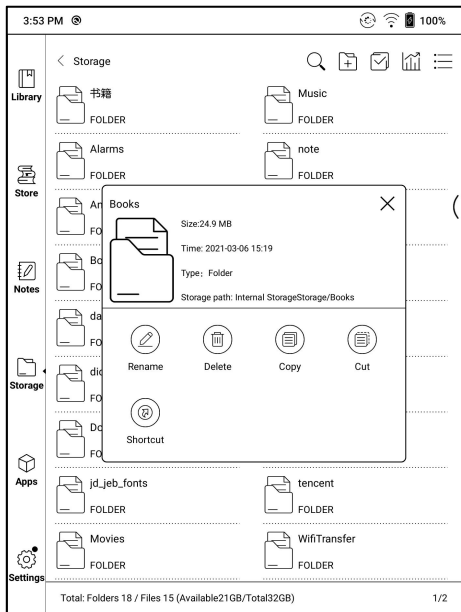

OTG External Disk

OTG is supported. Users can connect the device with USB drive through a Type-C cable. The device will detect USB drive afterwards.

The OTG feature would consume more power since it supplies power to a USB drive.

It supports analog and digital Type-C earphones (You can use 3.5mm audio jack converter);

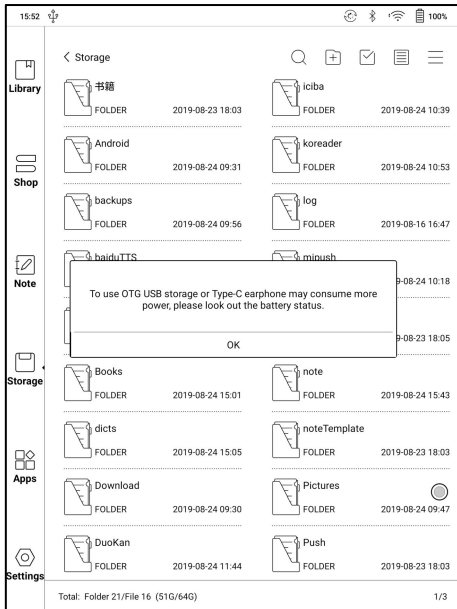

Low storage space warning

Please reserve at least 300M of available storage space to ensure the normal operation of the system and saving related data;

When it is lower than 300M, a warning icon will be displayed in the system bar, indicating that the storage space is insufficient;

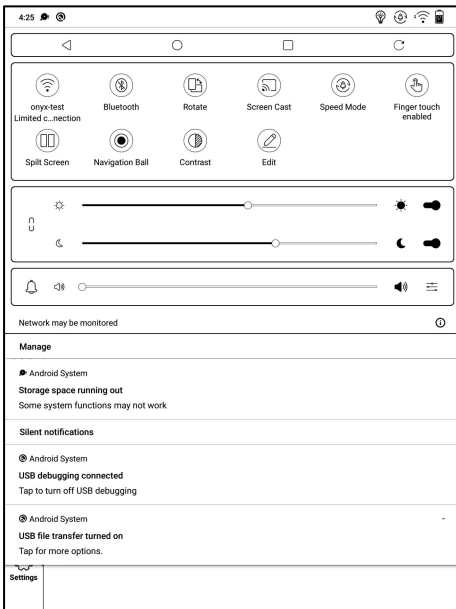

10. Apps

All installed apps are sorted by name by default. You can also sort them by time and manually.

Long press an app to pop up options of Uninstall, Manage, Optimize, and Add to a group

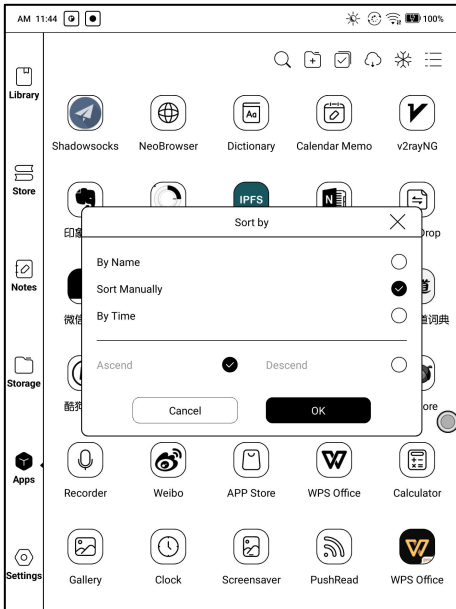

App Management

This page includes USB Debugging Mode, Application Info, Location Settings, Auto-start Settings, Refresh Mode Settings, Freeze Settings, Automatically update the Optimization config of third-party apps, Fill in available space automatically, Enable Google Play.

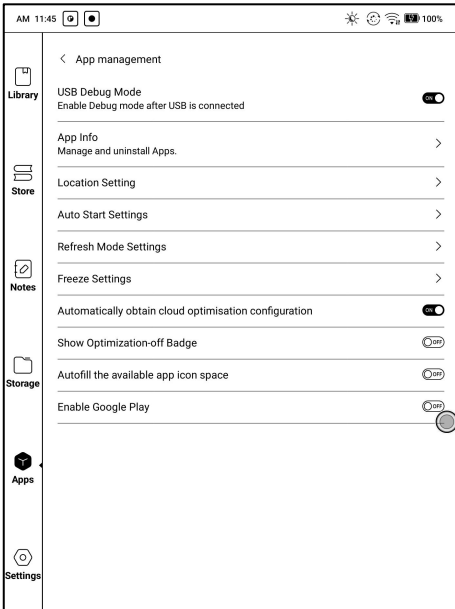

Auto-start Settings

Only applicable to device auto-start. After it is enabled, the applications may take up more storage space and consumes more power.

Apps need to monitor the system start. After apks are installed, you need to tap the app icon to start it once.

After it starts successfully, it only runs in the background and will not show in recent running tasks.

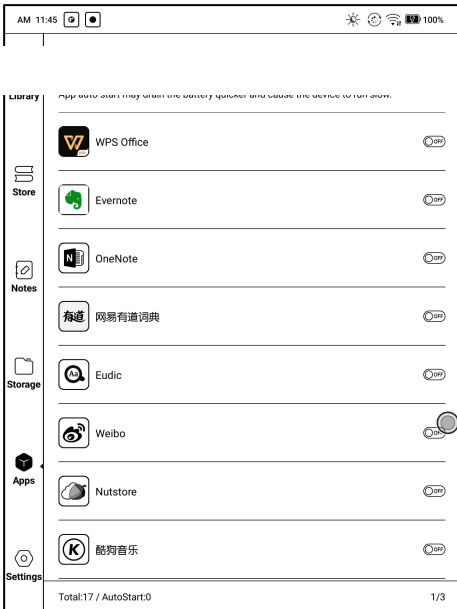

Refresh Mode Settings

This allows you to set the refresh modes of third-party apps in bulk.

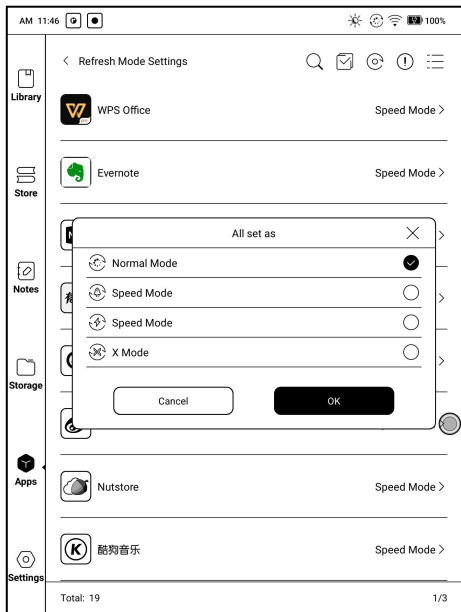

Freeze Settings

You can obtain the optimization settings of third-party apps with one click and freeze all apps in the background with one click for a better user experience and saving power.



Enable Google Play

If you want to use Google Play, you need to enable Google suite by the following steps:

1. Connect to internet. Go to Apps, drop down the menu on upper right corner, select Application Management > Enable Google Play

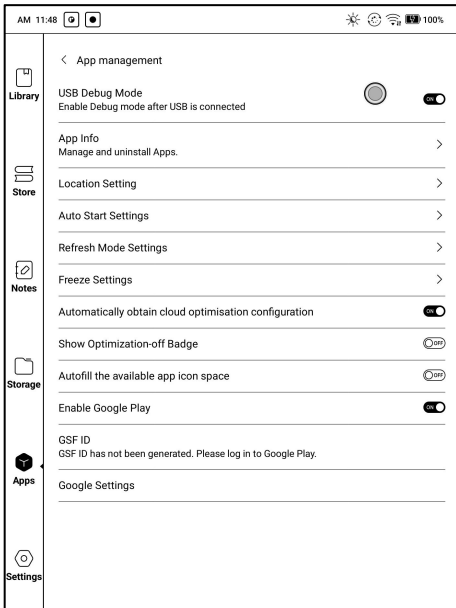

2. Tap “OK” when asked “Do you want to go to the activation page to enable Google Play?” .Then log in your Google account. A note will pop up saying “This device is not verified by Google” .

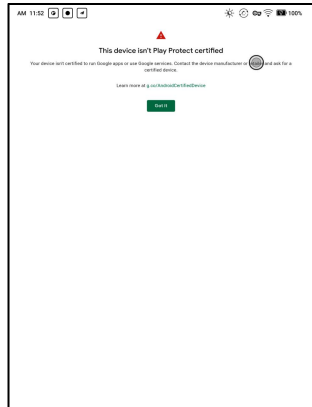
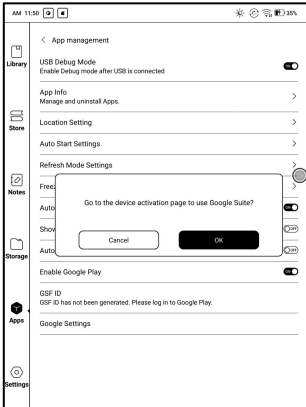

3. Go back to App Management page and tap GSF ID. You will go to GSF ID application page. Tick Human-machine Authentication and tap “Sign up” . (Google frame ID is automatically obtained and you do not need to enter.)

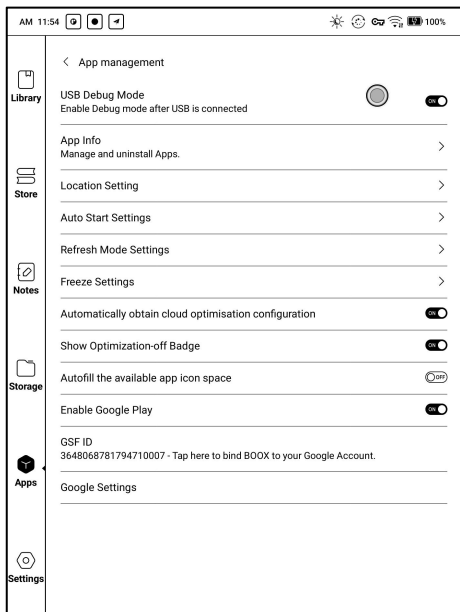

4. When you sign up successfully, there will be a note saying “The device has been registered”



5. When the device is connected to internet, Google Play will automatically download the latest version.

Please wait for 10–15 minutes for the Google server to return the verification result

(Due to different regions and network conditions, the actual length of time to pass the certification may vary)

6. Without restarting, open the Application Management > Google settings > log in to the Google account.

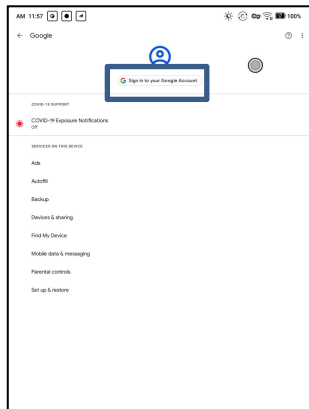
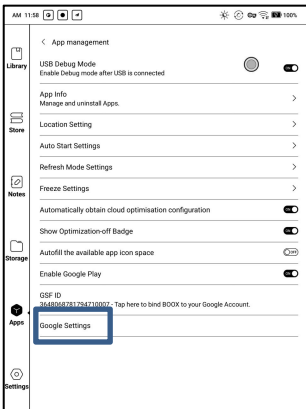

7. If it jumps to the login page here, it means it has been passed. You can restart the device after logging in to the account.

B. If it does not jump the protection mechanism page, it means it still hasn't passed. Please wait for a bit long and try again.

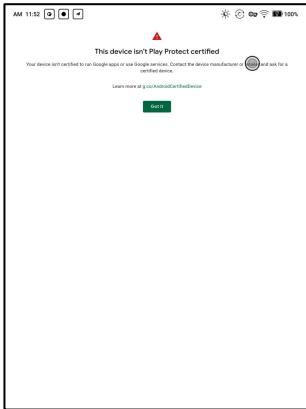

8. If you wait for too long and it still shows that the device is not verified by Google, it means the verification has not passed. Please start again from step 3.

App Optimization

Display

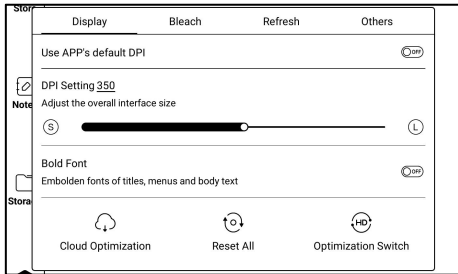

DPI: Adjust the interface size of the app. The default value is 350,

If some content of the app interface has been cropped, you can reduce the DPI value.

If the overall interface size of the app is too small, you can increase the DPI value.

If you've adjusted the DPI value to the minimum, some content of some app interfaces such as Kobo is still cropped, you can choose to use the app's default DPI.

Bold Font: Embolden fonts of titles, menus and body text.

Cloud Optimization: Some apps are specifically optimized and you can retrieve the cloud optimization configuration to obtain better results than local optimization;

Reset All: Reset all modified configurations to the original configurations.

Optimization Switch: when it is turned off, some optimization effects will be canceled, but it won't reset the configurations.

Bleach

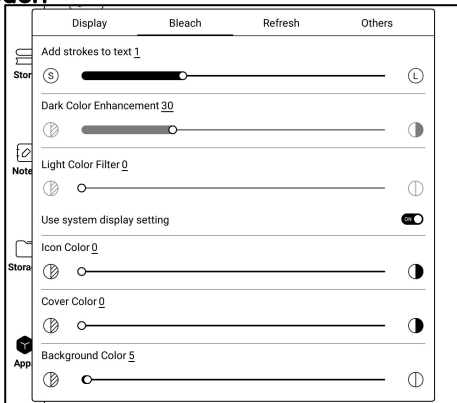

Add strokes to text: The text and background on the same layer will not be visible after being bleached together. This setting will add strokes to text and make the text visible.

Icon Color: this darkens the colors of small color icons in the Menu.

Cover Color: This darkens the colors of big cover icons.

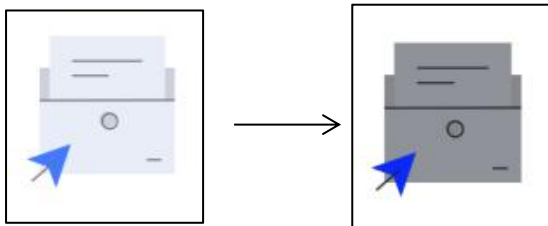

Background Color: This bleaches the background colors.

It is recommended to use it along with Font Color Enhancement and Icon Color. Otherwise, the text and small icons on the background may be hardly seen.

Refresh

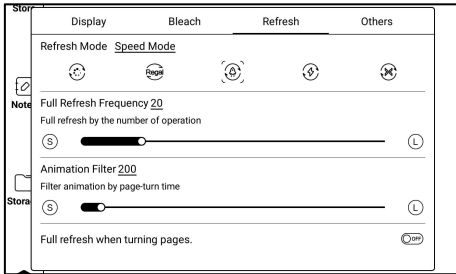

Refresh Mode: This sets the refresh mode for individual apps. Normally the default refresh mode is Speed Mode.

Only when system's refresh mode is Normal Mode, the app's refresh mode will take effect.

When system's refresh mode is set to Speed\A2\X Mode, the system mode has priority. And the app's refresh mode will not take effect.

Full Refresh Frequency: In app, fully refresh the screen by the number of tapping in order to reduce ghosting.

The actual number of taps is related to the app's configuration. Sometimes a single tap may have several consecutive responses. E.g, you've set 20 times, but full refresh may be initiated after 15 taps.

Animation Filter: Filter the animation of turning pages in the app. Time indicates the duration of the animation effect to be filtered. Generally, the page animation is about 200 ms;

Others

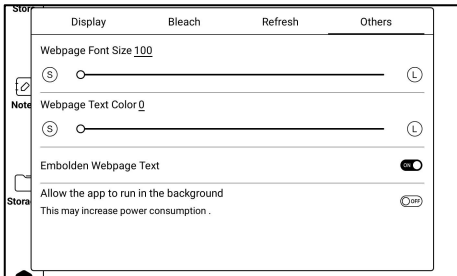

Full refresh when turning pages. : When the main function bar in the app is switched, full refresh is performed to reduce ghosting;

Switching some app function bar does not actually switch the pages, so full refresh would not be performed.

Webpage Font Size: Adjust the font size of the web view embedded in the app. When adjusting DPI does not work, try to adjust the font size of the webpage;

Webpage Text Color: When the adjustment of the bleaching does not work, you can try to adjust the color of the webpage;

Embolden Webpage Text: When Bold Font under Display tab does not work, try to embolden the text on the webpage;

Allow the app to run in the background:

For apps that need to run continuously in the background, such as Alarms, Notifications, Downloads, Time statistics and other apps, you can allow them to run in the background. But the continuous running in the background may increase power consumption!

Scribble

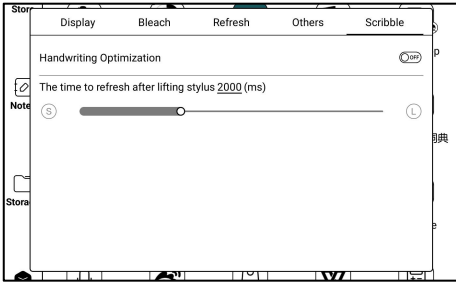

Only optimize handwriting speed for apps with handwriting function. Currently, it supports OneNote, Evernote, WPS. More handwriting apps support will be added in the future;

The time to refresh after lifting stylus: Handwriting will be refreshed to app's original brush configuration (including brush type, line width, pressure sensitivity, etc.) within the specified time after the pen is lifted;

When refreshing the handwriting, you cannot continue writing, please continue to write after refreshing is complete;

If you need to write continuously to reduce the interruption caused by refresh, you can set the longer refresh time;

Hand touch may interfere with the writing of the stylus. It is recommended to enable Palm Rejection to avoid canvas moving or zooming resulting in interruption of handwriting or abnormal display.

Navigation Ball

Navigation Ball is a circular ball that floats above all the apps on the screen. 9 buttons can be customized.

Single click on the ball to expand and collapse navigation menu.

It requires to turn off and on again after the new button settings.

The Navigation Ball by fault is in Fan-shaped style. You can choose other display styles (Horizontal Style, Vertical Style) from Navigation Setting.

You can also adjust the transparency of the Navigation Ball.

This supports to set as a resident button. After being set as a resident button, the button will always be floating on the top layer;

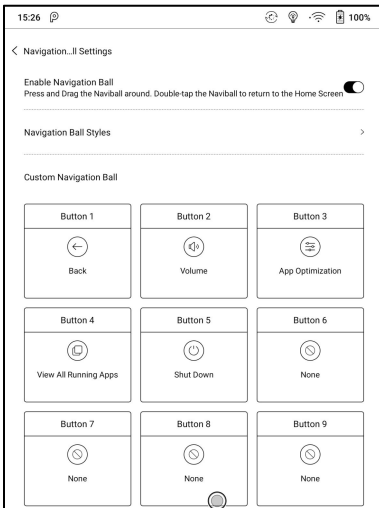

The 9 buttons can be set as multiple common functions including system operation, app switching, app optimization and so on.

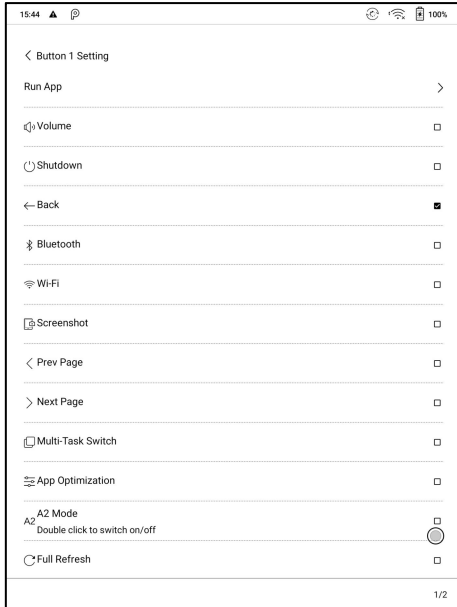

The app optimization can be called out in an app through the Navigation Ball, for real-time review after optimization.

Dictionary

If users use dictionary apps the first time, to download dictionary package to local will be asked.

This function requires network connection.

Word pronunciation needs a dictionary file comes with voice files, currently TTS is not supported.

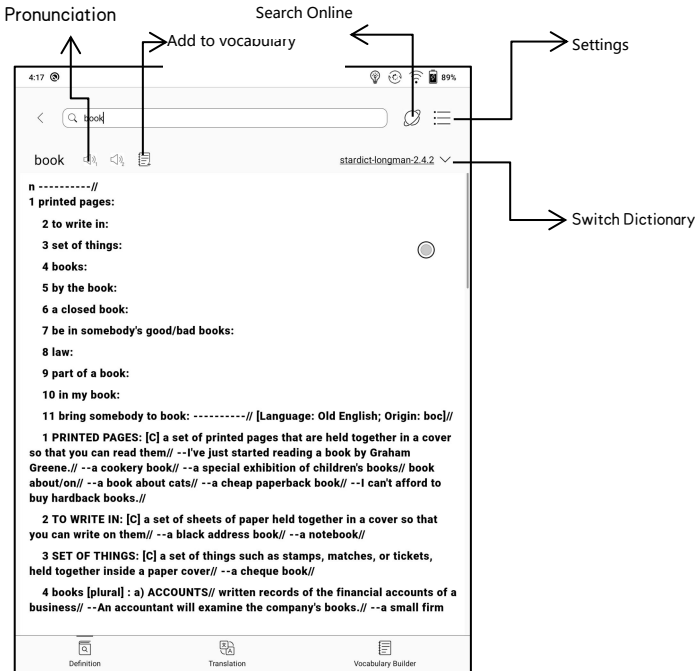

Users can install dictionaries themselves by putting the dictionary files to designated directory Storage\dicts\.

Please save the files under a folder, e.g., dicts\English-English Dictionary.



For the preferred dictionary settings, users can select up to 20 preferred dictionaries. Users will be asked to select again if the select number is

less than 1 or more than 20.

After dictionaries are installed, users can look up new words in the search bar. Switch between different dictionaries by tapping a corresponding dictionary title on the bottom.

The search result is in terms of the related dictionary. If the word is unfound, try to use other dictionaries.

Looked-up words can be added to Vocabulary.

Users can divide the Vocabulary into groups. The words will be saved into the specified group once the group is selected.

BOOXDrop

Connect your BOOX with PC or mobile phone. You can send files to your BOOX from PC or BOOX Assistant app, or save files on your BOOX to PC or mobile phone.

Instruction:

1. Open BooxDrop from Apps page or drop-down Control Panel

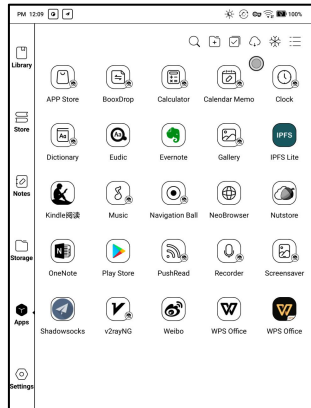
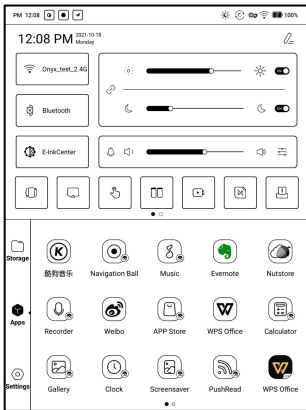

2. Open a browser APP on your PC

2.1 Without login: Make sure your BOOX and PC are in the same network.

Enter the IP address on your BOOX to the browser on your PC.

BooxDrop does not disconnect automatically. If you want to disconnect it, please do it manually or switch it off from Control Panel.



2.2 Logged in to ONYX Account: log in to push.boox.com. You can see the connected devices on Push page. Click it to open.

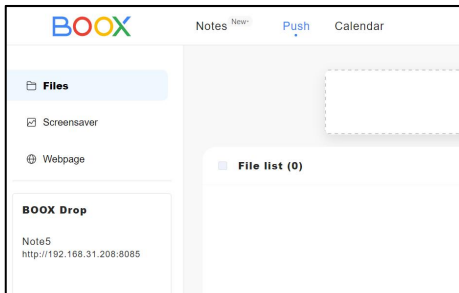

3. When you open the web browser on your PC, it will automatically confirm whether your PC and BOOX are in the same Wi-Fi network. If not, the page cannot be opened. Please connect to the same Wi-Fi.

4. When web end and your BOOX are connected successfully, you can load files and contents from your BOOX on your PC.

5. Send to BOOX: Select files from your PC and send to BOOX.

The sent files are automatically classified into the corresponding directory according to the format types.

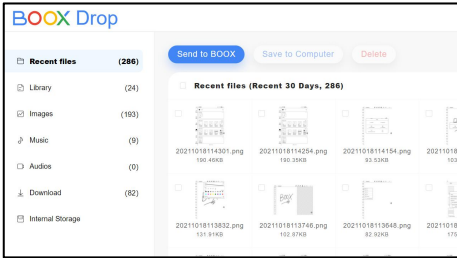

Recent Files: include all files and are sorted by time

Library: Books/xxx.epub (This includes all supported eBook formats in the Library)

Pictures: Pictures/xxx.png

Music: Music/xxxx.mp3

Videos: Movies/xxxx.mp4

Downloads: Download/xxx.xxx

Internal Storage: Transfer the selected directories.

6. Save to Computer: Select the files on BOOX and save them to computer.

Records

You can only check the transfer history on BOOX devices.

PushRead

From the Subscription section of push.boox.com or BOOX Assistant, you can enter a webpage address, push it to your BOOX, and read the page in html format.

To use the PushRead for the first time, you need to bind the same ONYX account on the website push.boox.com and your BOOX;

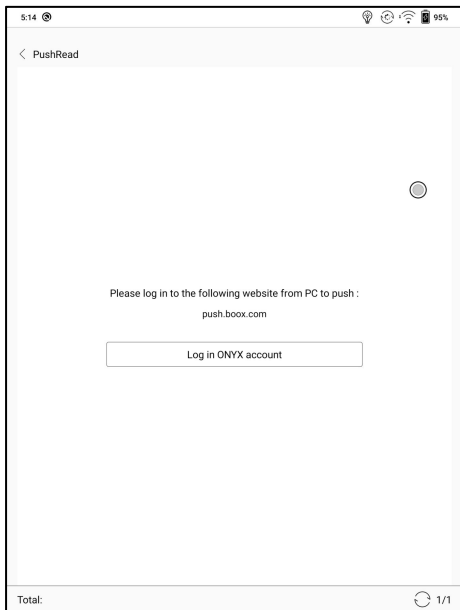

You need to connect your BOOX with Wi-Fi to download the pushed URLs for the first time. After loading once, it can be read offline later;

The layout of the content page defaults to Browsing Mode (the layout of the original web page), and you can choose to switch between Browsing Mode and Reading Mode from the More Menu;

The Reading Mode is a single page mode, tap the page to turn the page directly;

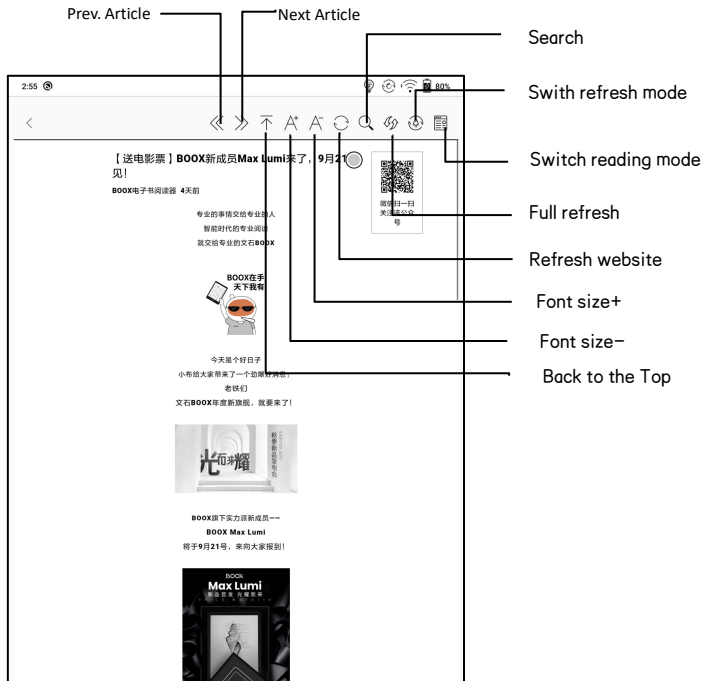

App Store (E-ink)

There are some usual third-party apps provided here. These apps are free versions from developers and their compatibility are not verified as full to the system. Paid apps download is not supported for now.

Users can choose to delete the installation package automatically after Apps are installed.

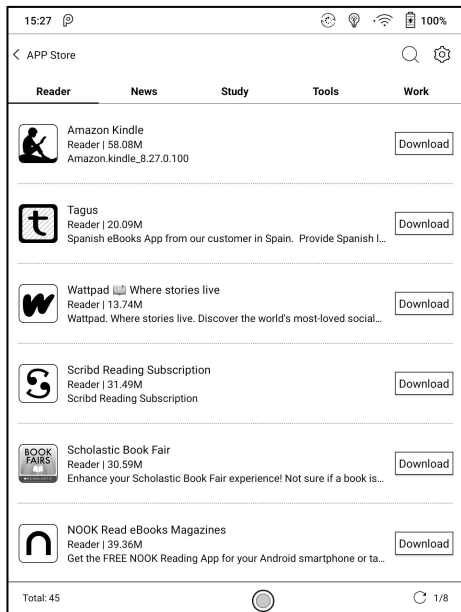

Screensaver

The screensaver and shutdown image can be customizable. The shutdown image only supports image formats.

Screensaver style

The Image Screensaver is by default.

The screensaver supports Image Screensaver, Poem Screensaver, Words Screensaver, Calendar Screensaver, Clock Screensaver, and Transparent Screensaver.

The clock, text, and Bottom Status Bar can be added to the other screensavers aside from the Transparent Screensaver.

Clock refresh intervals are customizable. After the clock is added to a screensaver, a certain frequency of refreshing screen will be retained in the standby state, and the automatic shutdown timing cannot be supported.



In Image Screensaver, when a single picture is selected, the screensaver is a fixed picture. When multiple pictures are selected, the screensaver will be shown in carousel format;

The Bottom Status Bar can display the battery status and lock screen status;

Calendar Memo

The calendar Memo can display the notes and reading records under the current date. You can open the notes or documents directly by tapping the records;

You can add handwritten notes as a memo, which can be set as a screensaver. Please go to Screensaver / Calendar Screensaver Setting for more details.

The content of Calendar Memo temporarily does not support the synchronization.

The screenshot displays the Calendar Memo application. At the top, there is a navigation bar with a back arrow, the text "< 2021-3 >", and icons for mail, calendar, and a list. Below this is a calendar grid for the month of March 2021. The date March 5th is highlighted in black. At the bottom of the screen, there are two panels. The left panel, titled "Today's Notes" and "Today's Reading", shows a note from "Notepad1" dated "Mar 5, 2021 3:55:58 PM". The right panel, titled "Memo", contains a handwritten note that says "BOOK".

Sun	Mon	Tue	Wed	Thu	Fri	Sat
28	1	2	3	4	5	6
7	8	9	10	11	12	13
14	15	16	17	18	19	20
21	22	23	24	25	26	27
28	29	30	31	1	2	3
4	5	6	7	8	9	10

Today's Notes Today's Reading

Notepad1
Mar 5, 2021 3:55:58 PM

1/1

Memo

BOOK

After logging in to the ONYX account, you can use the mail function to send the contents of the Memo to the designated mailbox as a PDF attachment;

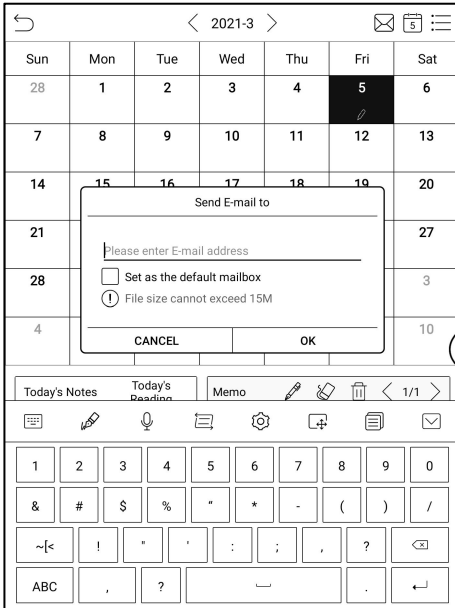

Split Screen

This supports Apps Split-Screen. You can select Split-Screen from the system drop-down bar when an application is opened, and then select a document, a notepad or other application that you want to open on the other side of your screen.

The system interface does not support enabling Split-Screen directly. You need to start an application before enabling it;

The applications that do not support Split-Screen will prompt "This application does not support Split-Screen" when split screen is enabled;

There are 2 modes available: Vertical and Horizontal. You can swap sides of the apps.

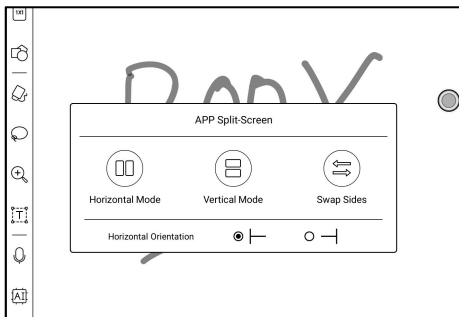

When in split-screen mode, the left screen (or the top screen) will be the main screen. And the secondly opened app will be on the right screen (or lower screen). You can swap apps' sides.

In Split-screen mode, exit Split-screen mode from the system drop-down menu.

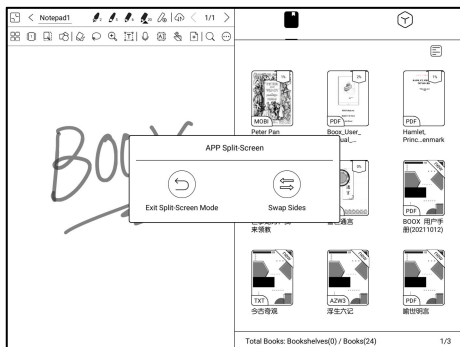

Only main screen supports Optimization>Refresh Settings. The refresh settings of the app on the secondary screen will not take effect.

The Optimization > Display settings of both apps on both screens are in effect.

11. Settings

You can manage ONYX accounts, check device model and manage system global settings.

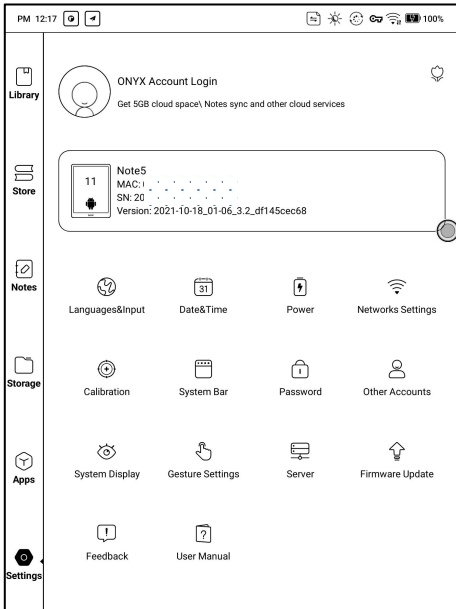

ONYX Account

You can manage multiple accounts and switch them. Select accounts from the list. Only account information is kept and login state is not maintained.

After switching to a different account, you need to log in again.

If you log in to different accounts with different servers, please change the server as well when switching accounts.

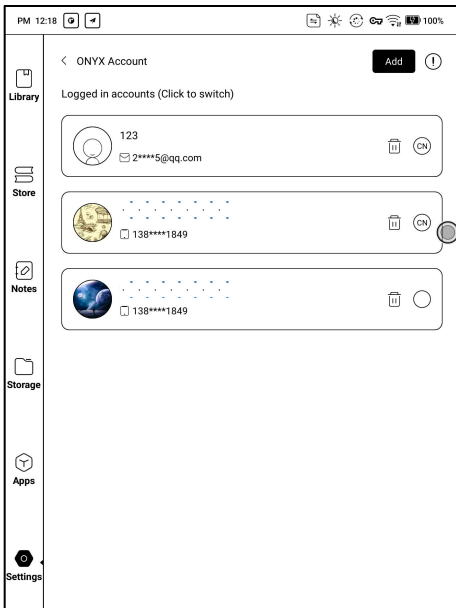

ONYX account included: BooxDrop, Reading Statistics, PushRead, Send to E-mail.
E-mail.

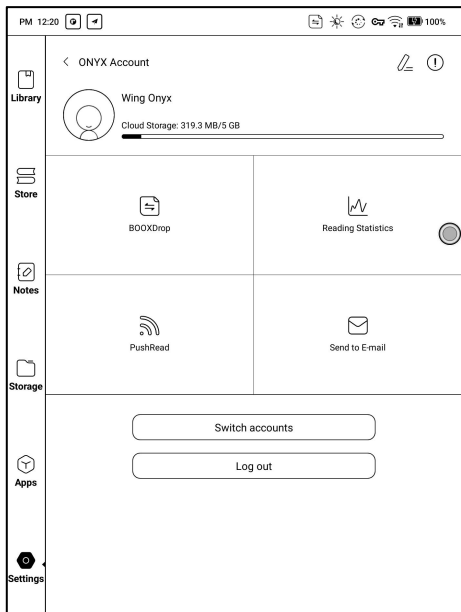

Account Link: After the main account is logged in, you can associate two other login methods sharing the same ONYX account. Mobile and E-mail accounts support unbinding, and WeChat accounts do not support unbinding.

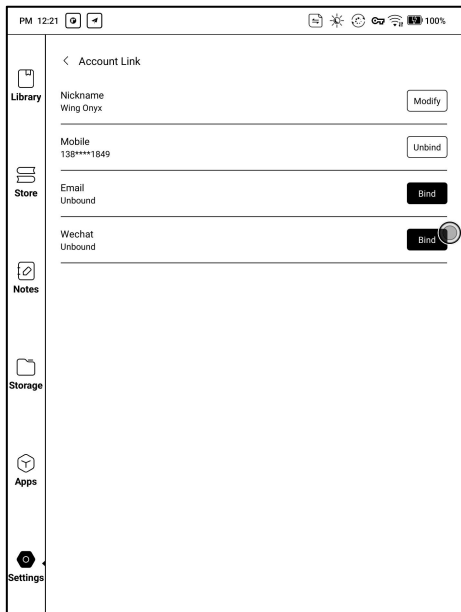

About Device

It contains model name, Android version, MAC address and firmware version.

Click the model number for more information, including Capacitive Touch Version, VCom, Other information, Factory Reset, etc.

Note: To run the function of factory reset would remove all of the user data. Please make a data backup first.

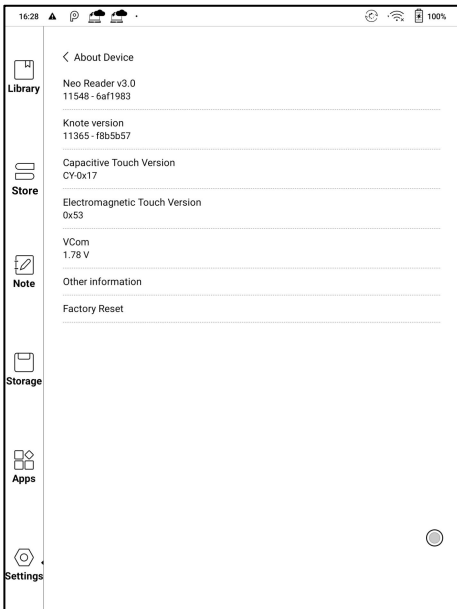

Languages & Input

Users can set system language, keyboard and input method and TTS on this page;

Users can set languages of the system and virtue keyboard. The system has an Android keyboard by default. Users can install third-party Apps for more input methods.

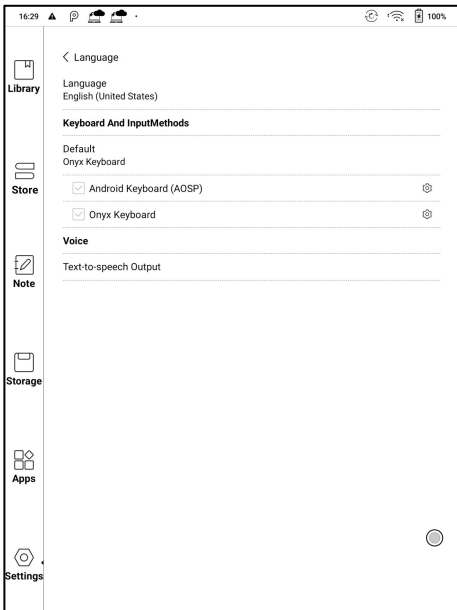

ONYX Keyboard

Typing, handwriting input and voice input are available for ONYX keyboard, and network connection is necessary for first time.

English is the default language of the handwriting input and users need to download the corresponding language package first if they want to use handwriting input for other languages.

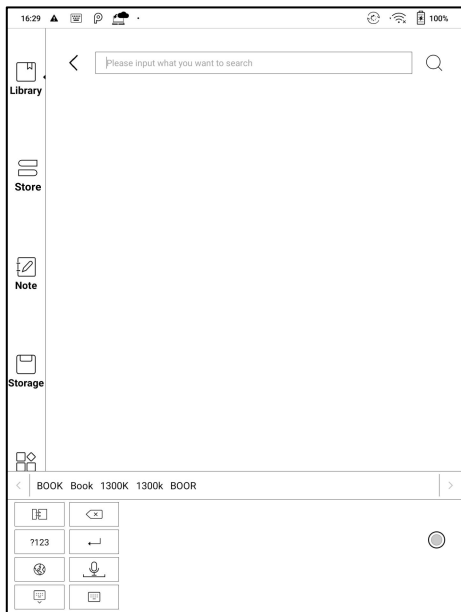

Handwriting Input Language Packages

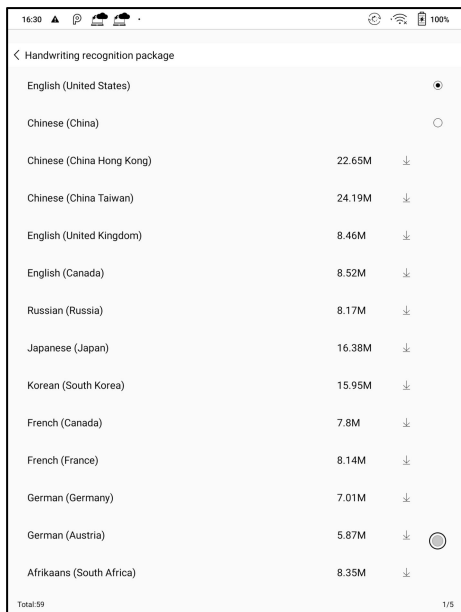

The screenshot shows the 'Handwriting recognition package' settings on an iOS device. The interface includes a status bar at the top with the time 16:30, signal strength, Wi-Fi, and battery icons. A back arrow is visible in the top left corner. The list of packages is as follows:

Language Package	Size	Download Status
English (United States)		Selected (radio button)
Chinese (China)		Not selected (radio button)
Chinese (China Hong Kong)	22.65M	Downloaded (down arrow)
Chinese (China Taiwan)	24.19M	Downloaded (down arrow)
English (United Kingdom)	8.46M	Downloaded (down arrow)
English (Canada)	8.52M	Downloaded (down arrow)
Russian (Russia)	8.17M	Downloaded (down arrow)
Japanese (Japan)	16.38M	Downloaded (down arrow)
Korean (South Korea)	15.95M	Downloaded (down arrow)
French (Canada)	7.8M	Downloaded (down arrow)
French (France)	8.14M	Downloaded (down arrow)
German (Germany)	7.01M	Downloaded (down arrow)
German (Austria)	5.87M	Downloaded (down arrow)
Afrikaans (South Africa)	8.35M	Downloaded (down arrow)

At the bottom left, it says 'Total: 59' and at the bottom right, it says '1/5'.

Voice Input

Long press the Space button on the ONYX keyboard to enable the voice input first. Only English, Mandarin, Cantonese, and Sichuanese are supported.

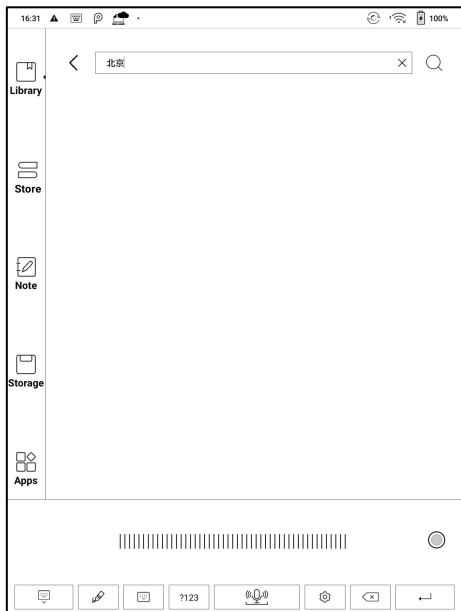

Date & Time

Users can choose either auto setting or manual setting for date and time. When the device is connected with internet, it will automatically set date and time according to local time zone. Manual setting requires to set time zone, date and time, and users can select their preferred time and date display format;

Power

Users can set screen auto sleep timeout, Power off timeout, Delay disconnection when the device goes to sleep mode, Battery usage 、 Battery percentage、 Auto-sleep when closing the cover, etc.

Network

This is for Wi-Fi \VPN\Bluetooth setting. When Wi-Fi is connected, users can browse webs and download books via the internet on the device.

Wi-Fi Settings

Slide Wi-Fi On, then available networks will be listed. Users can choose a network, then input password to connect with internet.

After Wi-Fi is connected successfully at the first time, the device will save Wi-Fi information automatically. Users only need to turn on Wi-Fi on notification bar if using the same WIFI next time.

Click the “+” button at the top right of the Wi-Fi page, users could manually connect to other network which is not listed, such as 802.1xEAP.

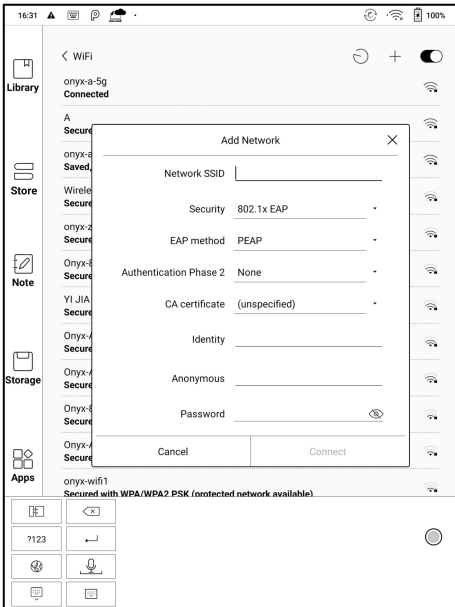

Bluetooth Settings

Turn on Bluetooth, you can search for nearby Bluetooth devices and then send connection requests.

Bluetooth needs to be paired before use. Currently only support the eReader to receive documents, send documents from Boox eReader to other devices is not supported.

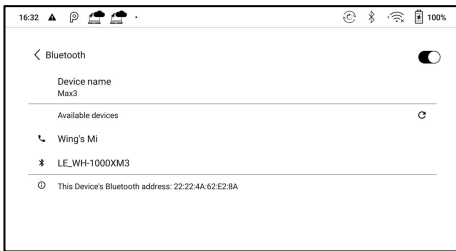

VPN Setting

- When the VPN is turned on for the first time, the system requires to set a password. This password needs to be used only for screen unlock or when the factory settings are restored.

System Bar

You can customize the pull-down menu. Pull-down menu from left and right sides are different.. The left pull-down is the Notification Center, and the right pull-down is the Control Panel;

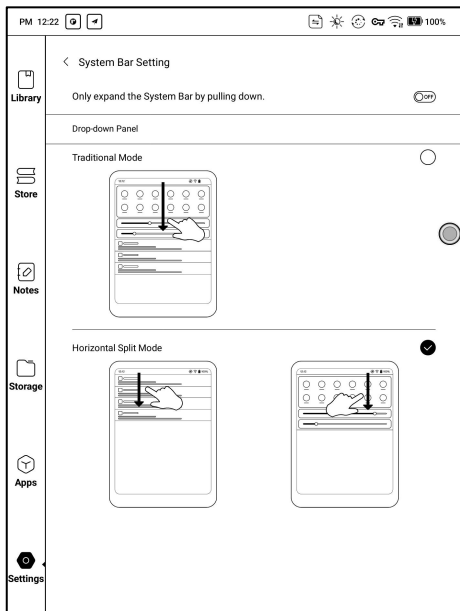

Other accounts

You can manage other accounts including Google, DropBox, OneNote, etc.

These accounts are only used for syncing notes.

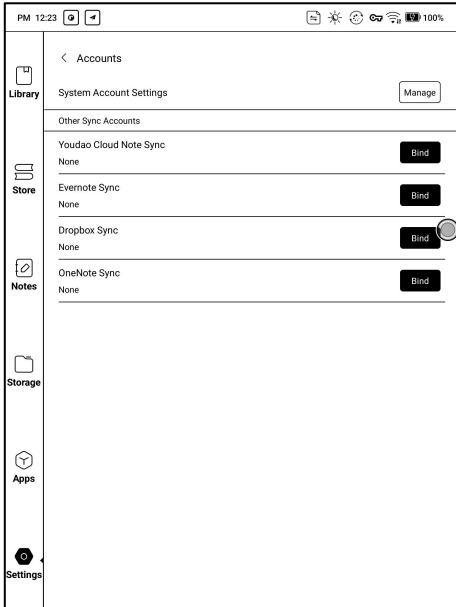

Password

You can set 4–16 digital screen–lock password.

The Android 11 models do not support resetting the password, please keep the password properly by yourself.

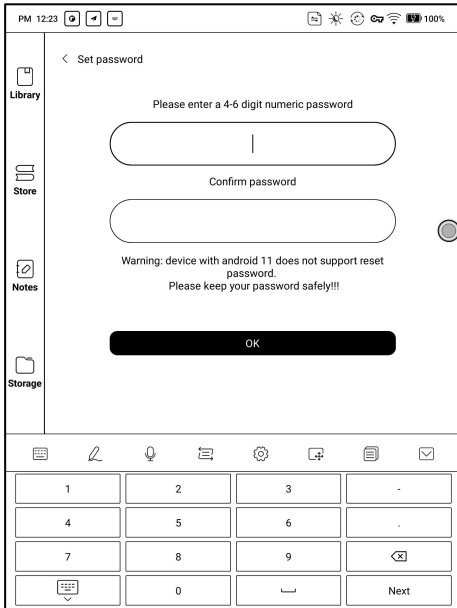

System Display

System Font size

Support to adjust the system font size, the default is the standard font

size, you can set a total of 4 sizes: small, standard, large, extra-large;

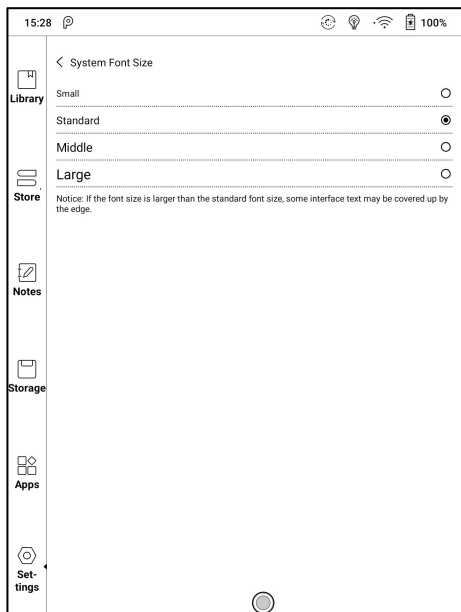

Custom Homepage

The default Homepage is Library. You can set any of the other Function pages as the Homepage. You can return to the Homepage by tapping the homepage icon from the dropdown notification center.

System full screen refresh frequency

The system performs one full refresh every 5 operations

The Library and Notes will be automatically refreshed once more due to the loading list, and the actual number of operations will be one less than the set number;

Function Area display icons only

The text under the Function icon can be hidden.

Enable Book Store

The built-in book store can be turned off, but cannot be uninstalled or removed.

Gesture Manager

You can customize 3 gestures for the bottom and 2 gestures for the sides.

The default functions for the Bottom include: Back, Back Home, Multitasking Switching...etc. Swipe up from the bottom to use them.

The default functions for the sides are Volume +/-, and Frontlight +/-.

Long press the sides to slide up and down to adjust.

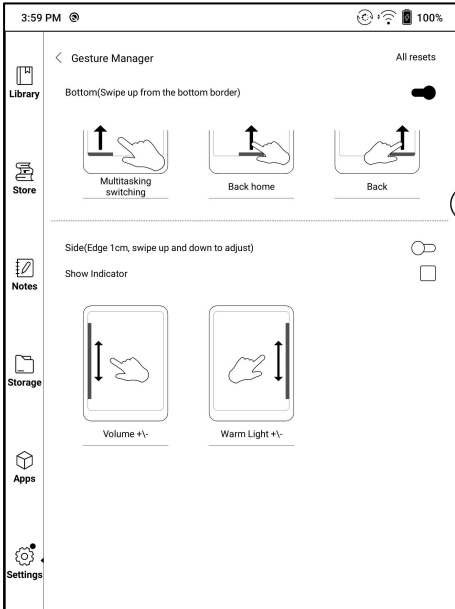

Support modification to other functions;

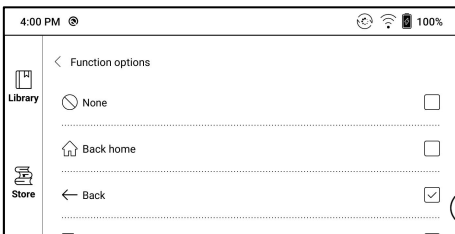

Server

The server is allocated according to the system language by default. The Chinese language system uses the Asia server, and the other language systems use US server;

After manually selecting the server, it will no longer be automatically matched according to the system language;

Please choose the server in your area. This will avoid the slow network connection which impacts the use of some specific functions (including bookstore, synchronization, application market, OTA detection and other functions that require networking);

Firmware Update

Users can get the Model number, Android version, Build number and update check. Upgrade checks the local package first then online package with a network connection. Upgrade pause and breakpoint download are allowed. Please ensure the device has more than 30% power and sufficient capacity before the update.

Update History

Check Update History and the changelog of every update.

Feedback

FAQ

If having any problems, you can directly find the questions in the FAQ, quickly locate and solve the problems.

Submit Feedback

Welcome to submit any technical problem or advice to us.

This function collects system information for problem judgment. And Onyx shall never disclose users' device information.

The related logs will be cleared after the device shuts down. If you need to send feedback after the device is off, please enable Save Logs to local in Feedback so that you can send related logs after restarting the device.

12. Specifications

	NoteAir2
Processor	2.0GHz*4 + 1.8GHz*4
RAM	3G LPDDR4X
OS	Android 11
Storage	32G
Screen	E-ink display with Regal refresh
Screen Size	10.3 inch
Resolution	1404*1872
Touch	Stylus + Capacitive touch
Front Light	Support
Wireless	WIFI (2.4G+5G) + Bluetooth (5.0)
Battery	3000 mAh
USB	Type-C (support USB OTG)
Others	Mic, Dual Speaker
Size	229.4X195.4X5.8mm
Weight	≤420 g (battery included)
Operating Temperature	0° C– 50° C
Book Formats	PDF, EPUB , TXT, DJVU, HTML, FB2, DOC, MOBI, CHM, etc.
Image Formats	PNG, JPG, BMP
Audio Formats	WAV , MP3
Apps	Third party APP installation is supported
Browser	Support
Language	Multi-language supported

Firmware Update	Locally update and OTA update are available
Certification	CE、RoHS、CCC、FCC、SRRC、TELEC

13. Declaration

Onyx International Inc. reserves the right to modify the content of the Quick Start Guide and User Manual without further notice.

For more information, please visit our website at www.boox.com.