

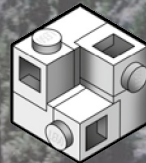

CREATOR™



EXPERT

10271



Booklet available in English on
Heft in deutscher Sprache erhältlich auf
Livret disponible en français sur
Folleto disponible en español en
如需中文版手册，请访问

LEGO.com/service/buildinginstructions



The Heritage

Il retaggio

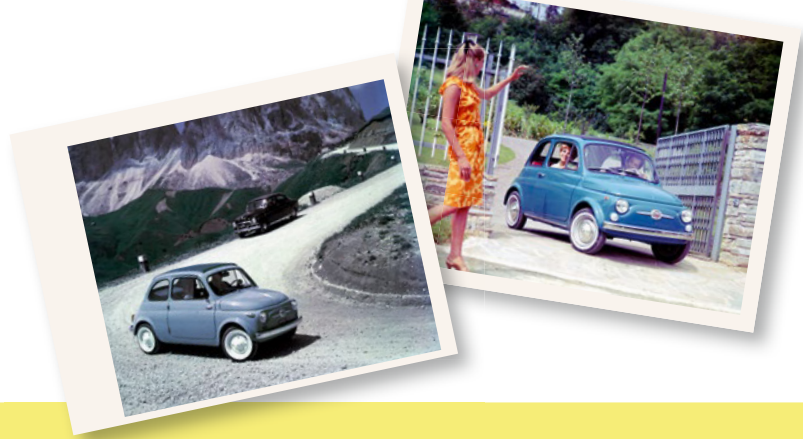

1899



1901



1904



1921



1925



1929



1931



1965



1931



1932



1938



1959



1968



1991



1999



2006



Vintage brochures for the Fiat 500

Brochure vintage per la Fiat 500





It all began in July 1899 when the Fabbrica Italiana Automobili Torino was founded as Italy's first automotive company. By 1900, 24 Fiat 3½ HP cars had rolled off the assembly line, built by a workforce of just 150 people. Soon Fiat would be producing everything from railway engines to farm tractors, but the company's central passion would always be the automobile. Throughout its 120-year history, Fiat has always played a visionary role in the continued evolution of what the company's founders called "democratic mobility".

Tutto ebbe inizio nel luglio 1899, quando venne fondata la Fabbrica Italiana Automobili Torino, la prima casa automobilistica italiana. Nel 1900, 24 Fiat 3½ HP uscirono dalla catena di montaggio costruite da una forza lavoro di appena 150 persone. Presto, la Fiat avrebbe cominciato a produrre di tutto - dai motori ferroviari ai trattori agricoli - ma la prima passione dell'azienda sarebbe sempre rimasta l'automobile. Nel corso dei suoi 120 anni di storia, la Fiat ha sempre avuto un ruolo visionario nella continua evoluzione di quella che i fondatori dell'azienda chiamano "mobilità democratica".



1936-1955
FIAT 500 Topolino



1957-1960
FIAT Nuova 500



1960-1969
FIAT 500 D



1960-1977
FIAT 500 K/Giardiniera



The Fiat 500

La Fiat 500

1965-1972
FIAT 500 F



1968-1972
FIAT 500 L/Lusso



1972-1975
FIAT 500 R/Rinnovata



2007-2015
FIAT 500



2009-2015
FIAT 500 C

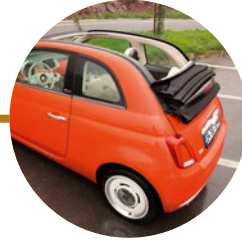

2015 - present
FIAT 500

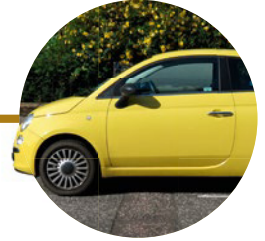

Launched in 1957, the iconic 500 (pronounced Cinquecento in Italian) was the company's response to the need for a car that was both economical and practical. The two door, four-seat saloon was an inexpensive, compact vehicle measuring only 2.97 m (9 ft. 9 in.) in length and powered by a 479 cc two-cylindered, rear-mounted air-cooled engine. The true ingenuity of the design lay in overcoming the technological challenge of reducing the size of each component, while still maintaining the 500's youthful, timeless spirit.

Lanciata nel 1957, l'inconfondibile 500 fu la risposta dell'azienda alla domanda per un'auto economica e pratica. La berlina a due porte e quattro posti era un veicolo economico e compatto di soli 2,97 m di lunghezza e spinta da un motore a due cilindri da 479 cc, montato posteriormente e raffreddato ad aria. L'ingegnoso design consentì di vincere un'importante sfida tecnologica: ridurre le dimensioni di ogni componente pur mantenendo lo spirito giovanile e senza tempo della 500.





LA DOLCE VITA





In many ways the launch of the Fiat 500 captured the spirit of the time, especially in a mid 1950s Italy that was enjoying an economic boom and a cultural renaissance. The 500 quickly became an icon for a generation that was determined to savour what became known as “the good life” (La Dolce Vita).

Per molti versi, il lancio della Fiat 500 catturò lo spirito dell'epoca, soprattutto in un'Italia che, a metà degli anni '50, stava vivendo un boom economico e una vera rinascita culturale. La 500 divenne ben presto un'icona per una generazione determinata ad assaporare quella che in seguito divenne nota come “la dolce vita”.



The Challenge

La sfida

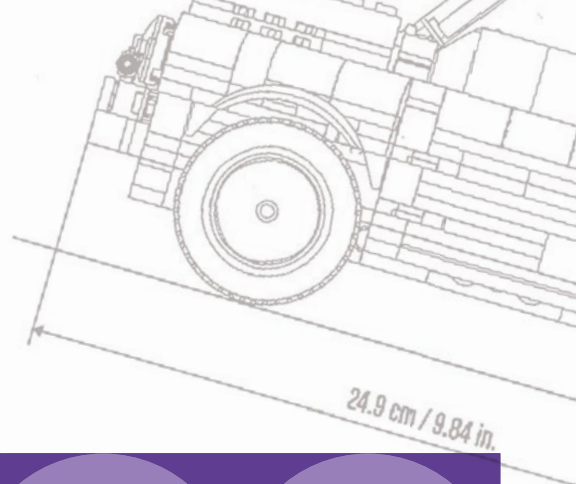

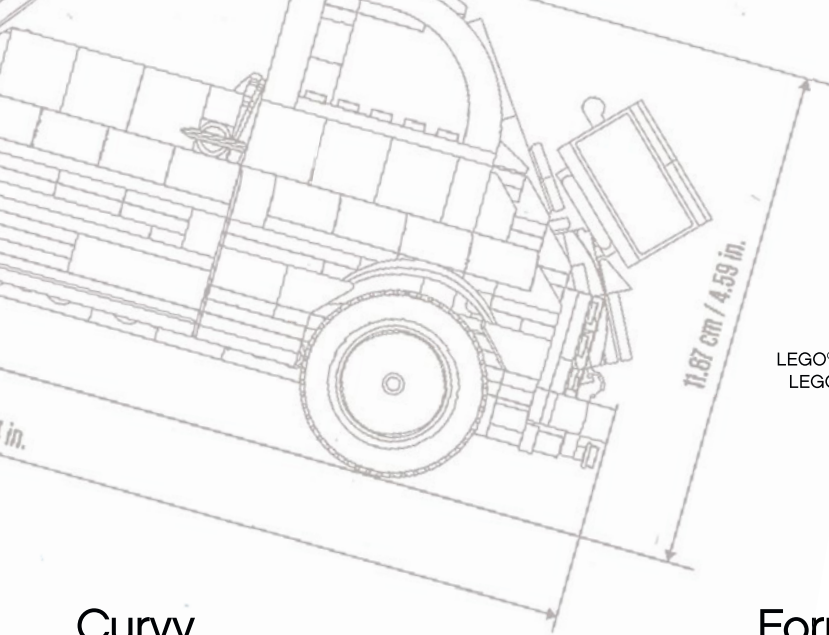

Pierre Normandin

LEGO® Senior Designer
LEGO Creator Expert



Curvy

“Capturing the compact size and the curvy shapes were probably the biggest challenges I faced creating this model. It changed every day until we thought we had something as close as possible to what we wanted it to look like. I’m quite satisfied with the car overall, but the interior details, the back hatch and the doors are amongst my favourite parts. We took an early version of the model to Turin, Italy. It was great to get feedback directly from the designers at Fiat and see how passionate they are about the 500 and its legacy.”

Colourful

“Even though it was never an official colour for the Fiat 500, we decided to go for this cool yellow tone for a few reasons, the main one being to get a vibrant colour that suited the “dolce vita” feeling that the 500 is often associated with. On top of that, it’s a relatively uncommon LEGO® colour as well, so we knew our own fans would appreciate getting more LEGO elements in this rare colour.”

Forme sinuose

“Catturare le dimensioni compatte e le forme sinuose è stata probabilmente la sfida più grande che ho dovuto affrontare per creare questo modello. È cambiato ogni giorno, finché non siamo riusciti a ottenere un design abbastanza fedele e che rispecchiava le nostre intenzioni originarie. Sono abbastanza soddisfatto della vettura nel suo complesso, ma i dettagli interni, il cofano posteriore e gli sportelli sono tra le mie parti preferite. Abbiamo portato una prima versione del modello a Torino, in Italia. È stato fantastico ricevere del feedback direttamente dai designer della Fiat e vedere quanto siano appassionati della 500 e del suo retaggio”.

Colorata

“Anche se non è mai stato un colore ufficiale della Fiat 500, abbiamo deciso di scegliere questa tonalità di giallo per diversi motivi, ma soprattutto perché questo colore vibrante riflette il concetto di “dolce vita” a cui la 500 è spesso associata. Inoltre, è anche un colore LEGO® relativamente raro, quindi sapevamo che i nostri fan avrebbero apprezzato avere più elementi LEGO di questa tonalità”.





CREATOR™

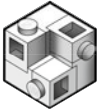

EXPERT

It's the smallest details that make the biggest difference in a LEGO® Creator Expert model, so this Fiat 500 F model is packed with authentic functions and features that aim to capture the spirit of the original iconic vehicle.

Sono i dettagli più piccoli che fanno la differenza in un modello LEGO® Creator Expert, quindi questa replica della Fiat 500 F è ricca di funzioni e caratteristiche autentiche che mirano a catturare lo spirito del veicolo originale.





500

The original 500 series was produced from 1957 to 1975 and despite its small size proved an enormously popular vehicle. Fifty years after the first 500 was presented, Fiat launched an all-new, retro-styled 500 to take the icon into a new era.

La serie della Fiat 500 originale fu prodotta dal 1957 al 1975 e, nonostante le sue piccole dimensioni, si rivelò un veicolo estremamente popolare. Cinquant'anni dopo l'introduzione della prima 500, la Fiat ha lanciato una nuova 500 in stile retrò per trasportare l'icona in una nuova era.



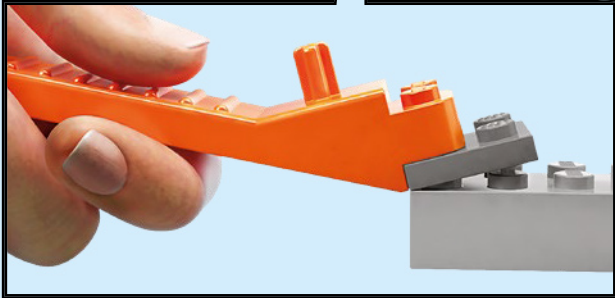
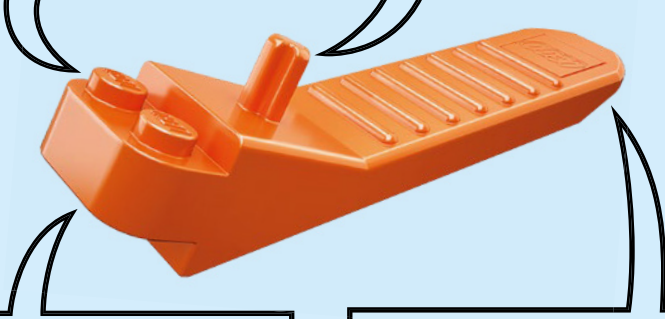
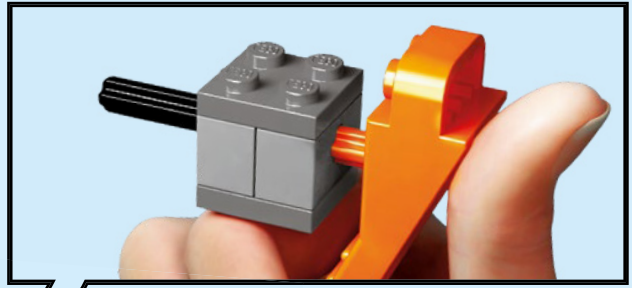
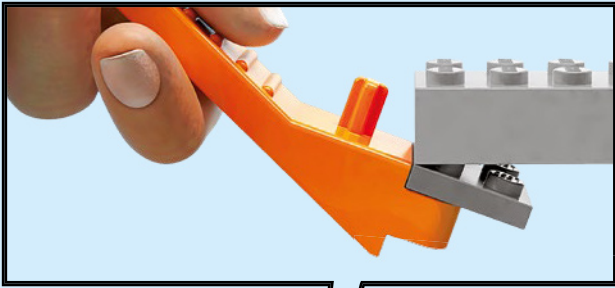



- 1** Scan the code on the front cover
 Scanne den Code auf der Titelseite
 Scanne le code sur la page de couverture
 Scanner le code sur la page couverture
 Scansiona il codice sulla copertina
 Escanea el código de la portada
 Faz scan do código na frente da capa
 Olvasd be a borítón látható kódot!
 Noskenē kodu uz priekšējā vāka
 扫描封面上的二维码



- 2** Get the Building Instructions
 Hol dir die Bauanleitung
 Hol dir die Bauanleitung
 Obtens les instructions de montage
 Obtenir les instructions de montage
 Scarica le istruzioni per la costruzione
 Consulta las instrucciones de construcción
 Obtém as Instruções de Construção
 Szerezd be az építési útmutatókat!
 Saņem būvēšanas instrukcijas
 获取拼搭说明

LEGO.com/apps

Check for compatibility
 Kompatibilität prüfen
 Vérifier la compatibilité
 Controlla la compatibilità
 Comprueba tu compatibilidad

Verificar a compatibilidade
 Ellenőrizd a kompatibilitást
 Pārbaudīt saderību
 检查兼容性

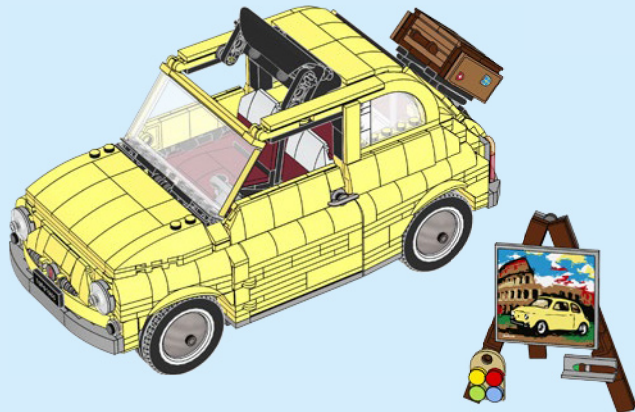
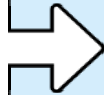
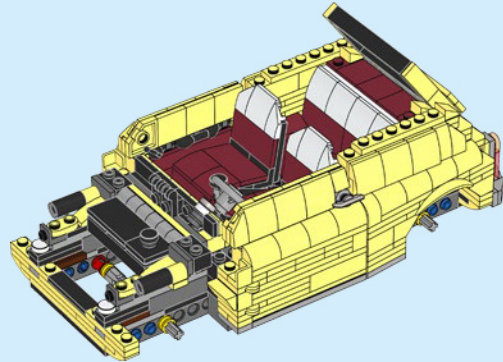
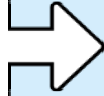
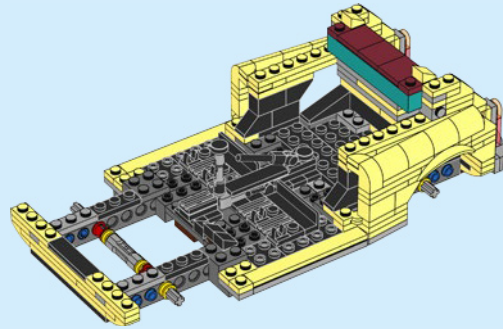
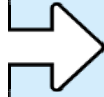

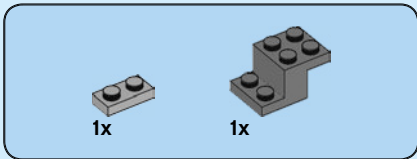
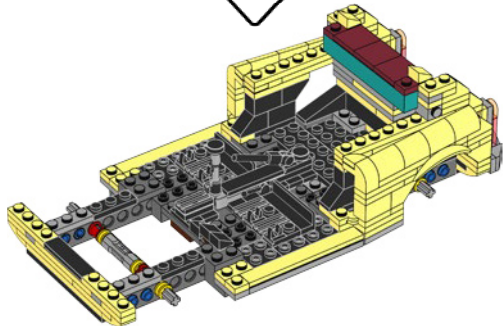
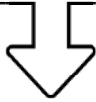

1

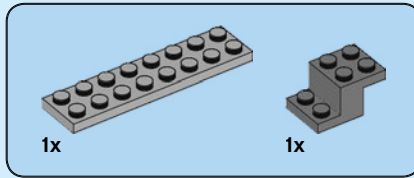
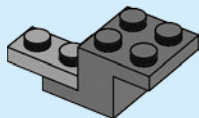

2

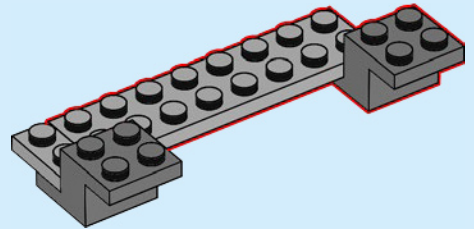

3

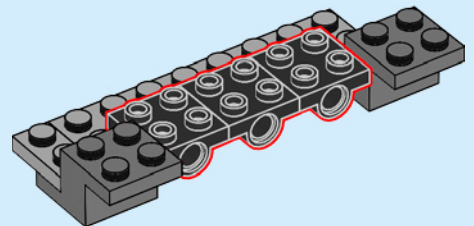

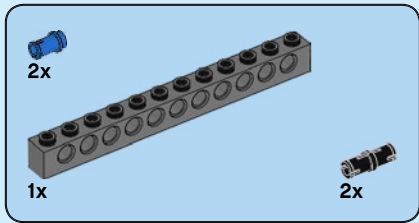

4

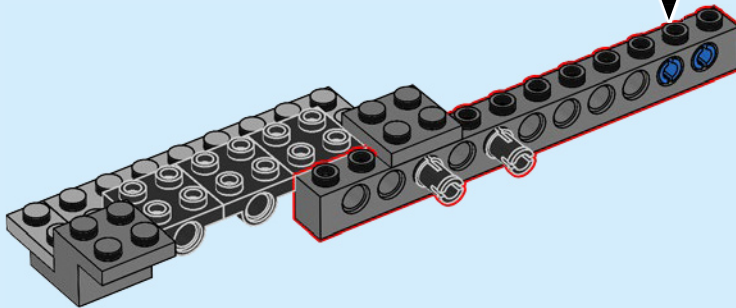
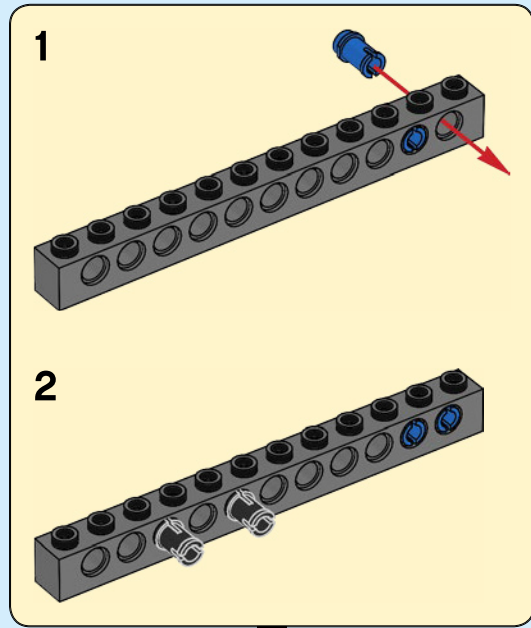

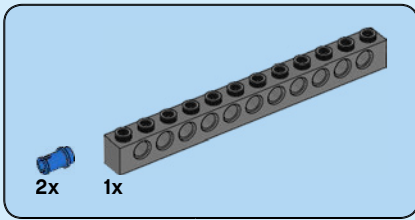

5

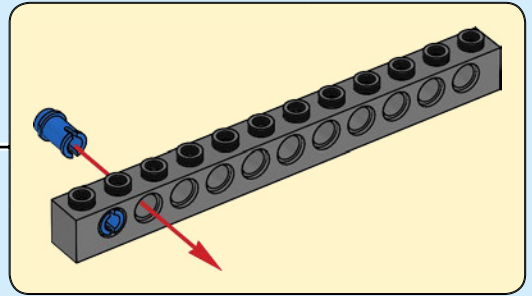
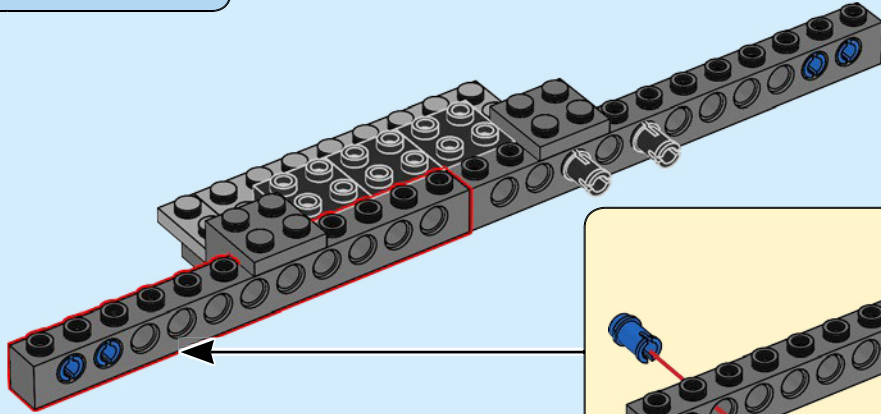

6

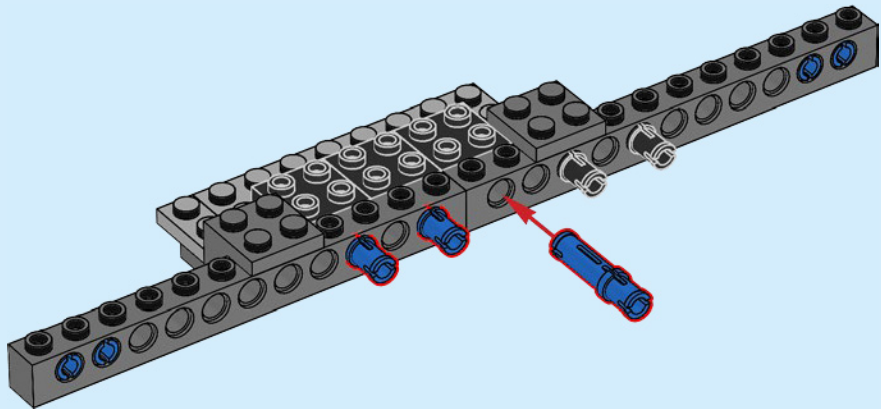

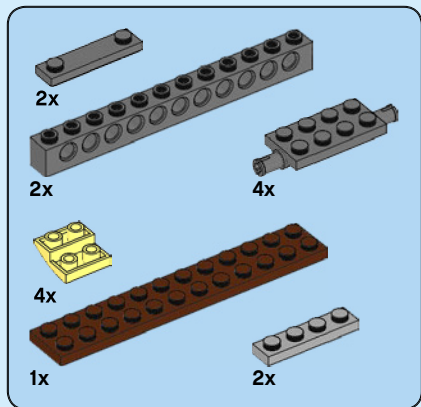

7

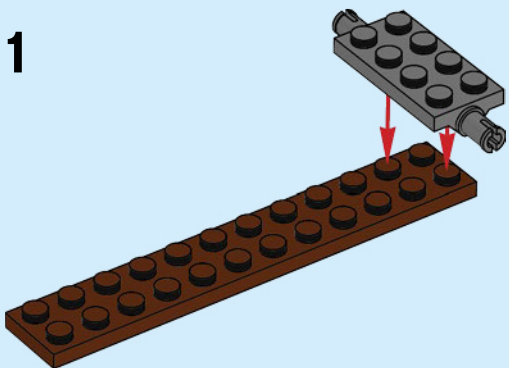

2

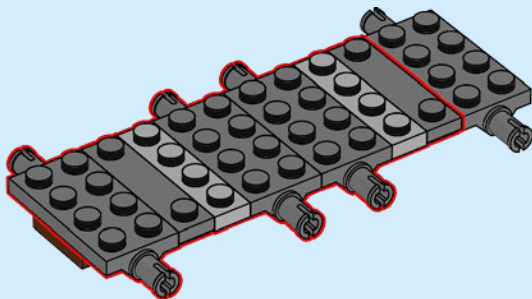

3

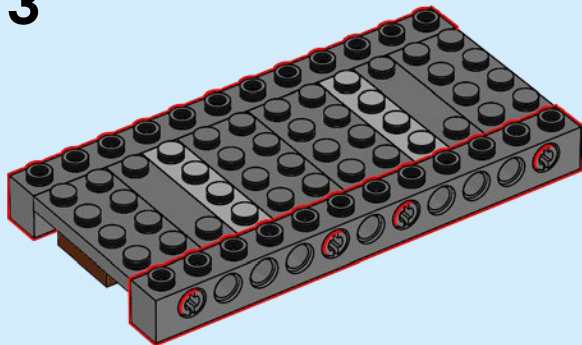

4

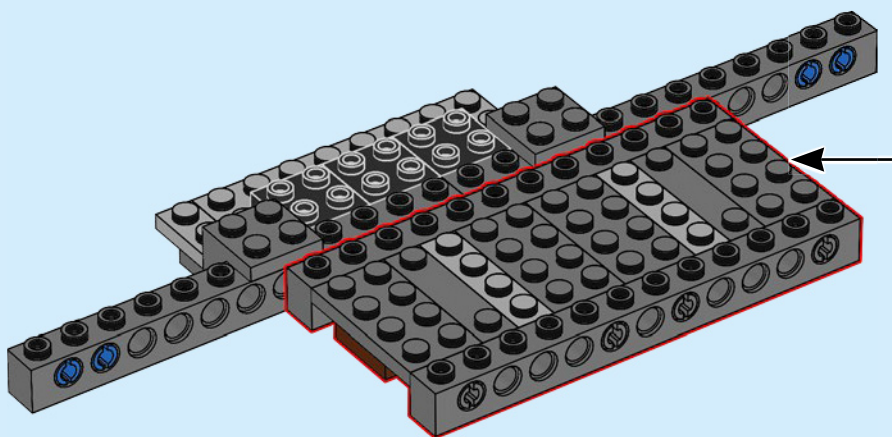
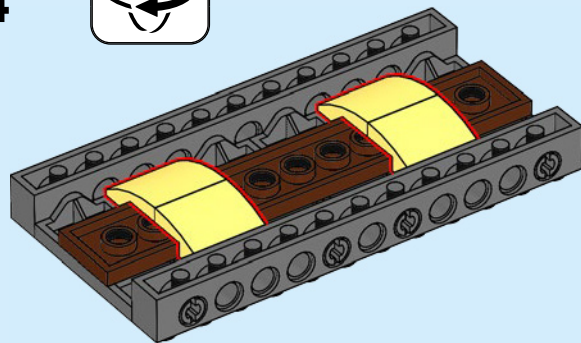

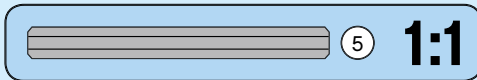
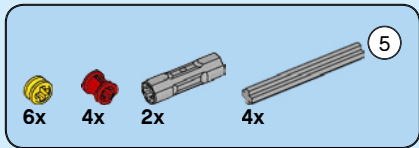

8

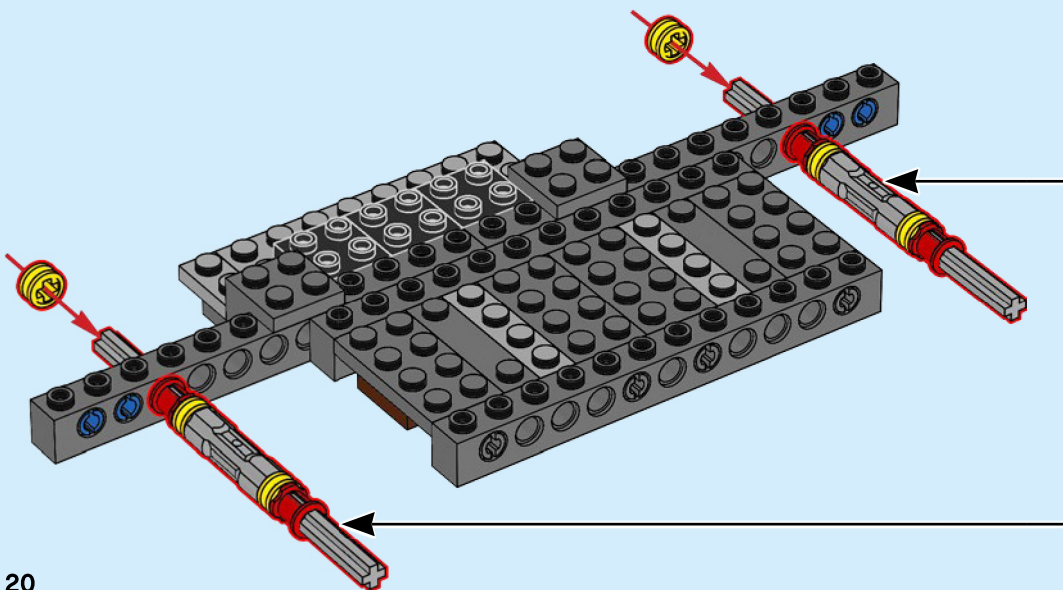
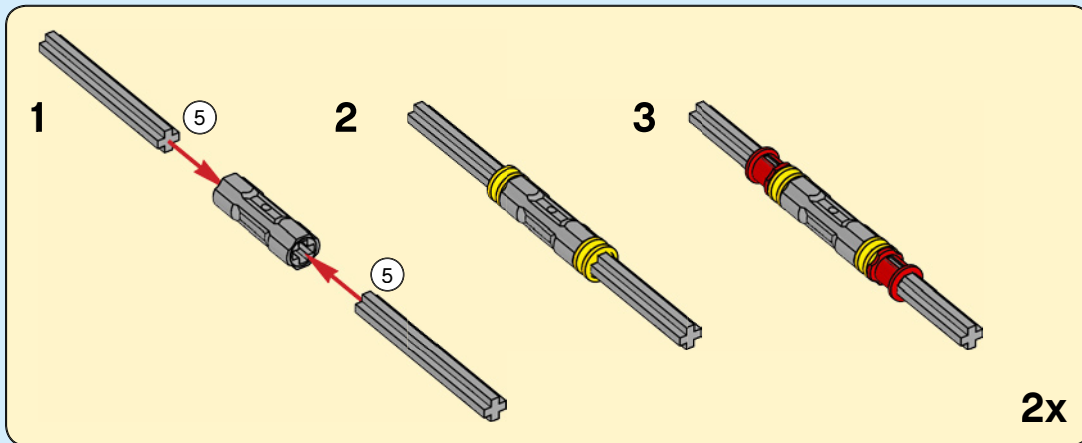

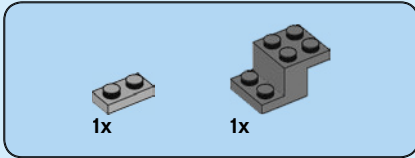
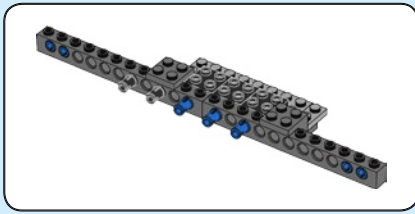

9

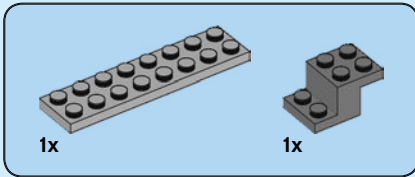
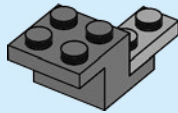

10

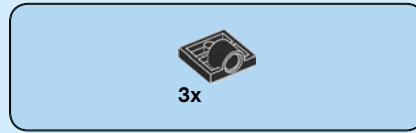
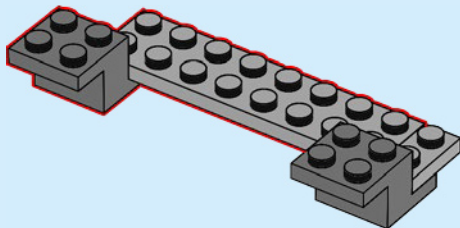

11

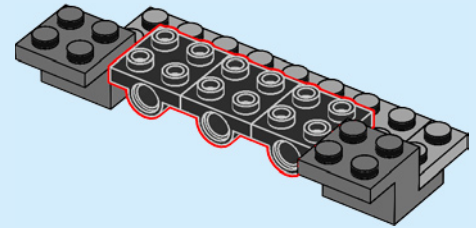

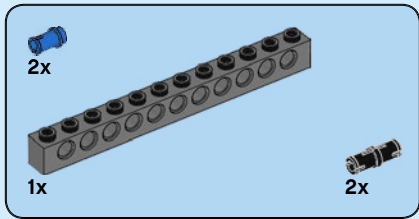

12

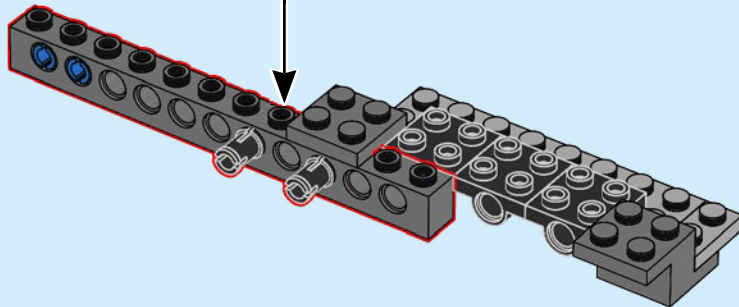
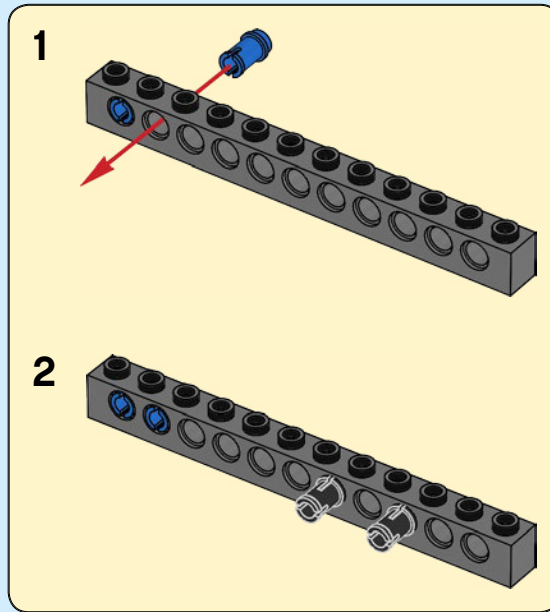

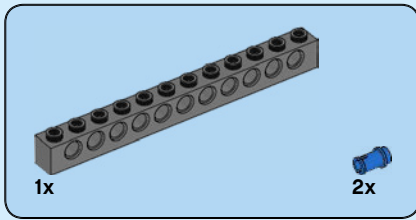

13

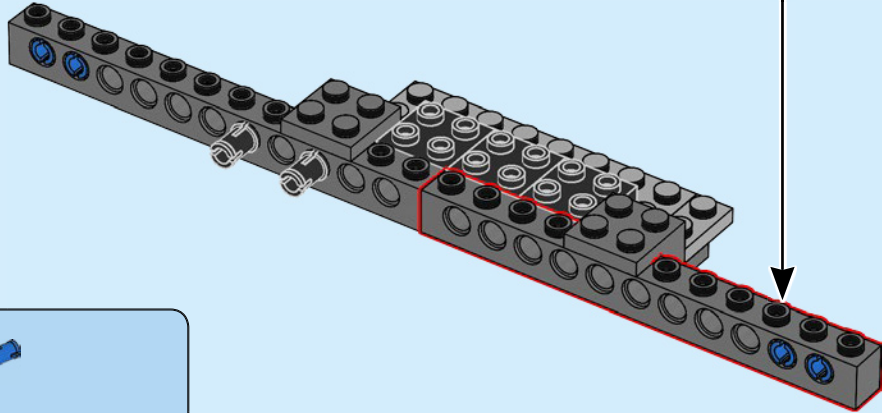
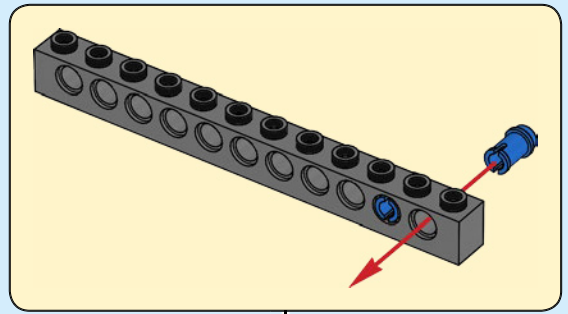

14

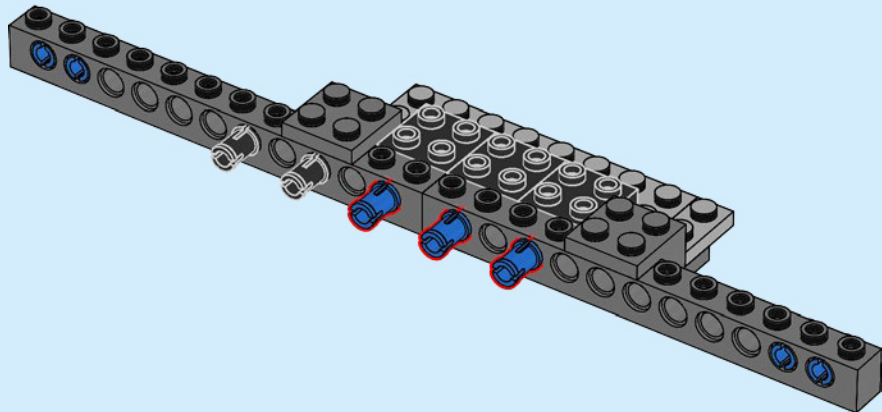

15

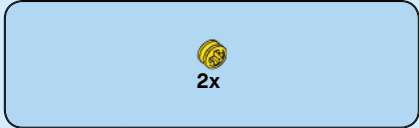
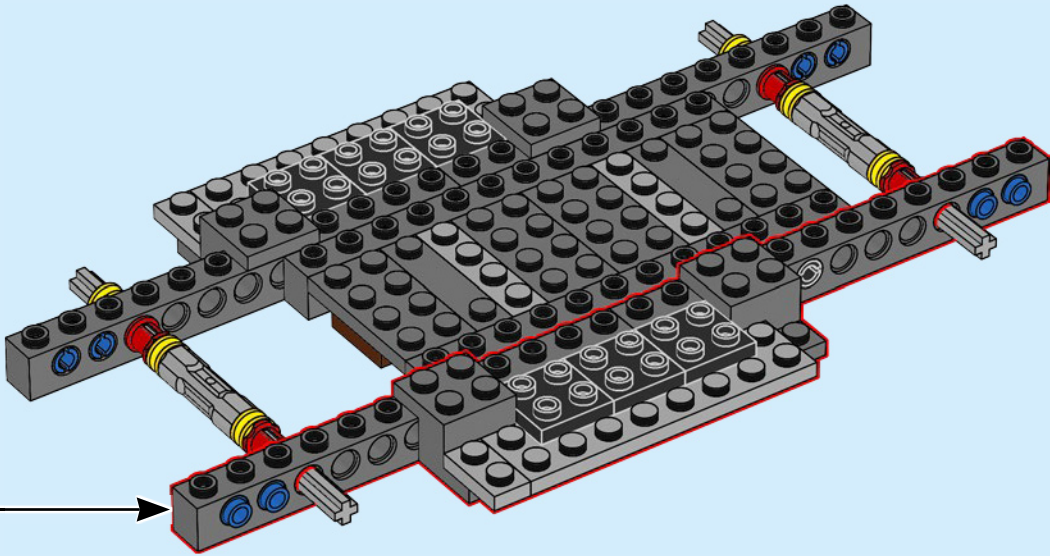

16

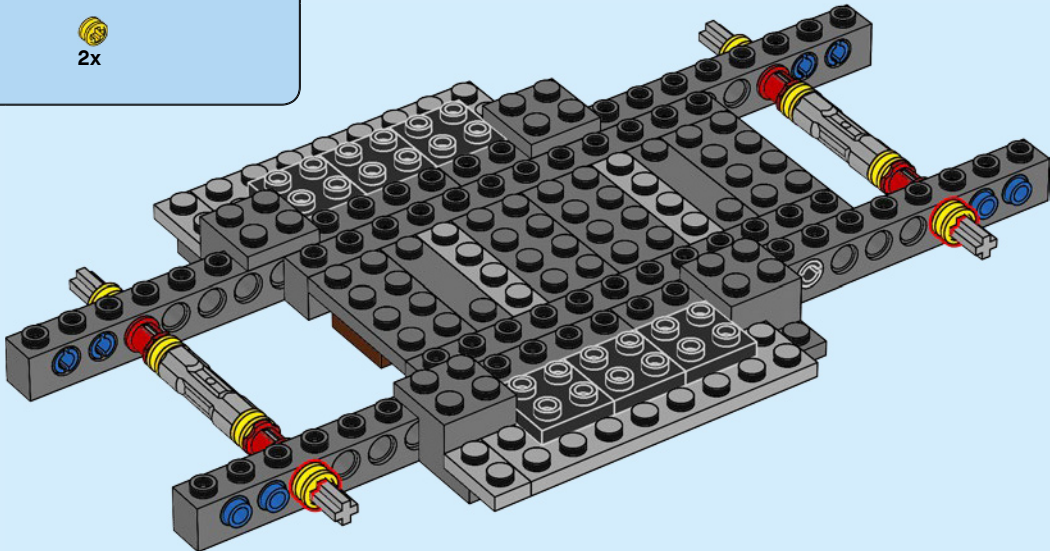

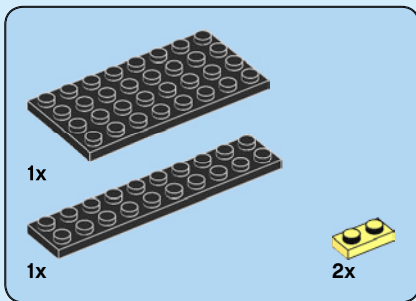

17

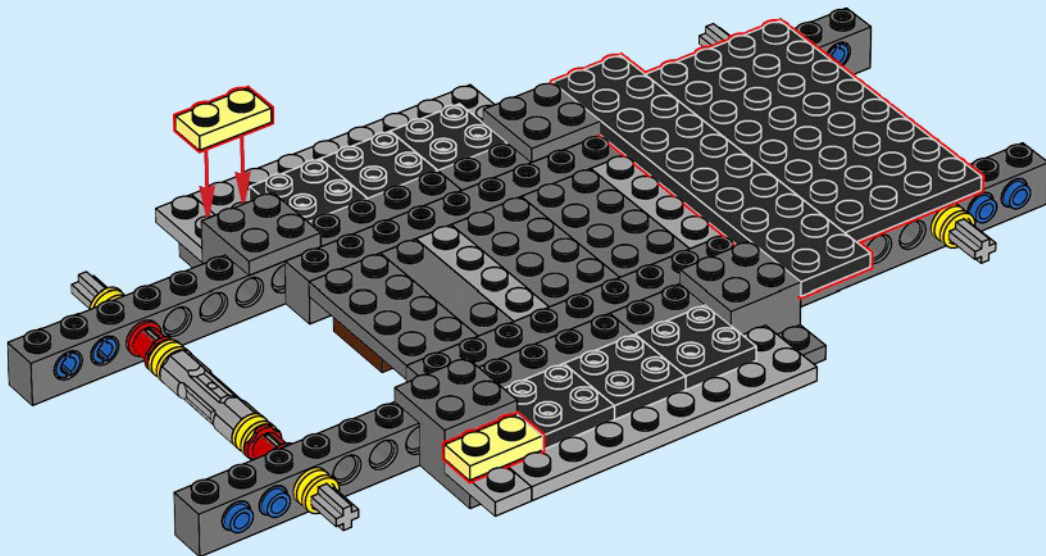

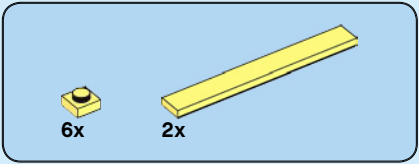

18

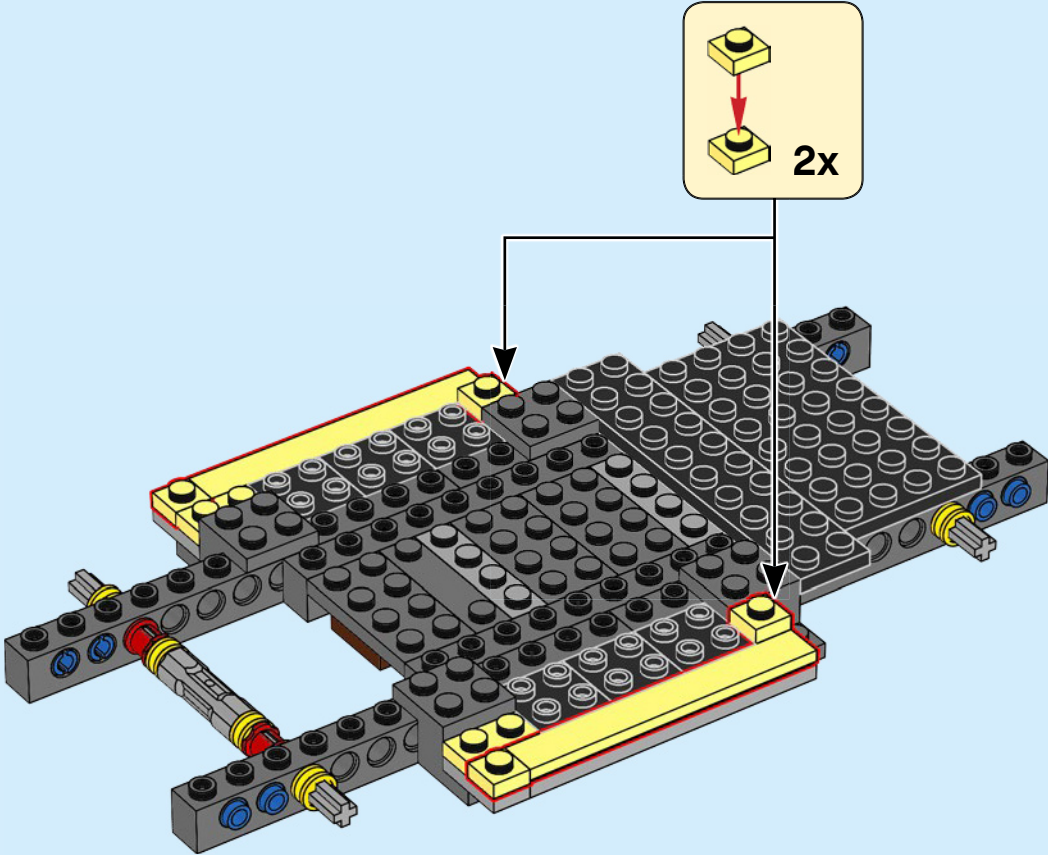

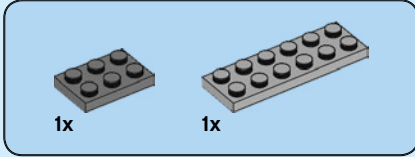
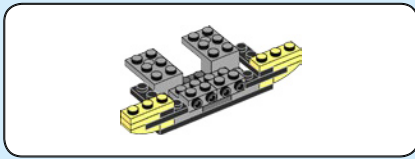

19

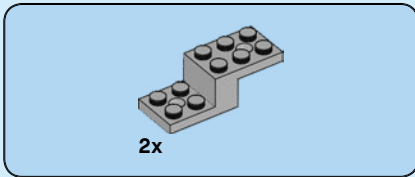
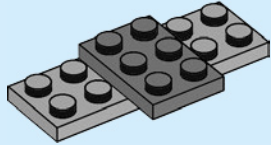

20

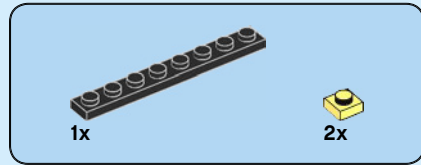
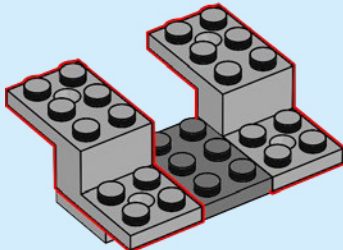

21

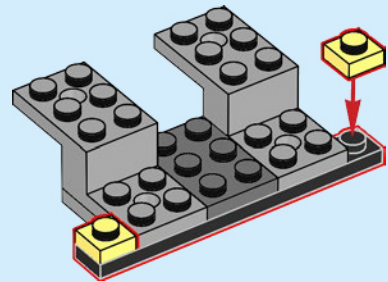



22

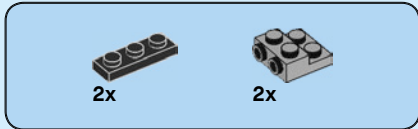
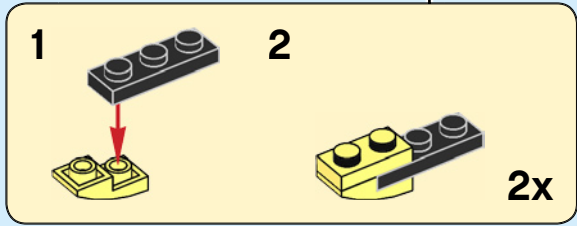
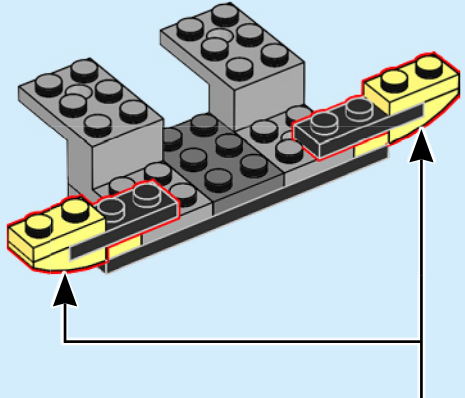

23

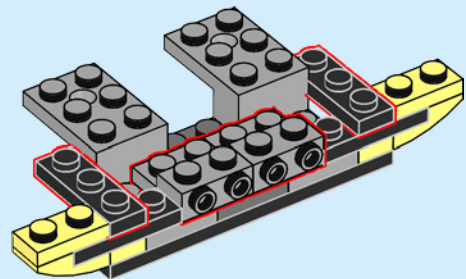

24

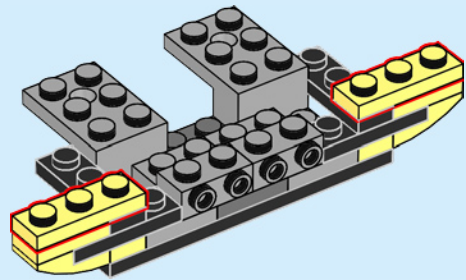

25

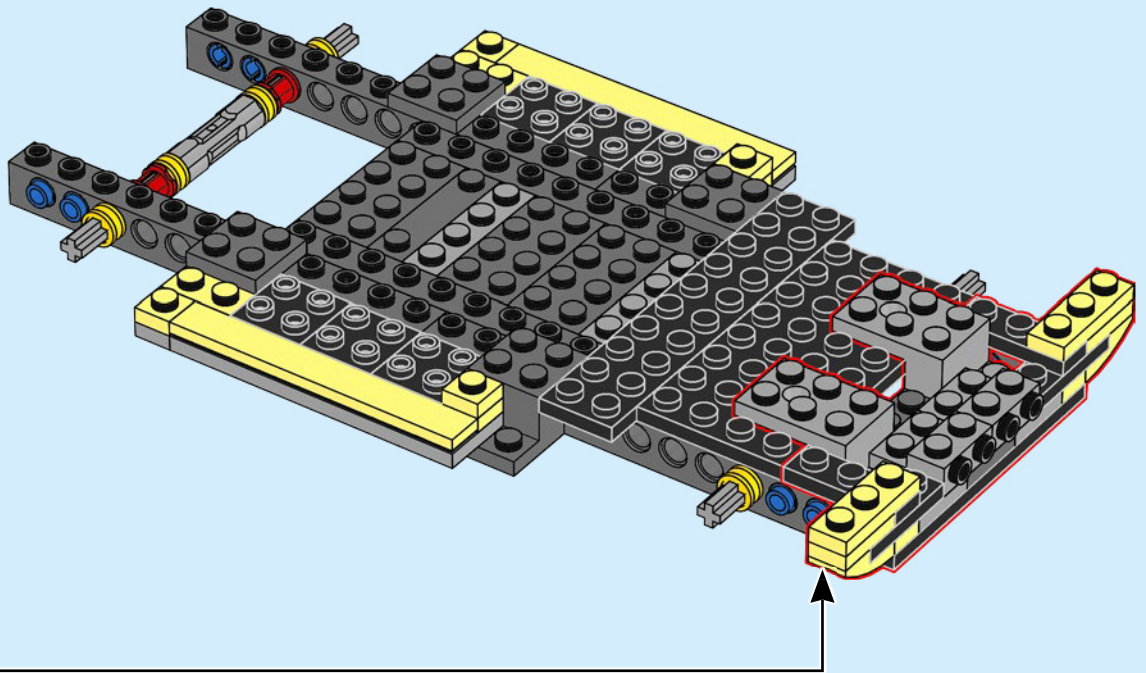

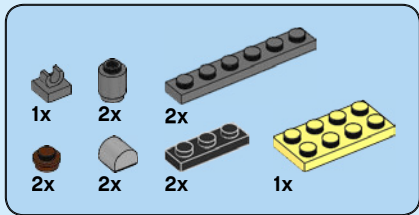

26

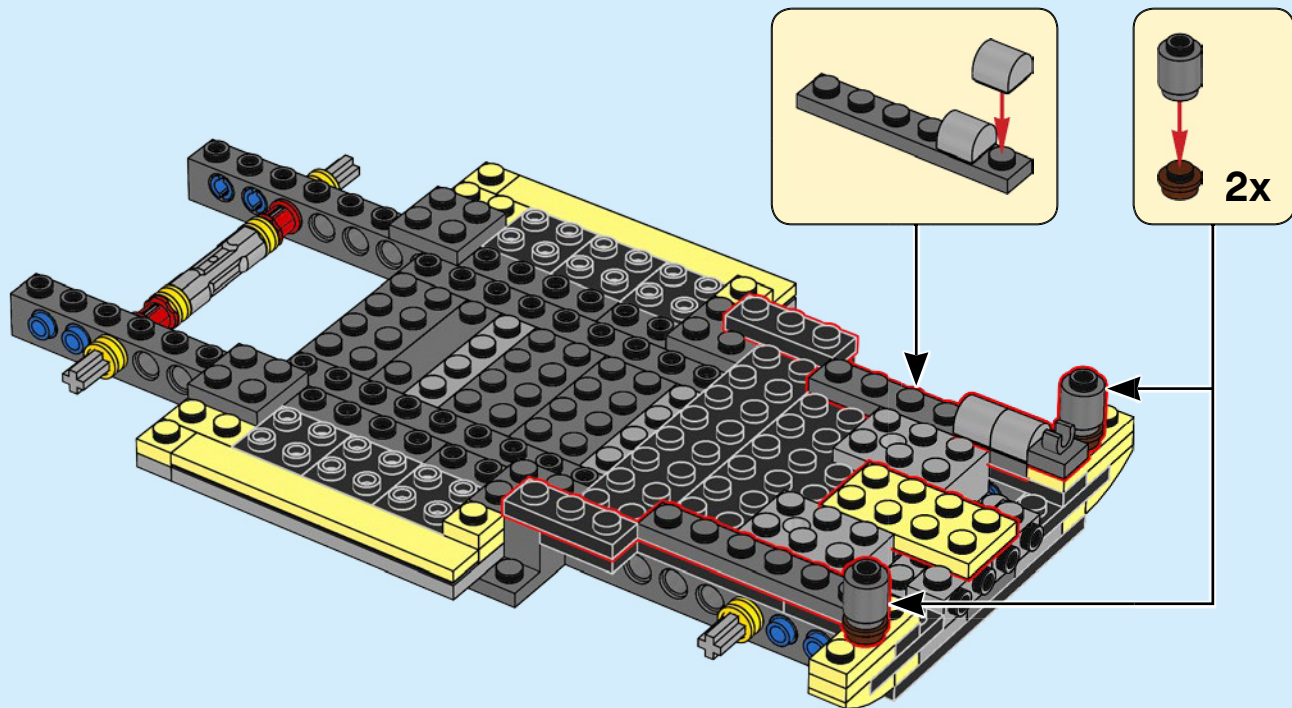

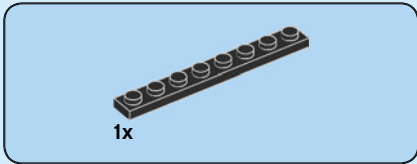
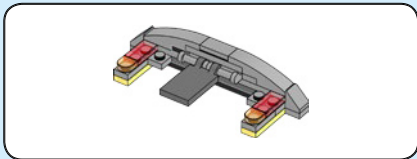

27

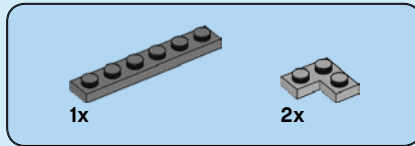
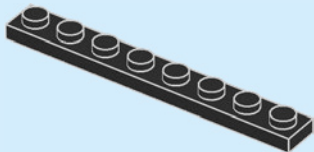

28

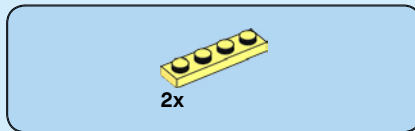
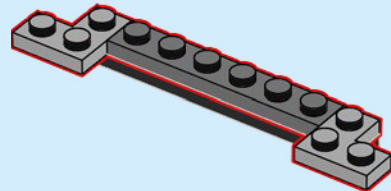

29

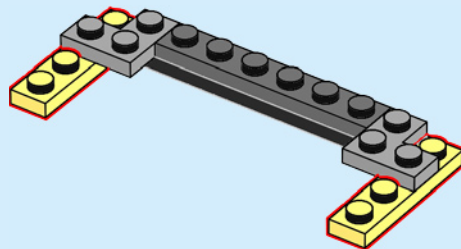

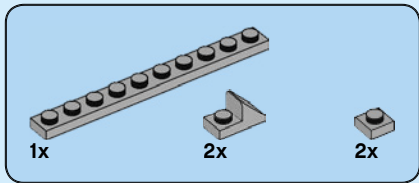

30

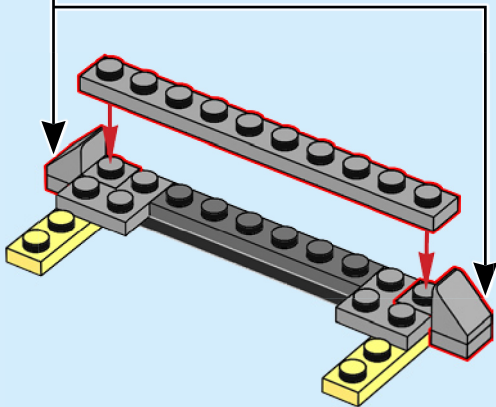
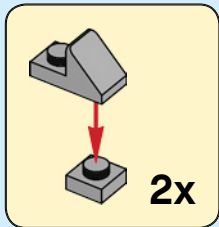

31

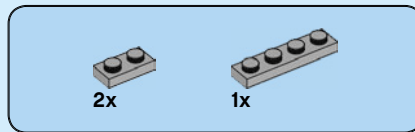
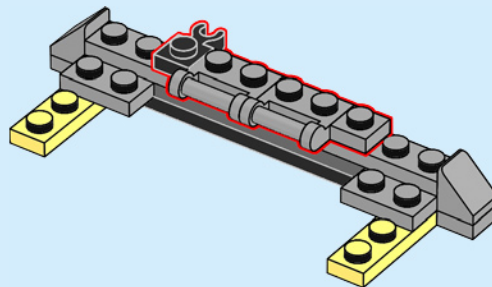

32

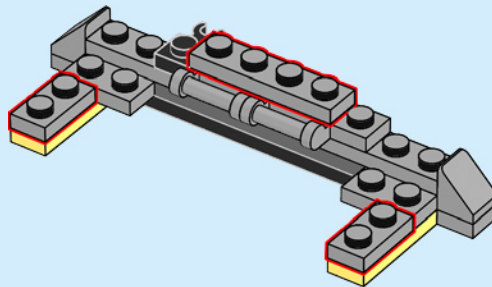

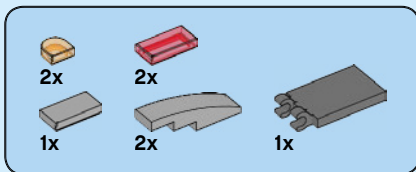

33

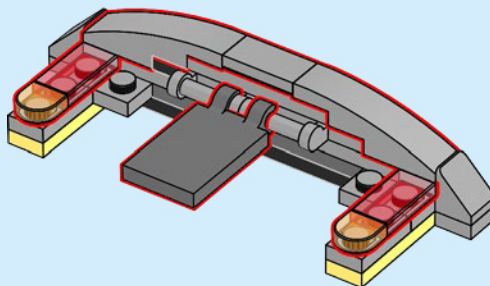

34

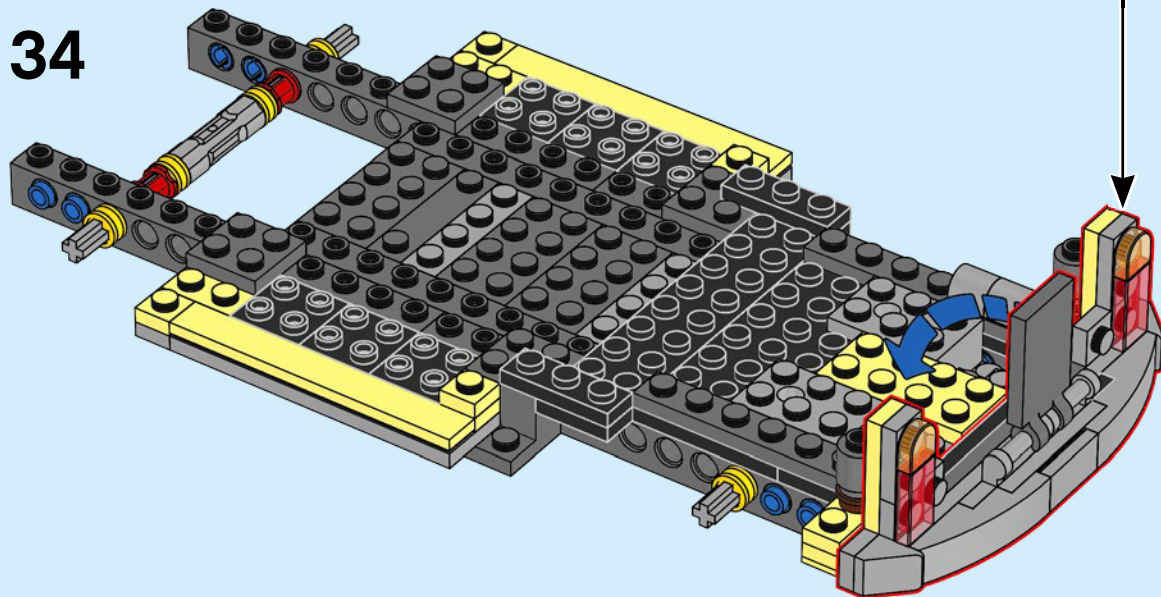

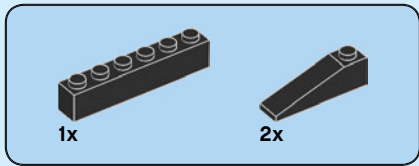

35

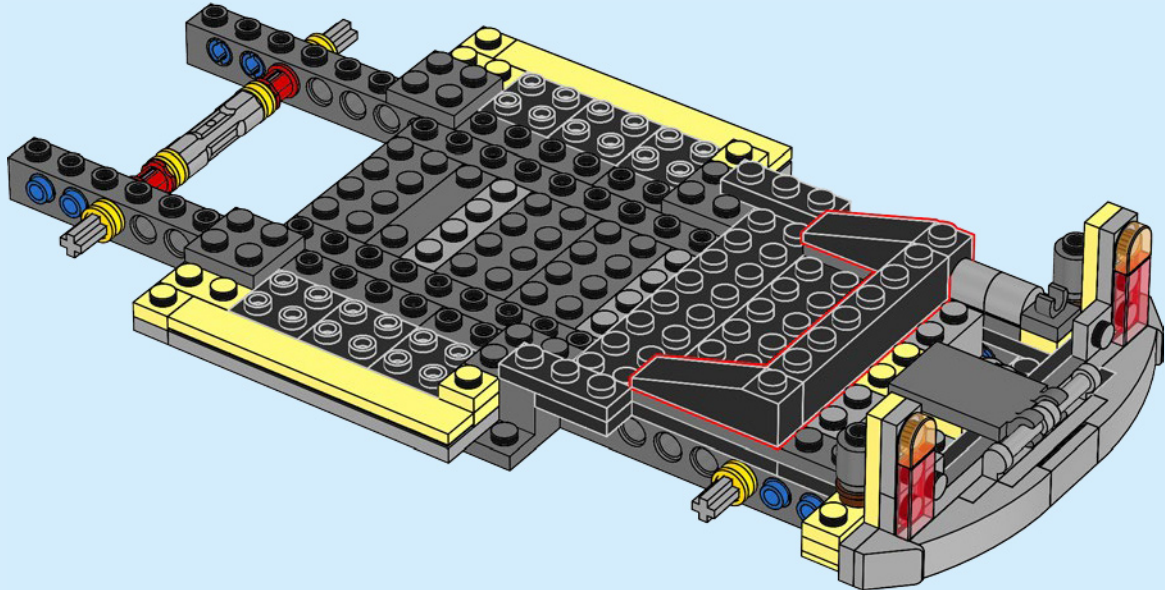

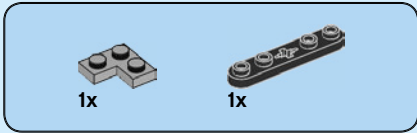

36

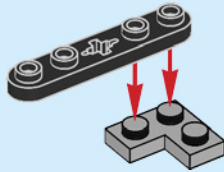

37

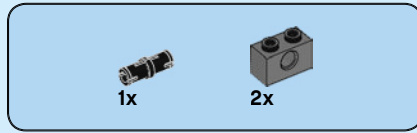
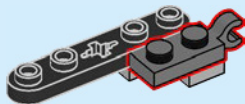

38

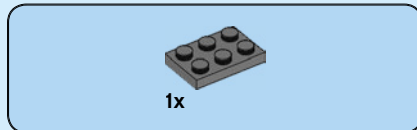
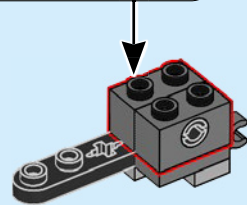
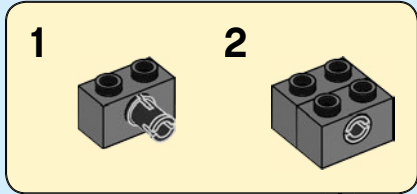

39

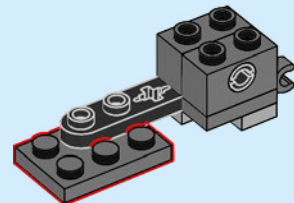



1x

40

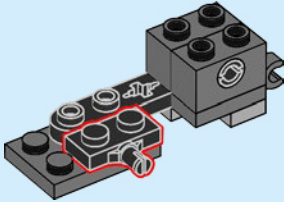

1x



1x

41

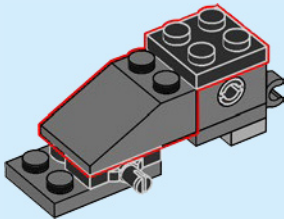

1x



1x



1x

42

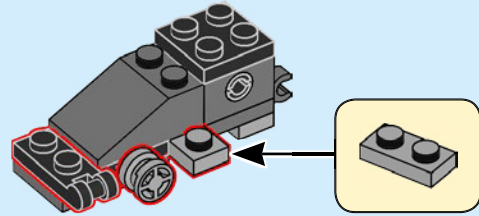

1x



1x



1x

43

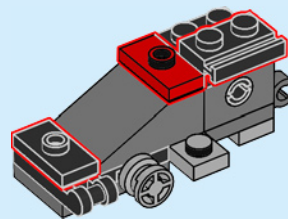





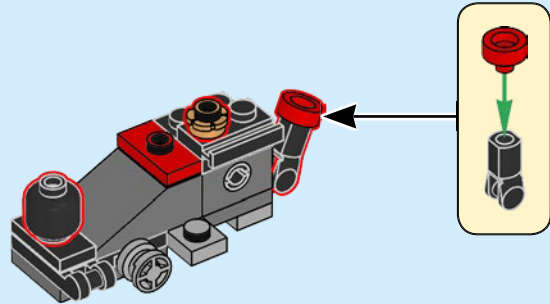

44

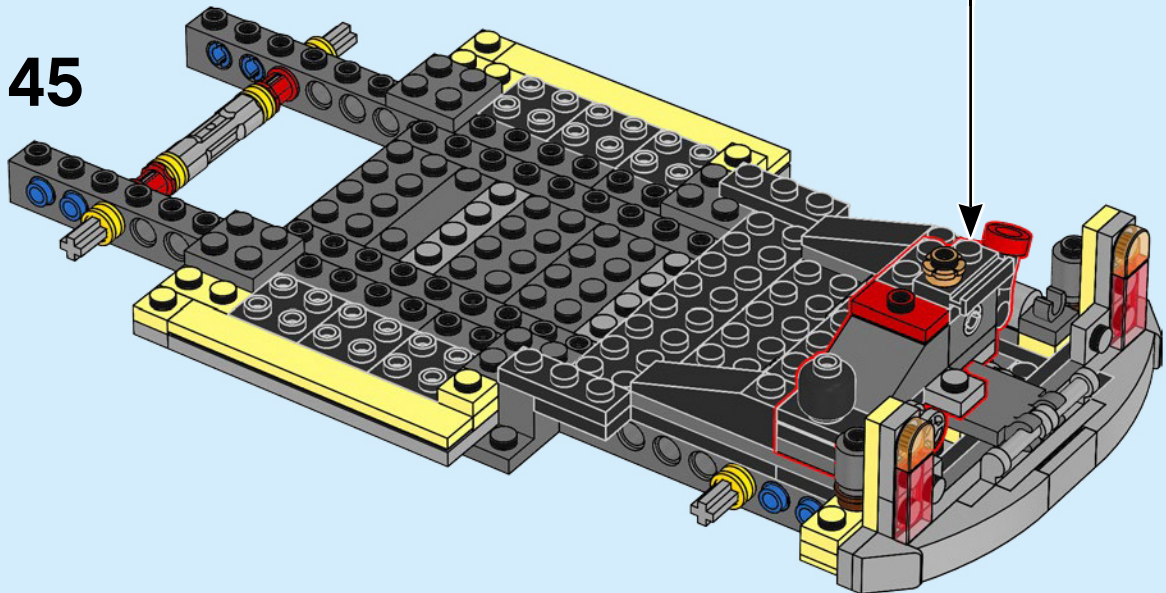



45

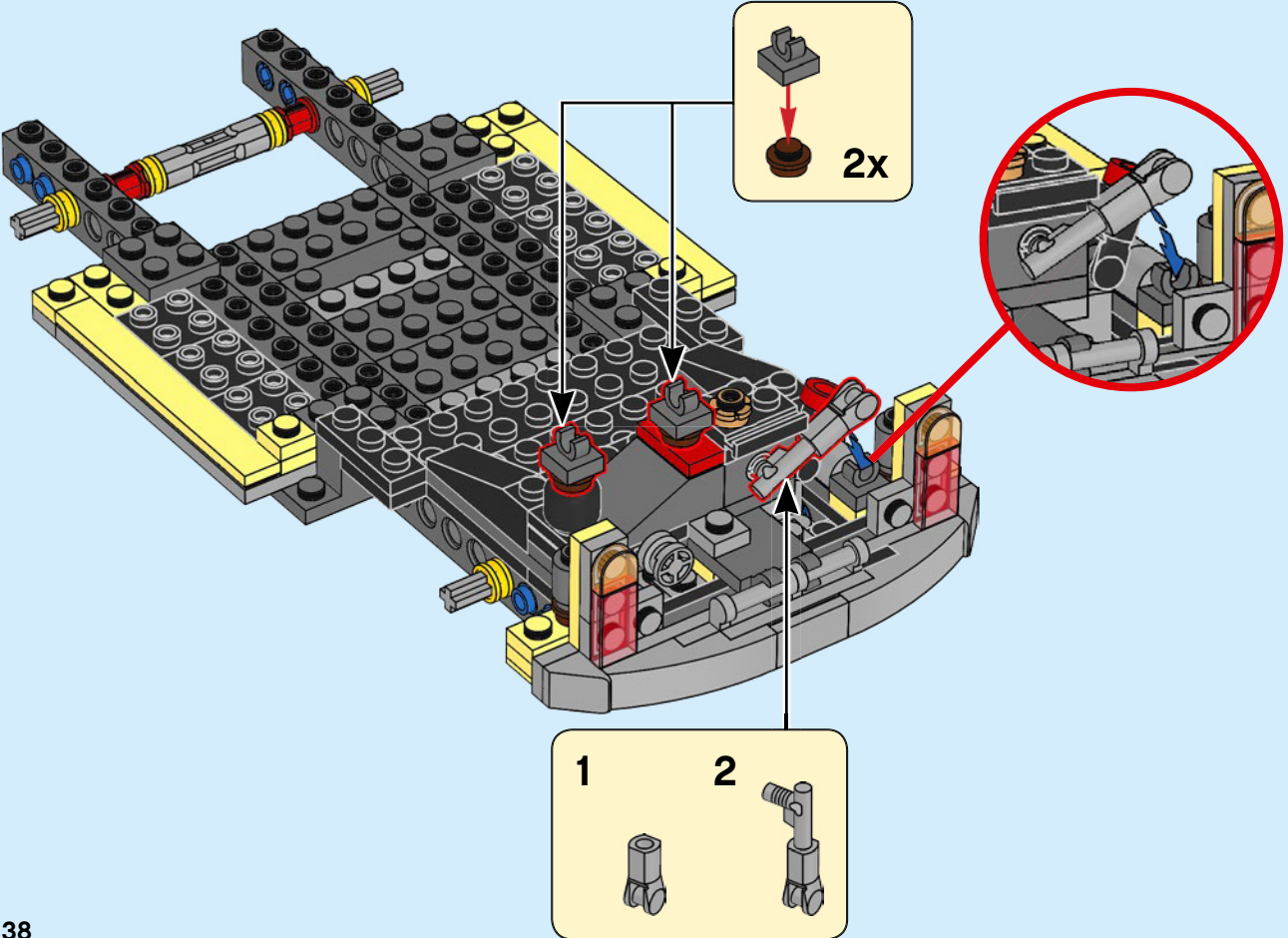

			
2x	2x	1x	1x

46

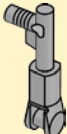

1	2
	

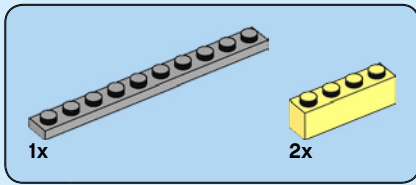

47

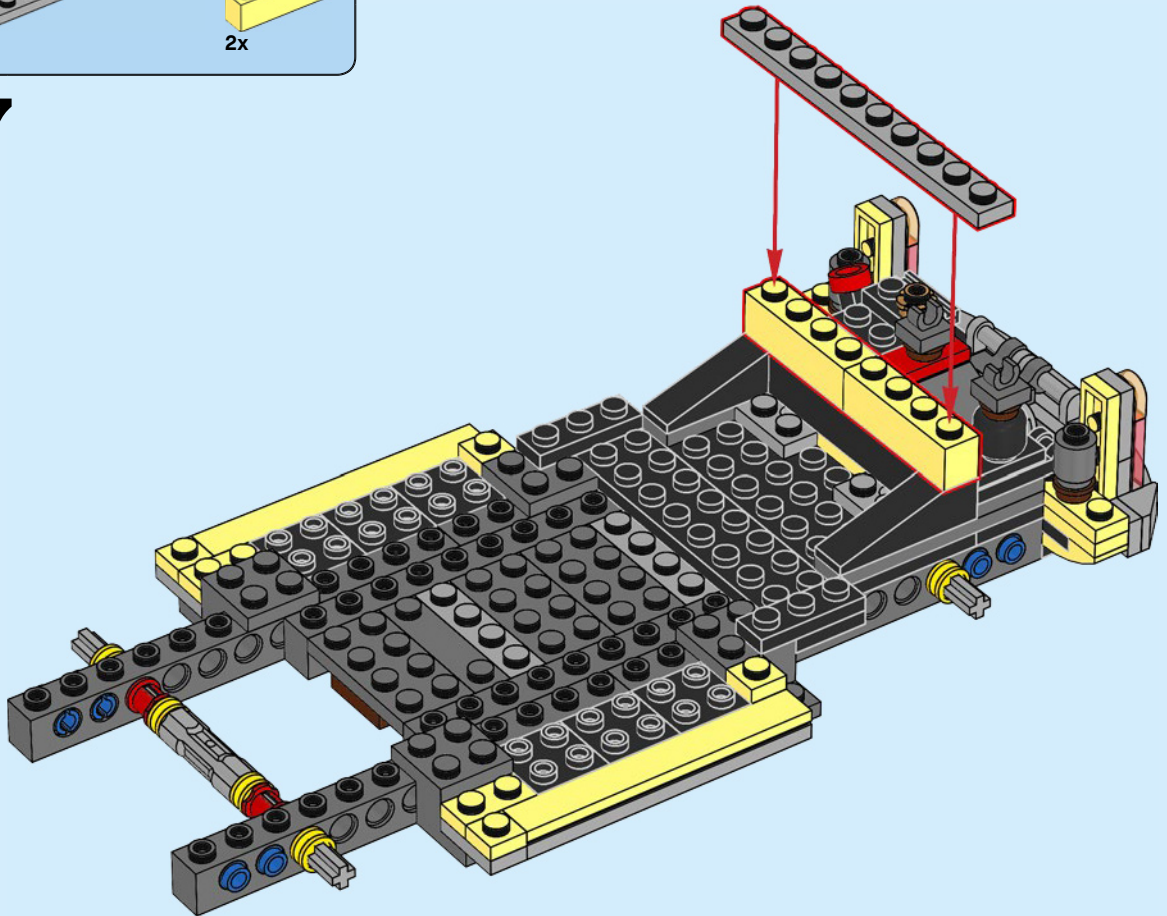

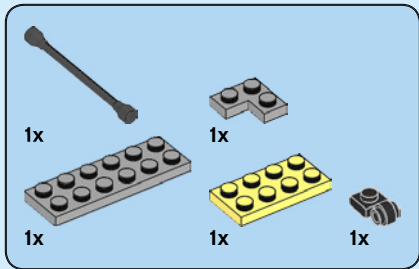

48

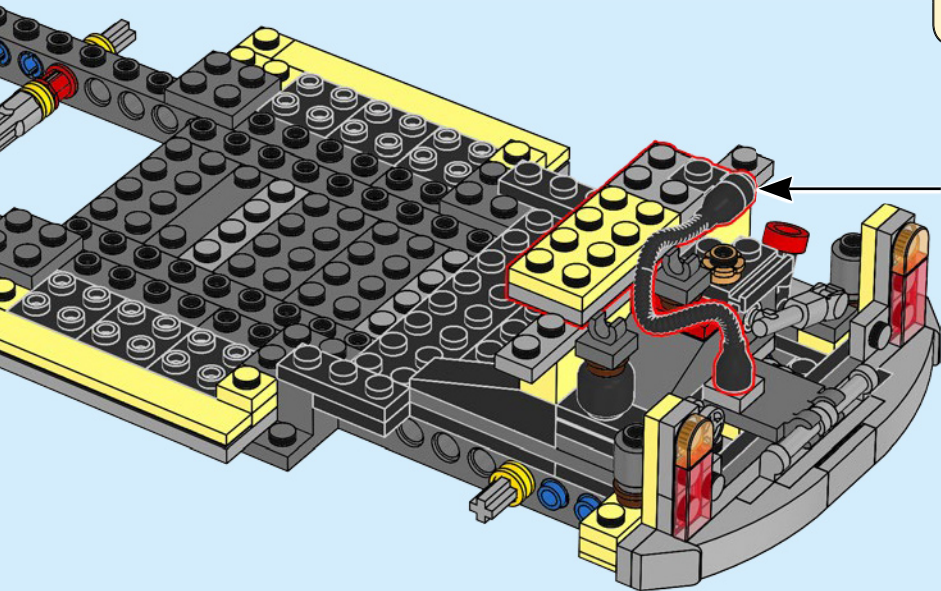
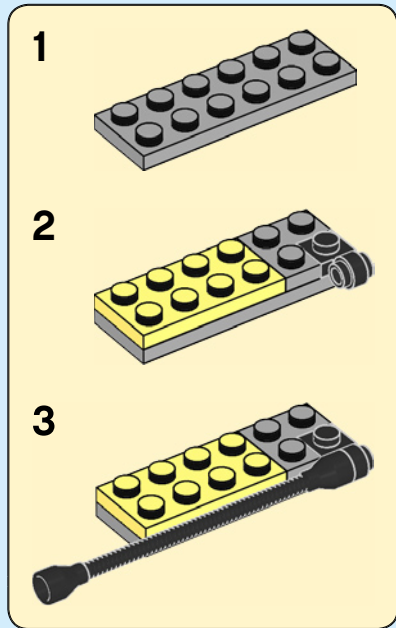

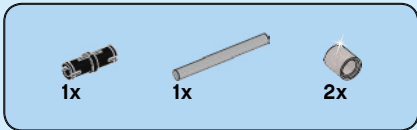

49

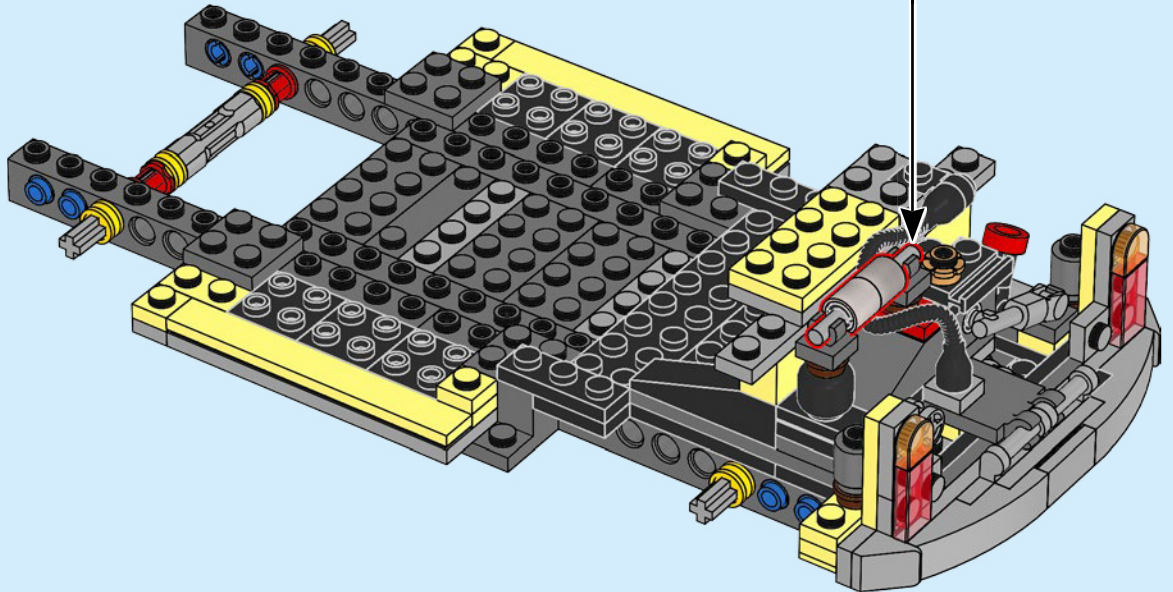
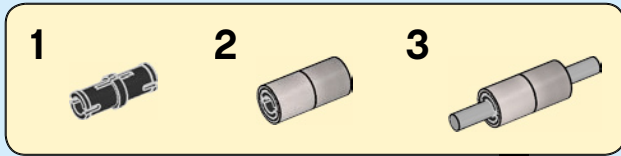

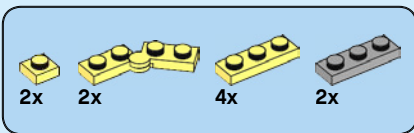

50

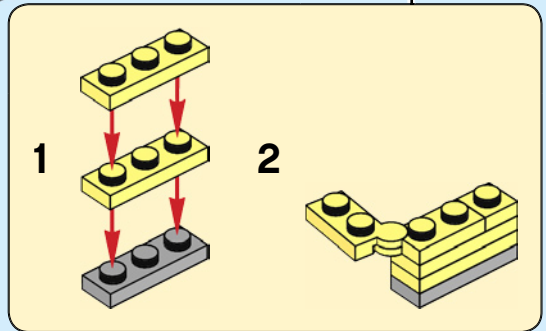
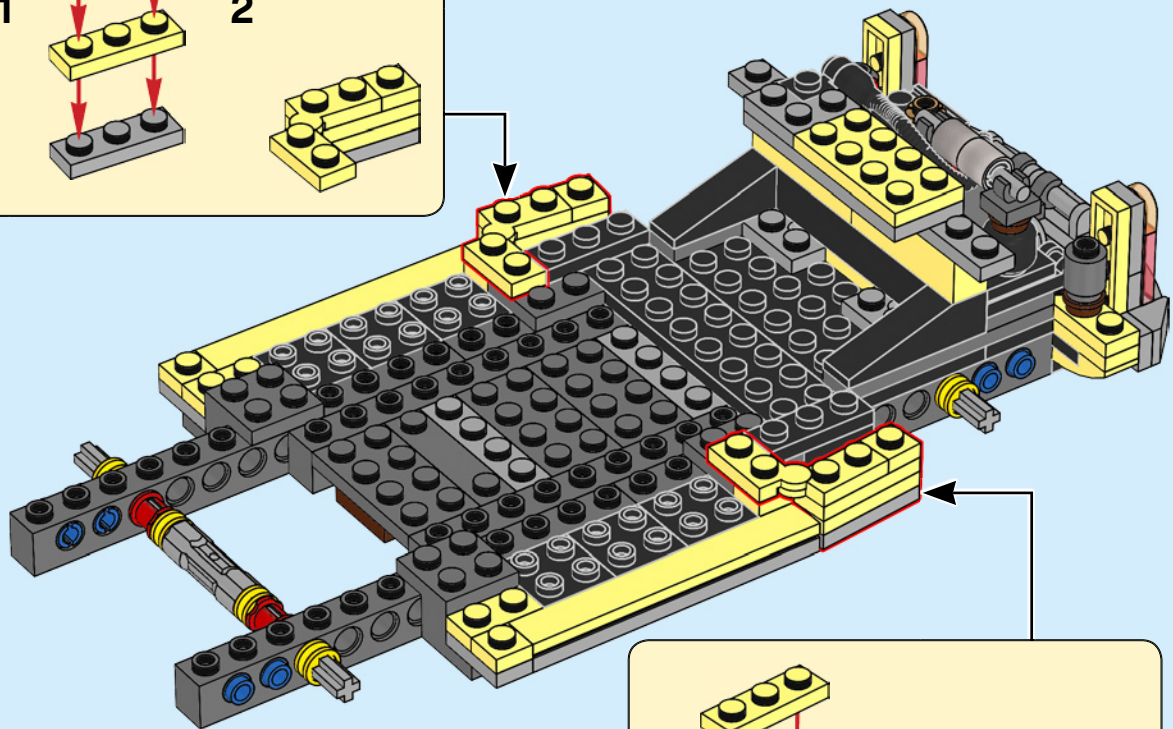
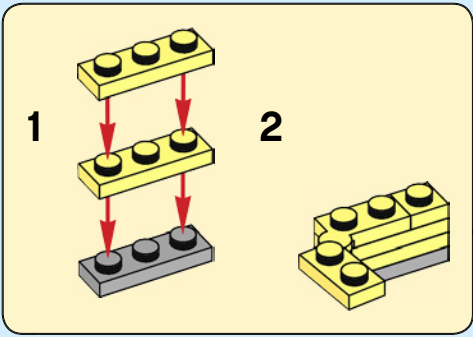

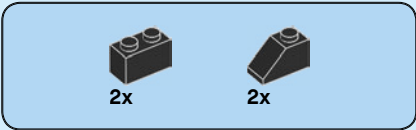

51

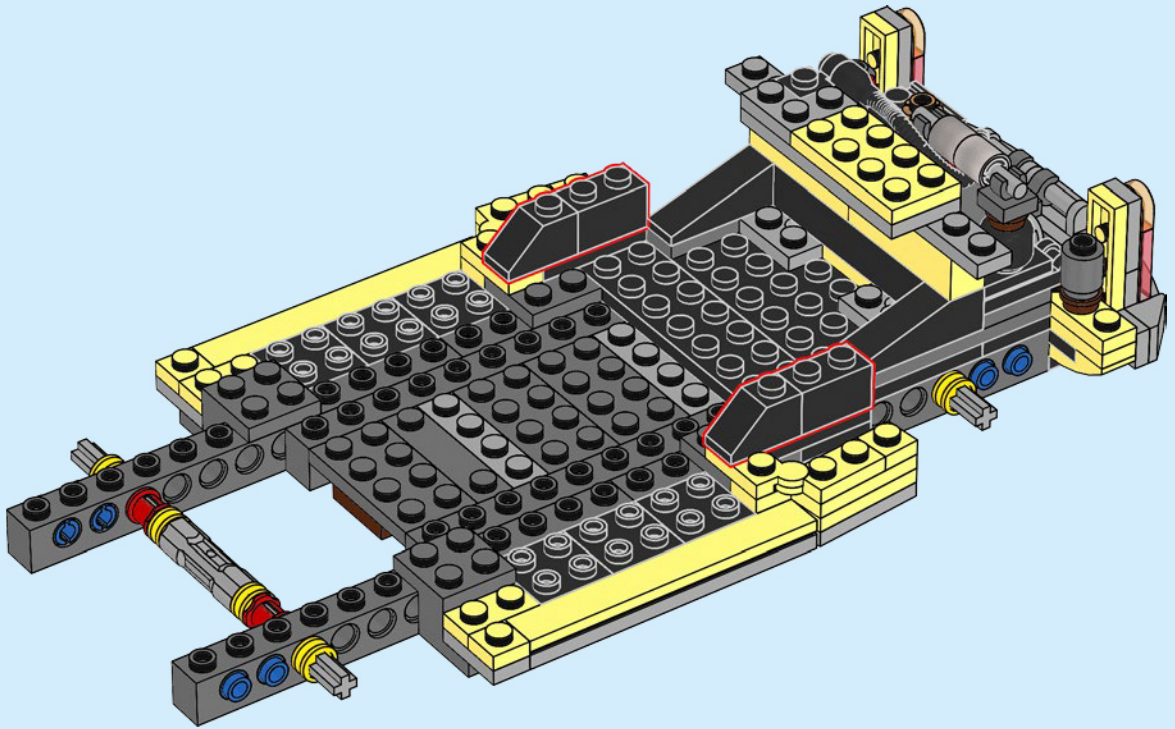

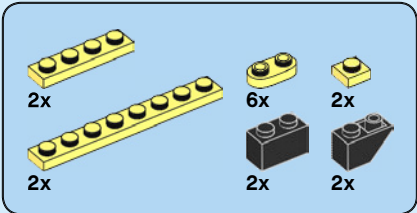

52

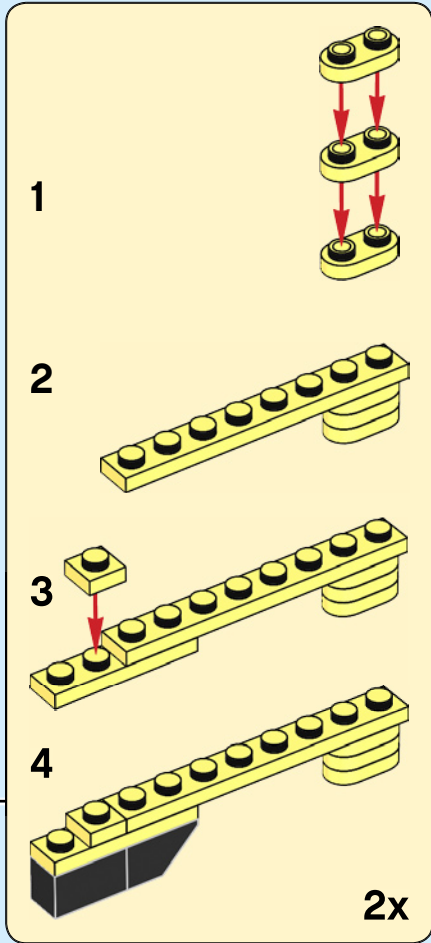
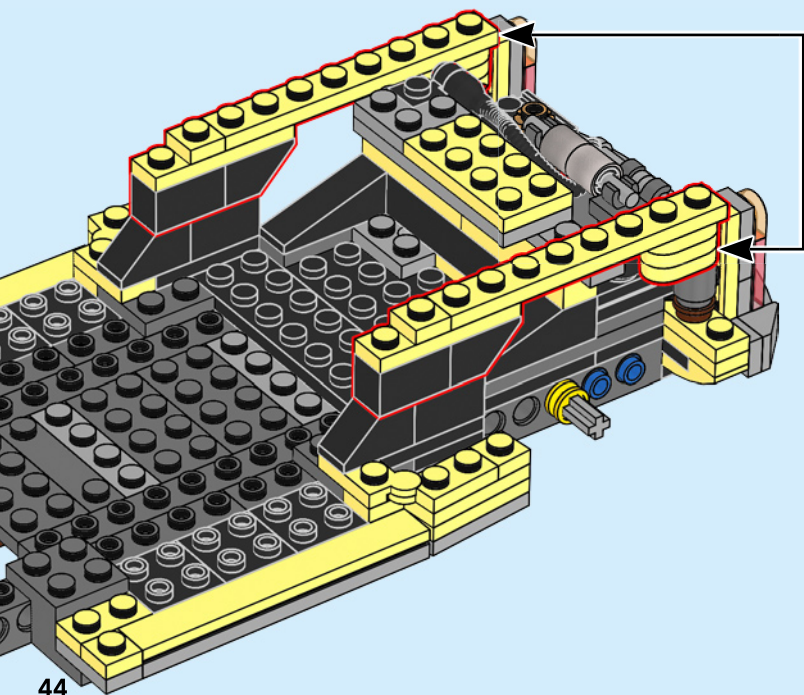



2x

53

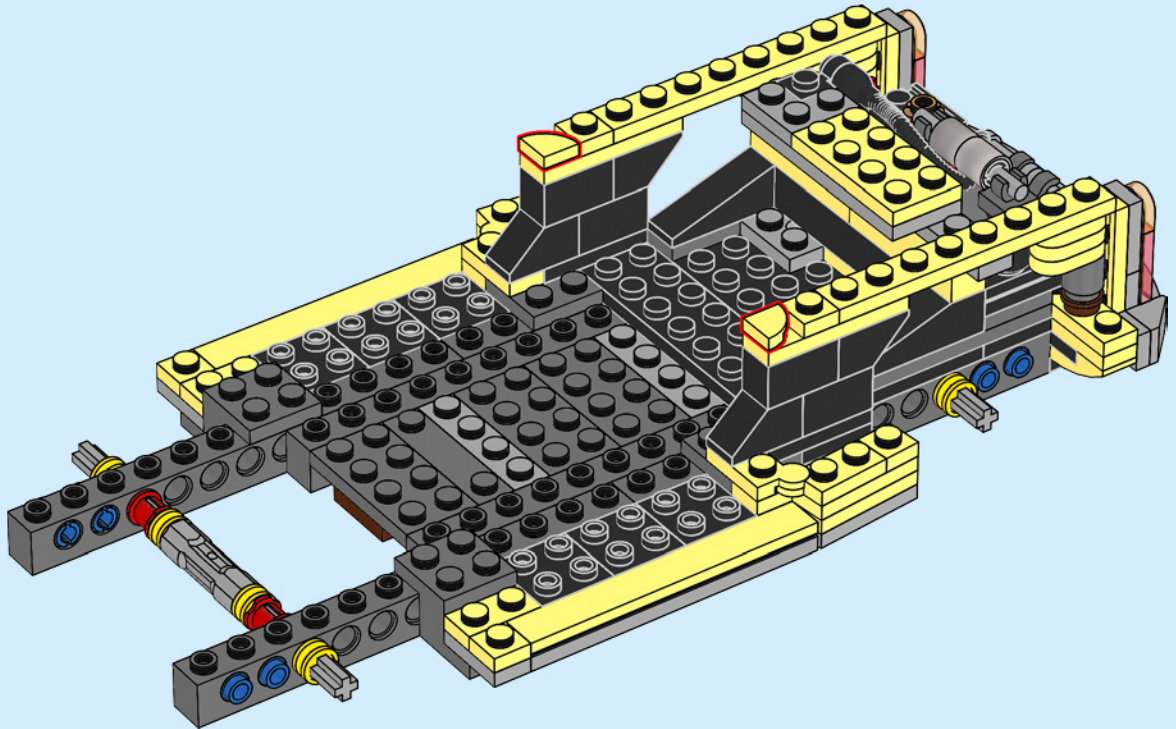

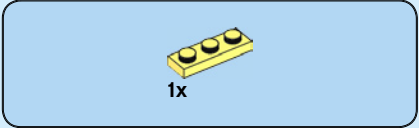
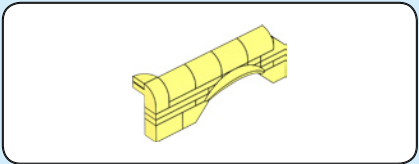

54

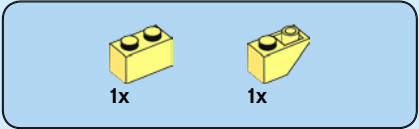
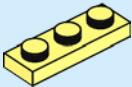

55

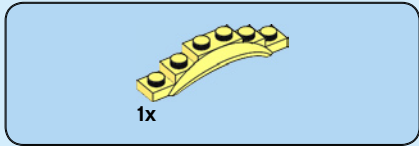
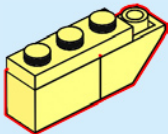

56

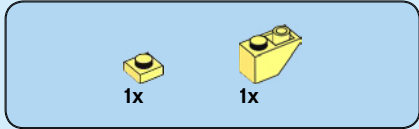
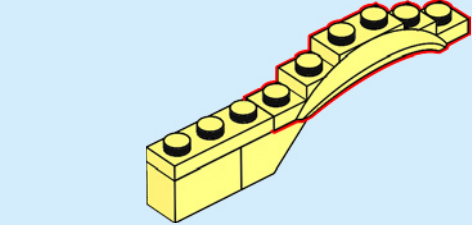

57

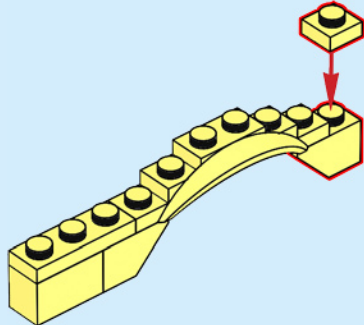

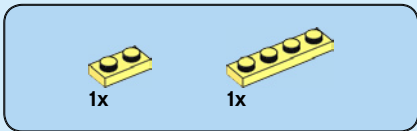

58

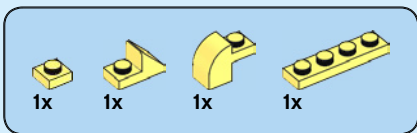
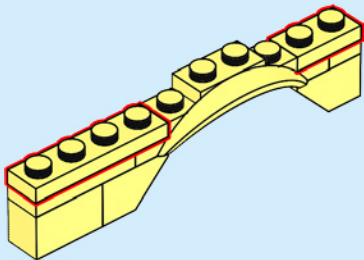

59

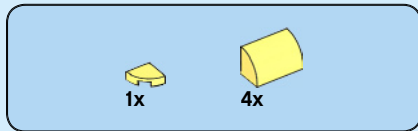
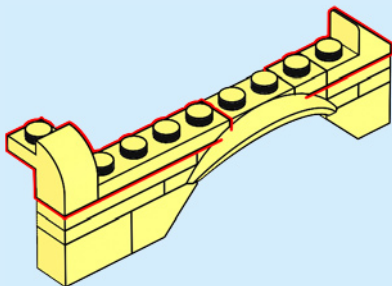

60

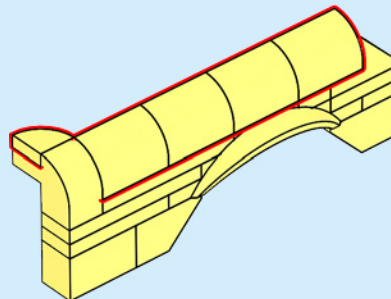

61

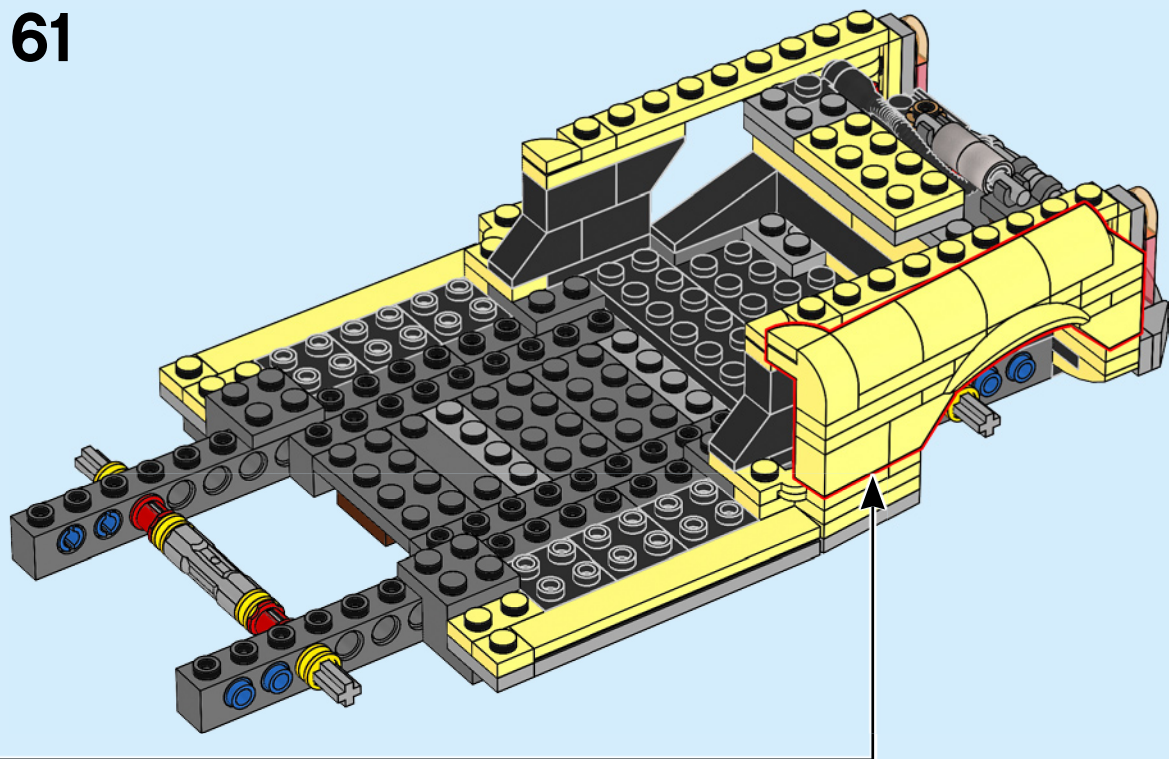

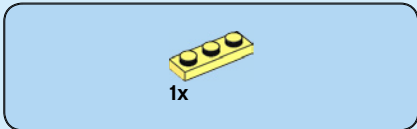
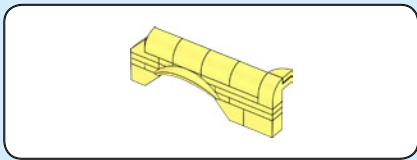

62

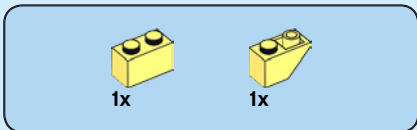
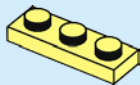

63

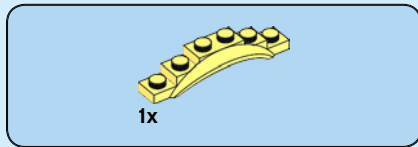
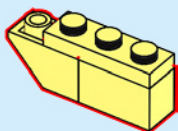

64

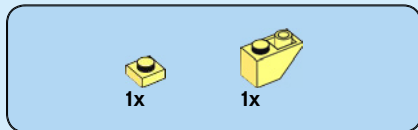
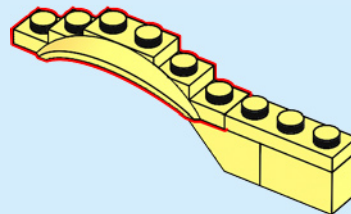

65

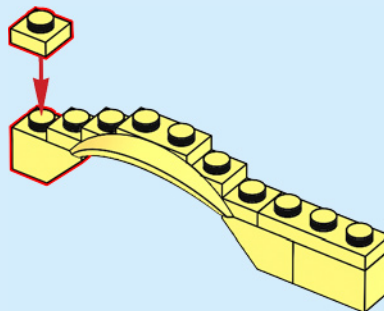

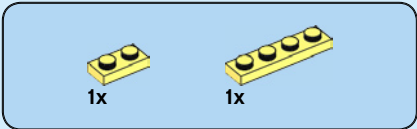

66

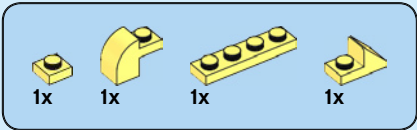
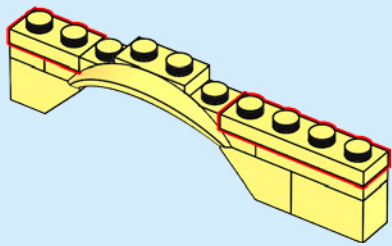

67

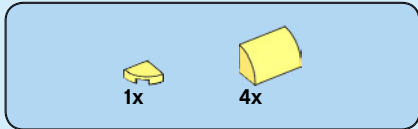
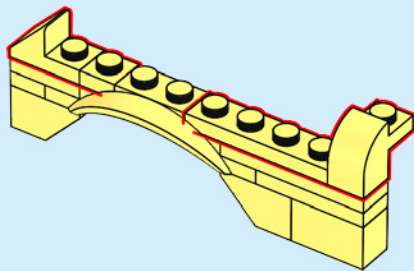

68

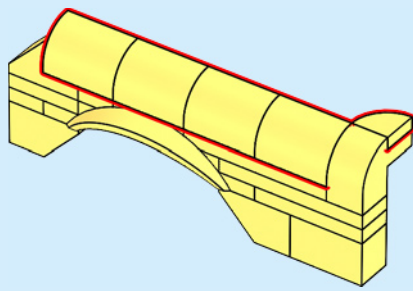

69

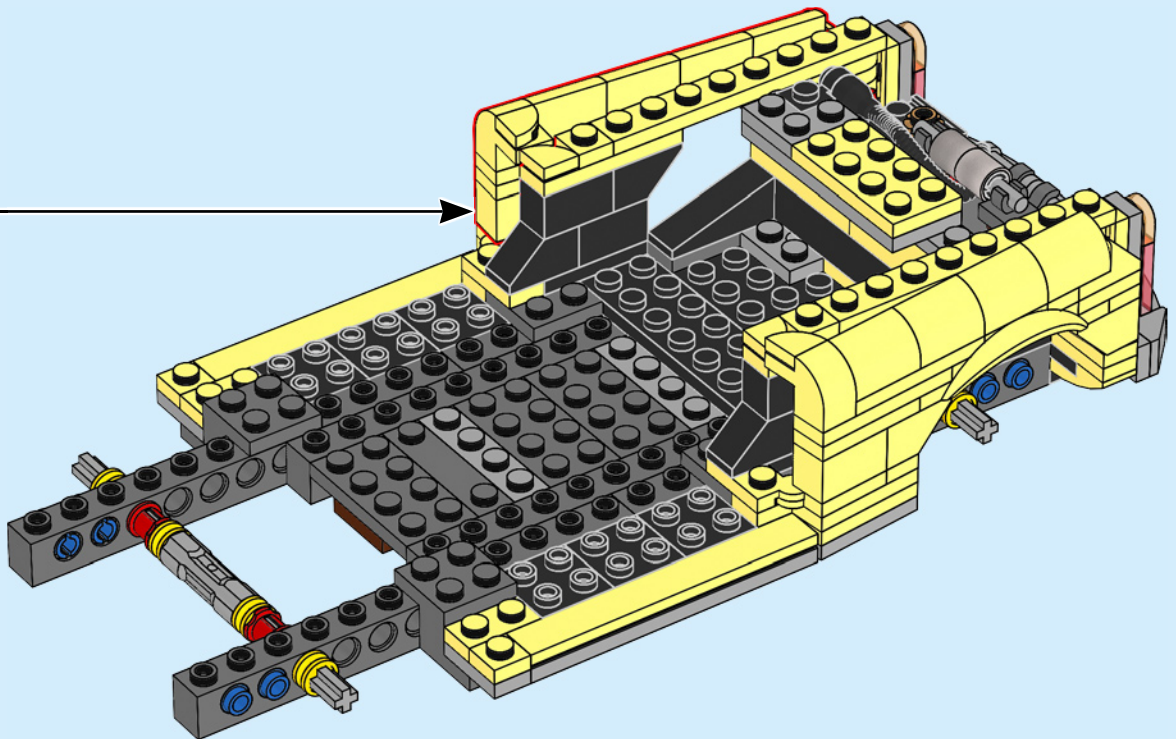

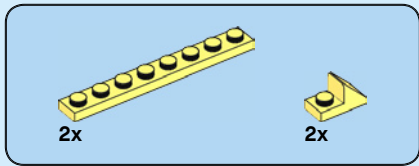

70

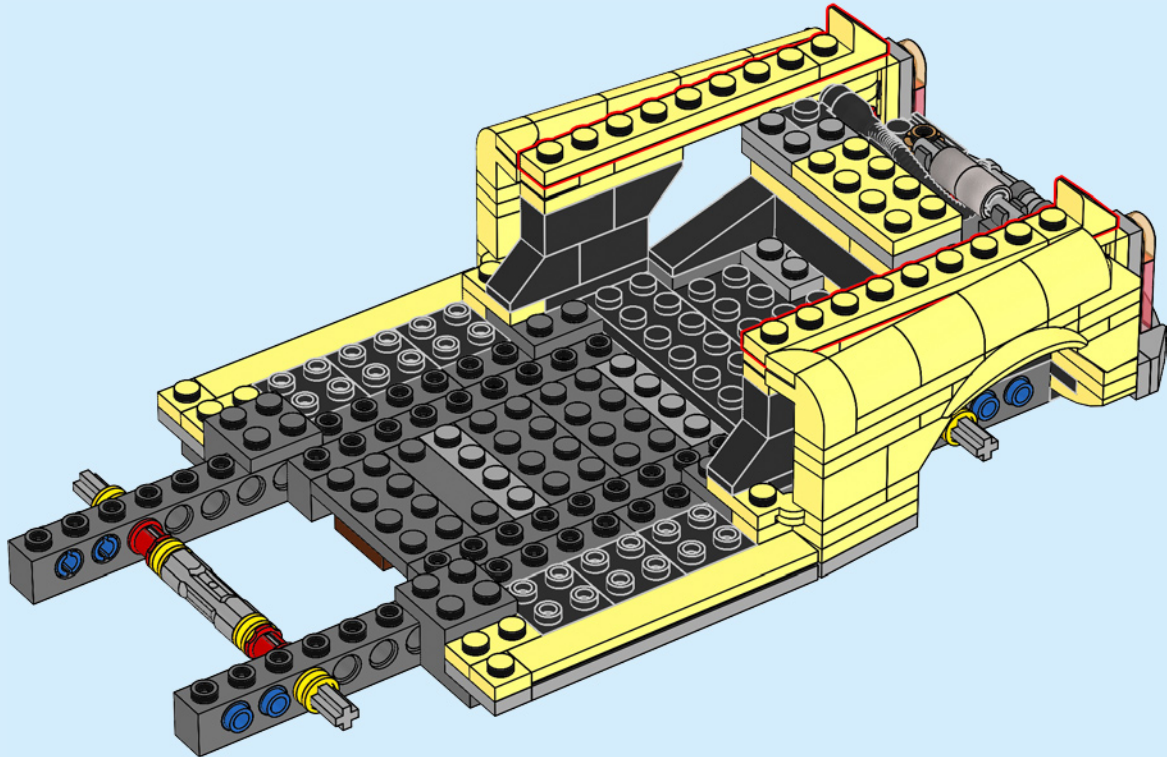

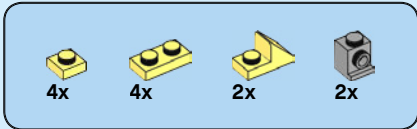

71

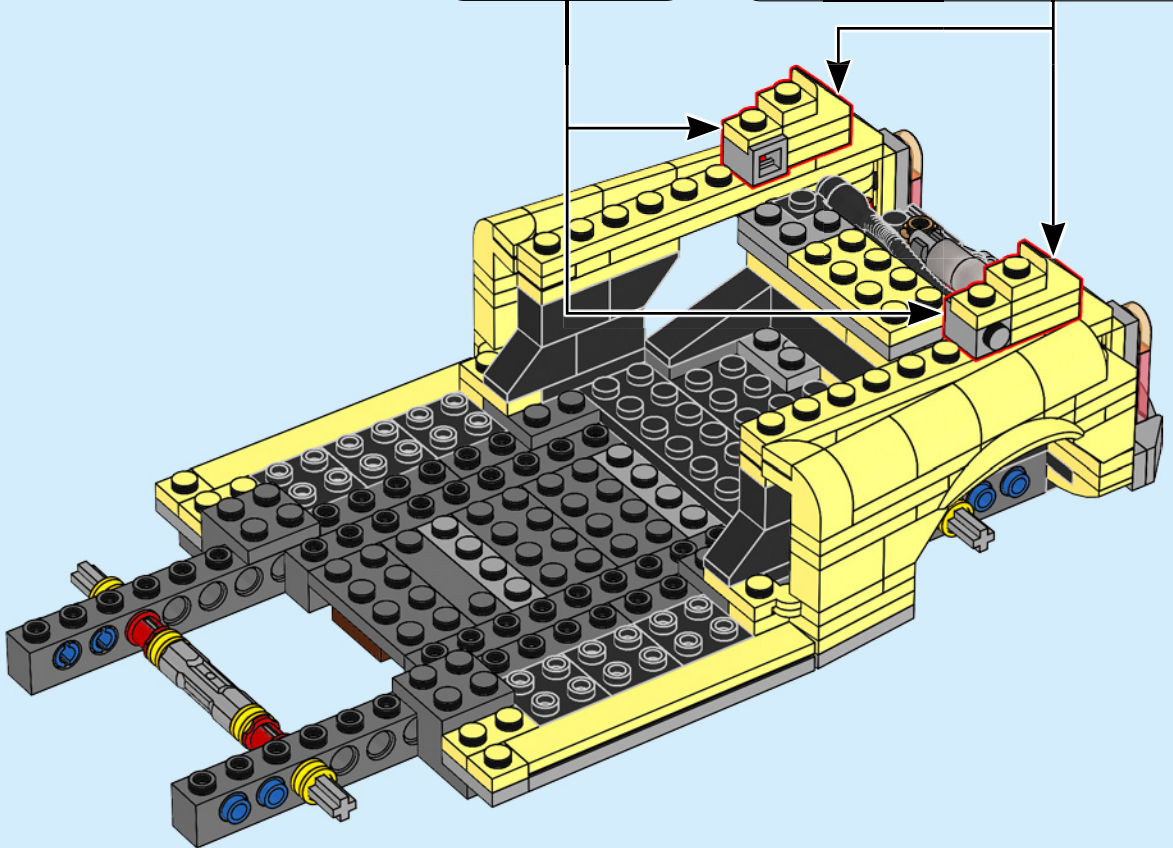
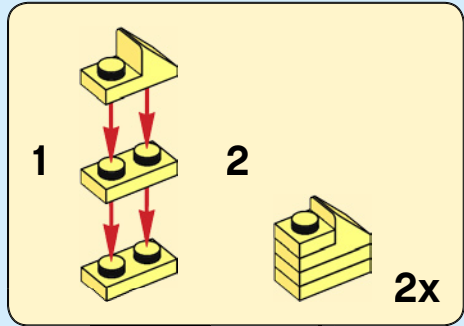
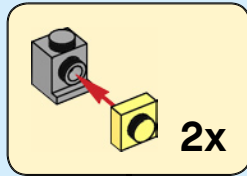

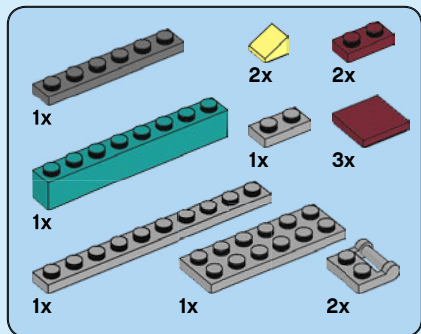

72

1

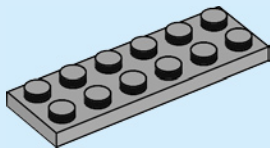

2

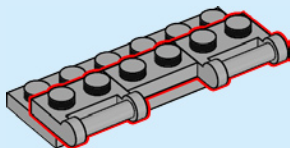

3

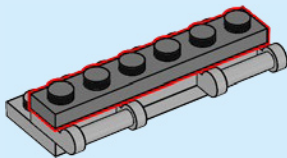

4

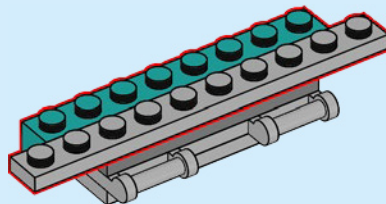

5

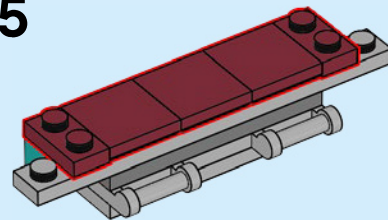

6

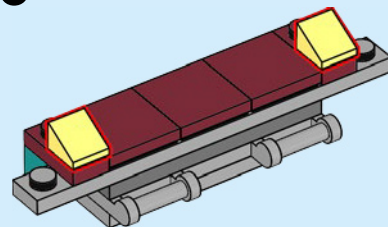

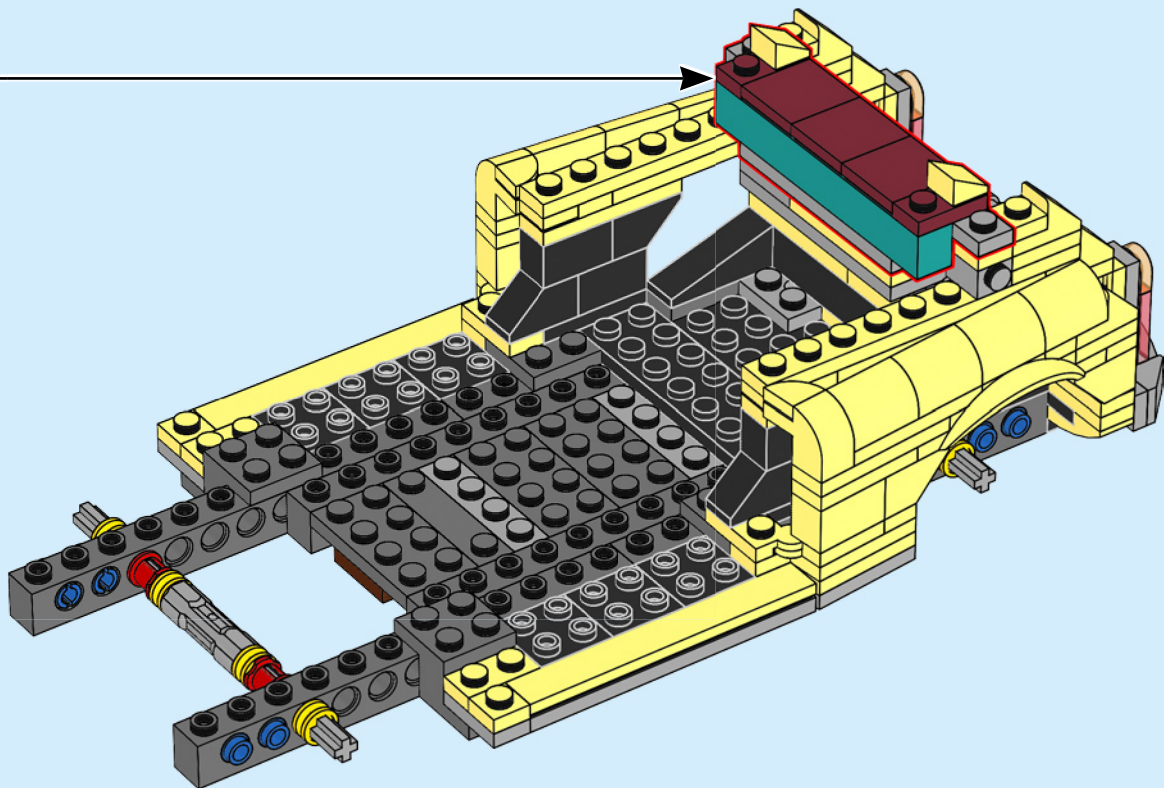

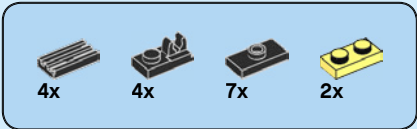

73

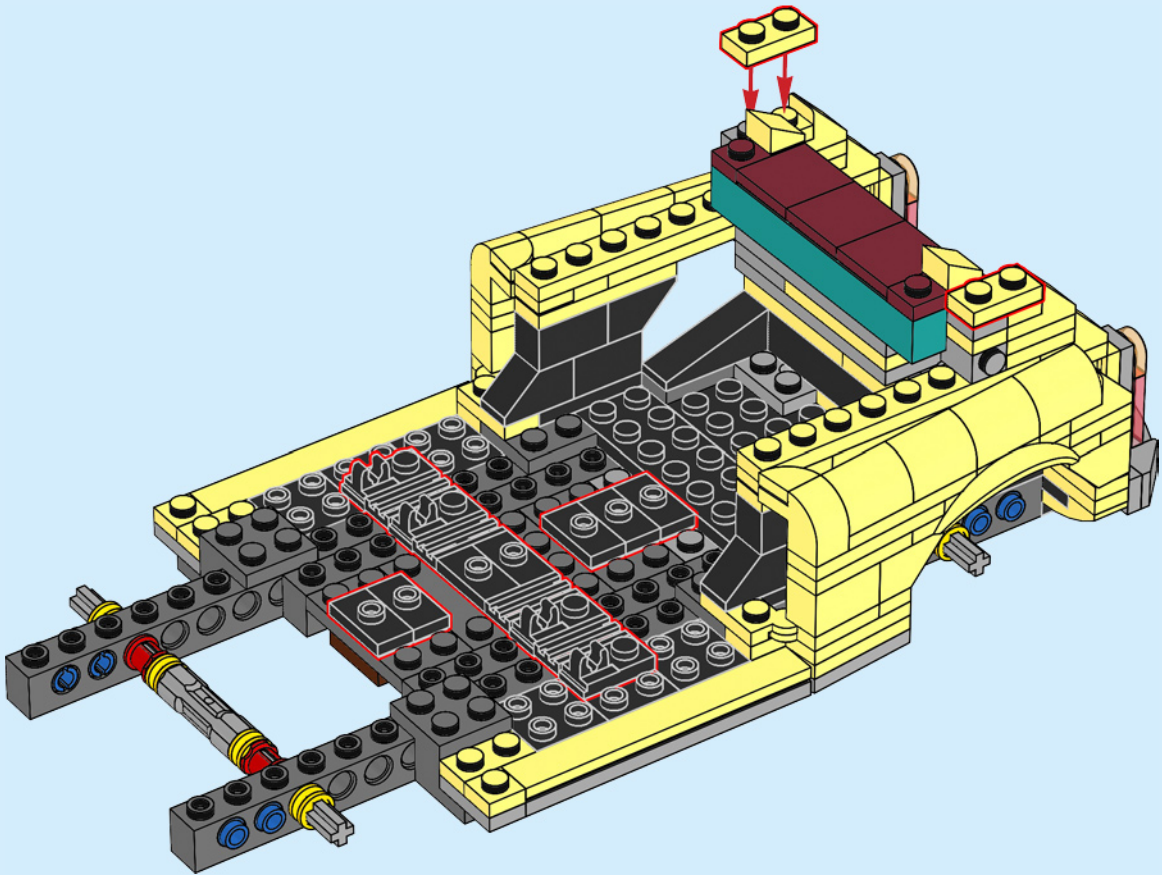

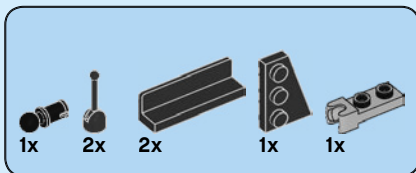

74

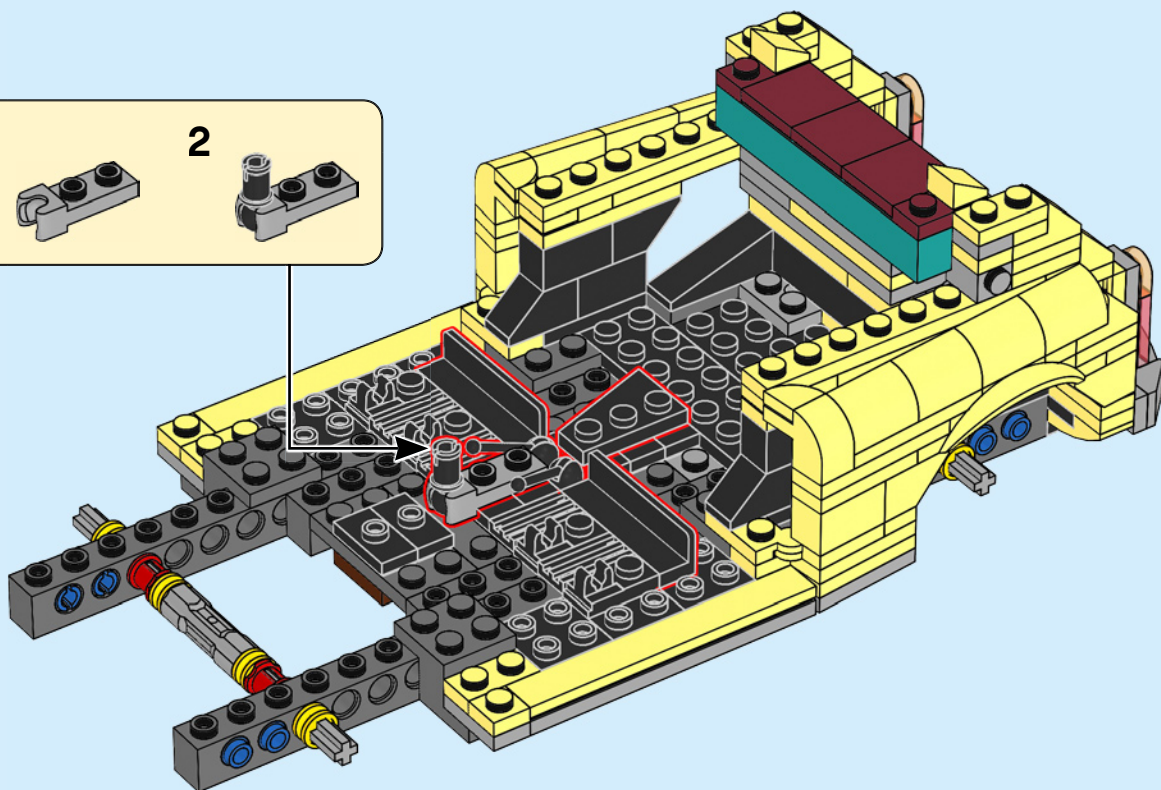
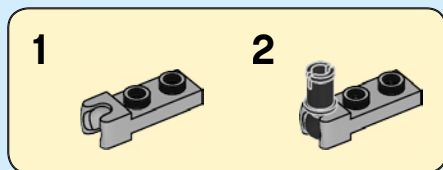

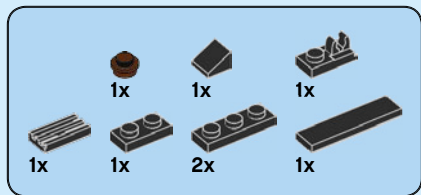

75

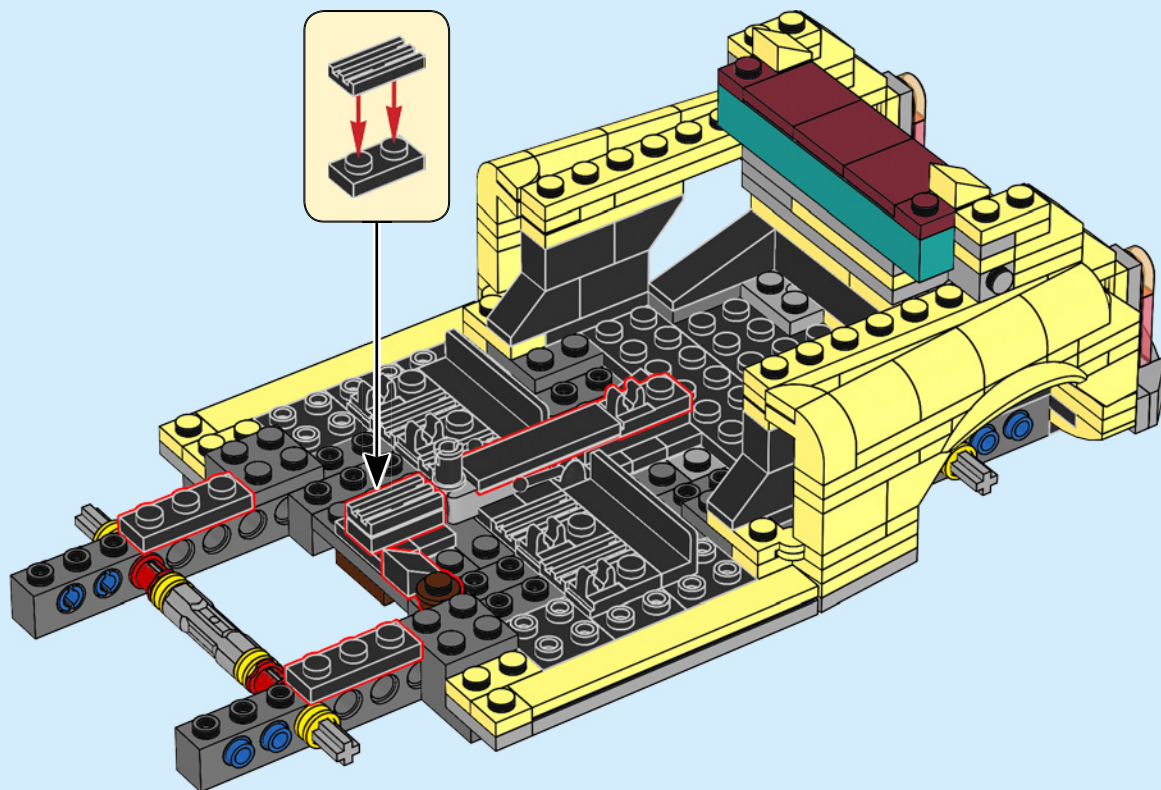

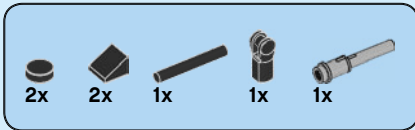

76

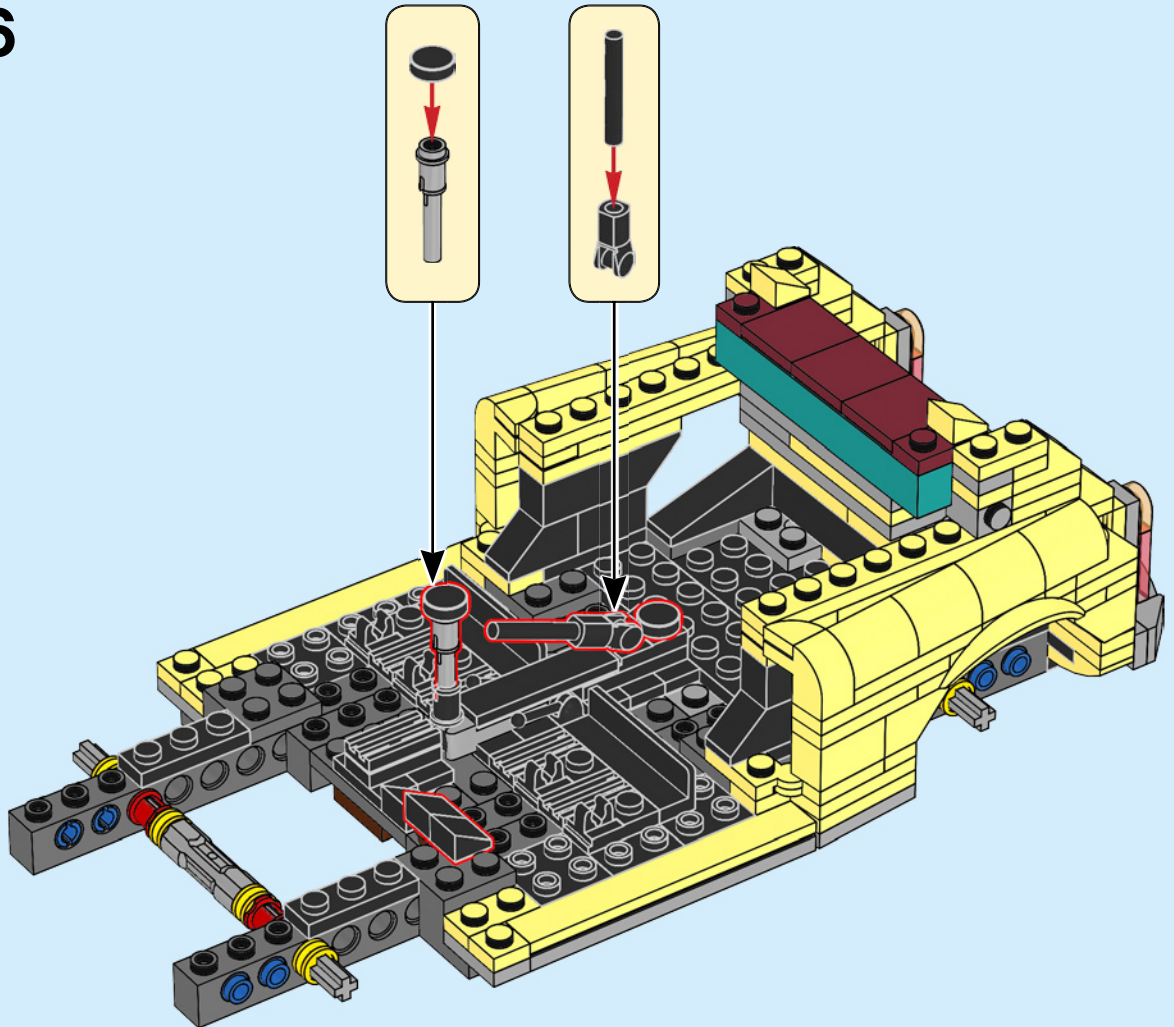

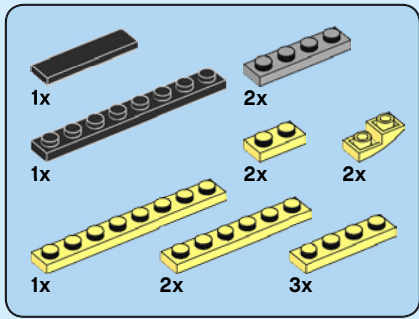

77

1

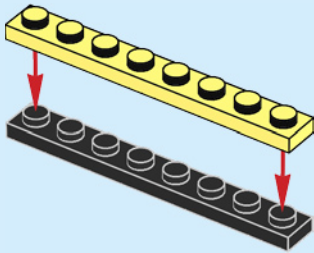

2

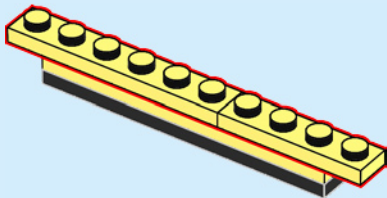

3

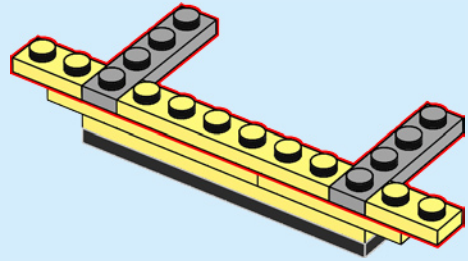

4

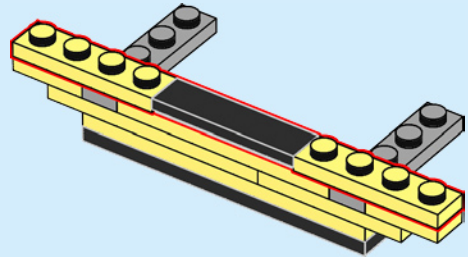

5

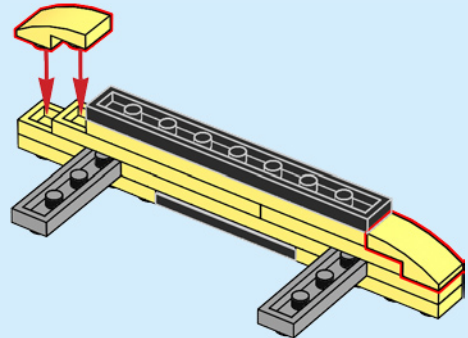
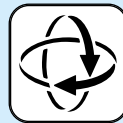

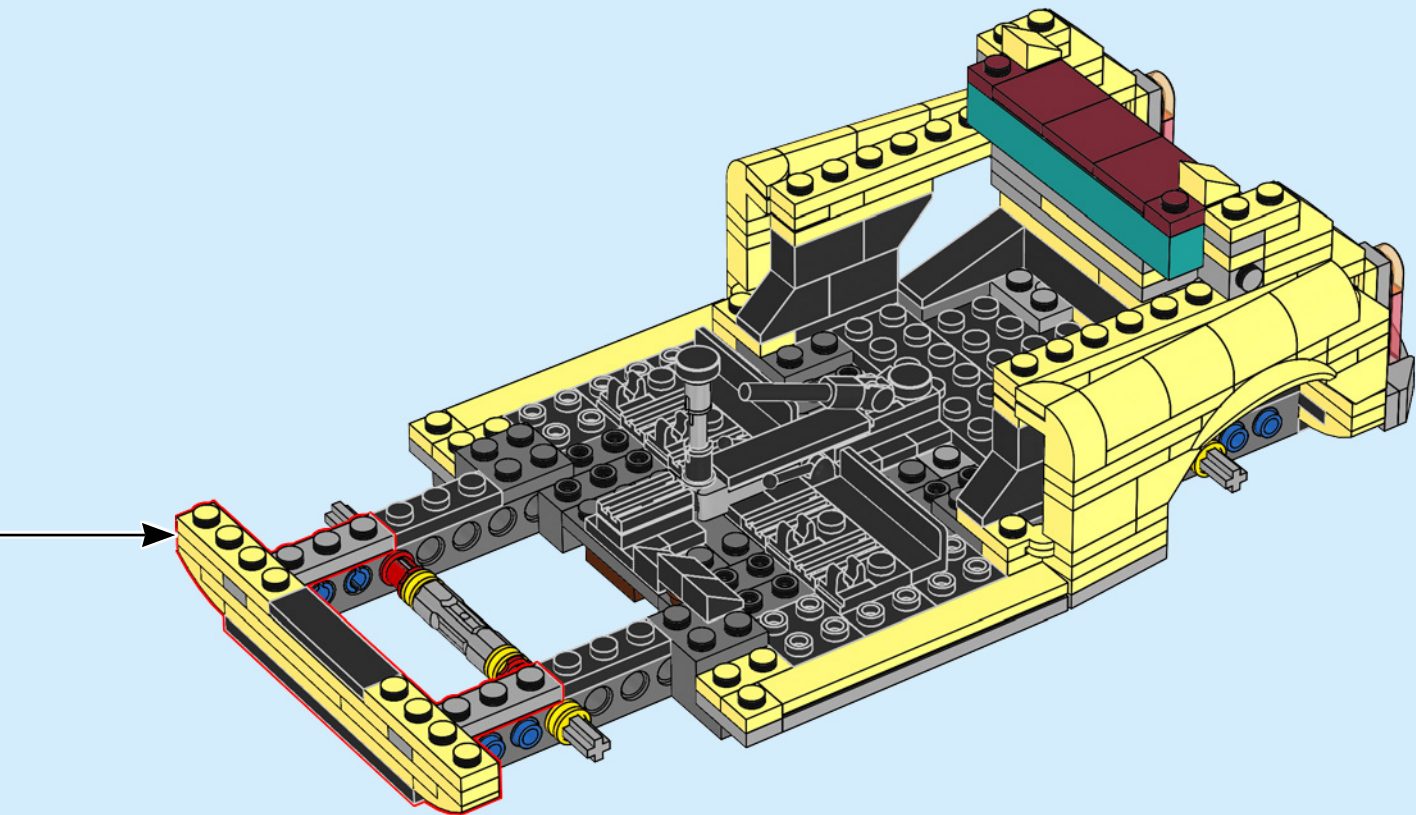

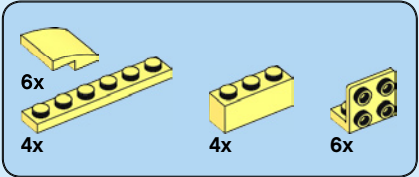
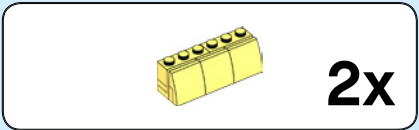
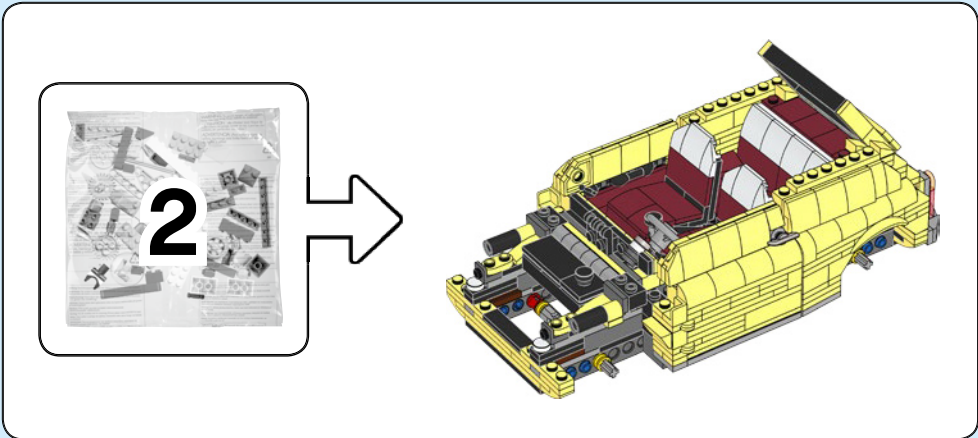

78

1

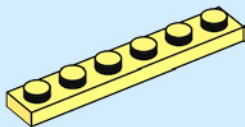

2

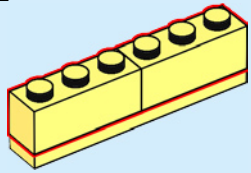

3

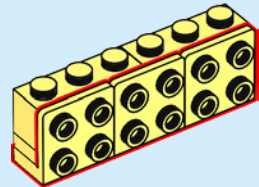

4

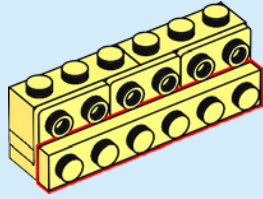

5

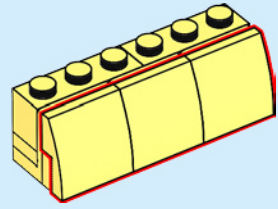

2x

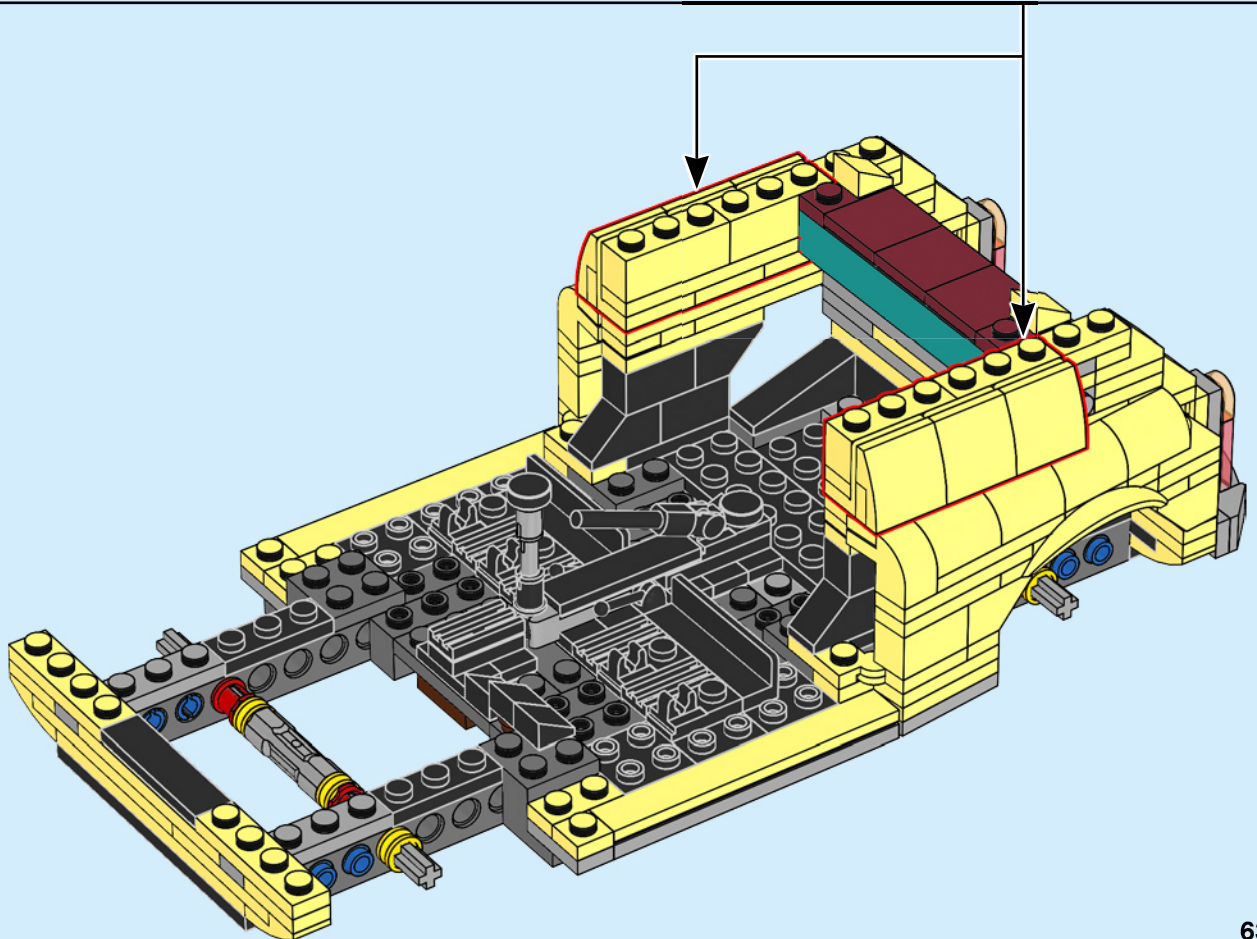

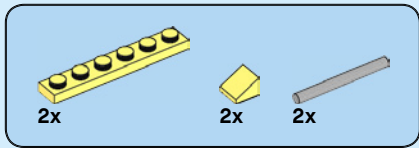

79

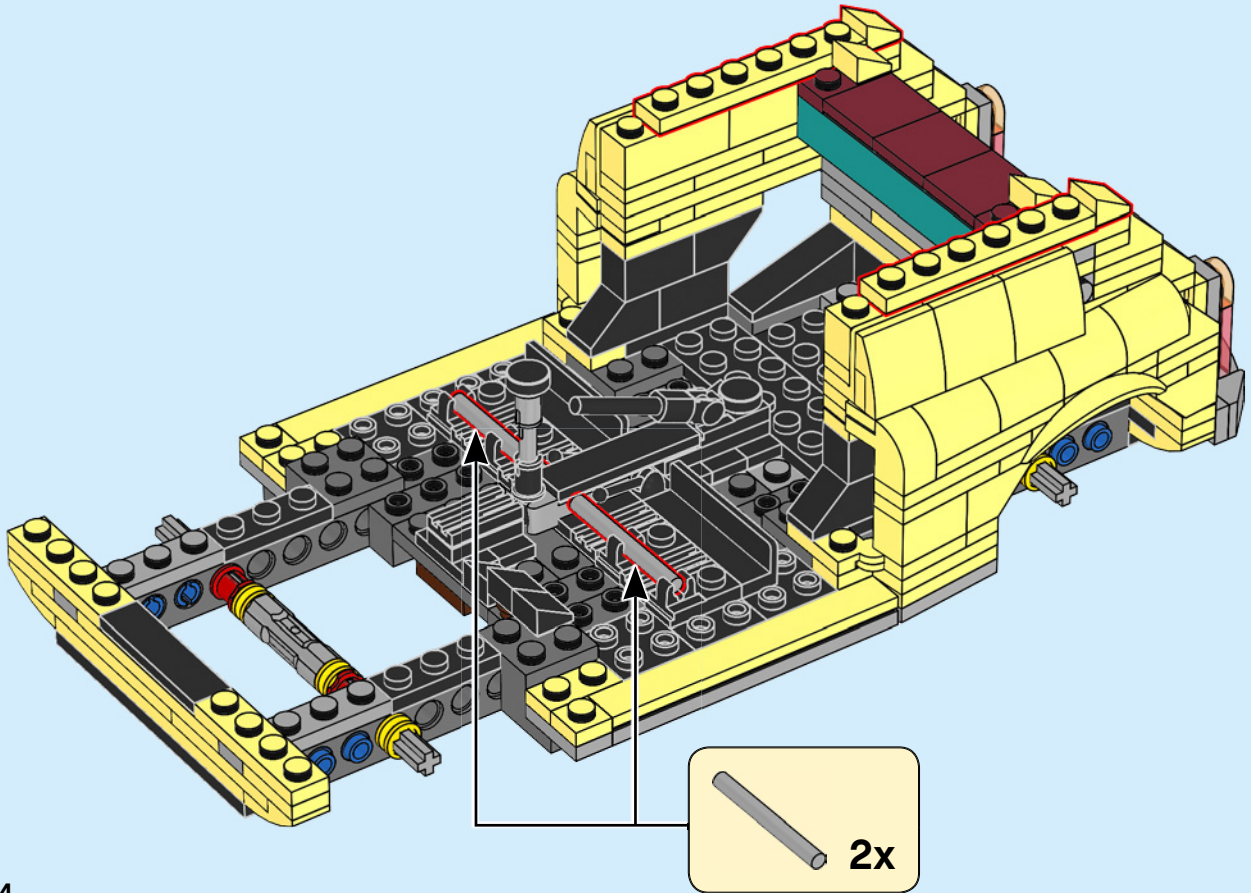

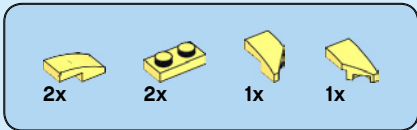

80

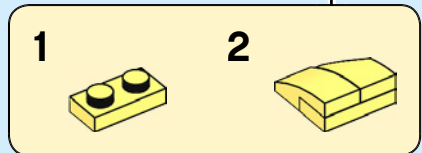
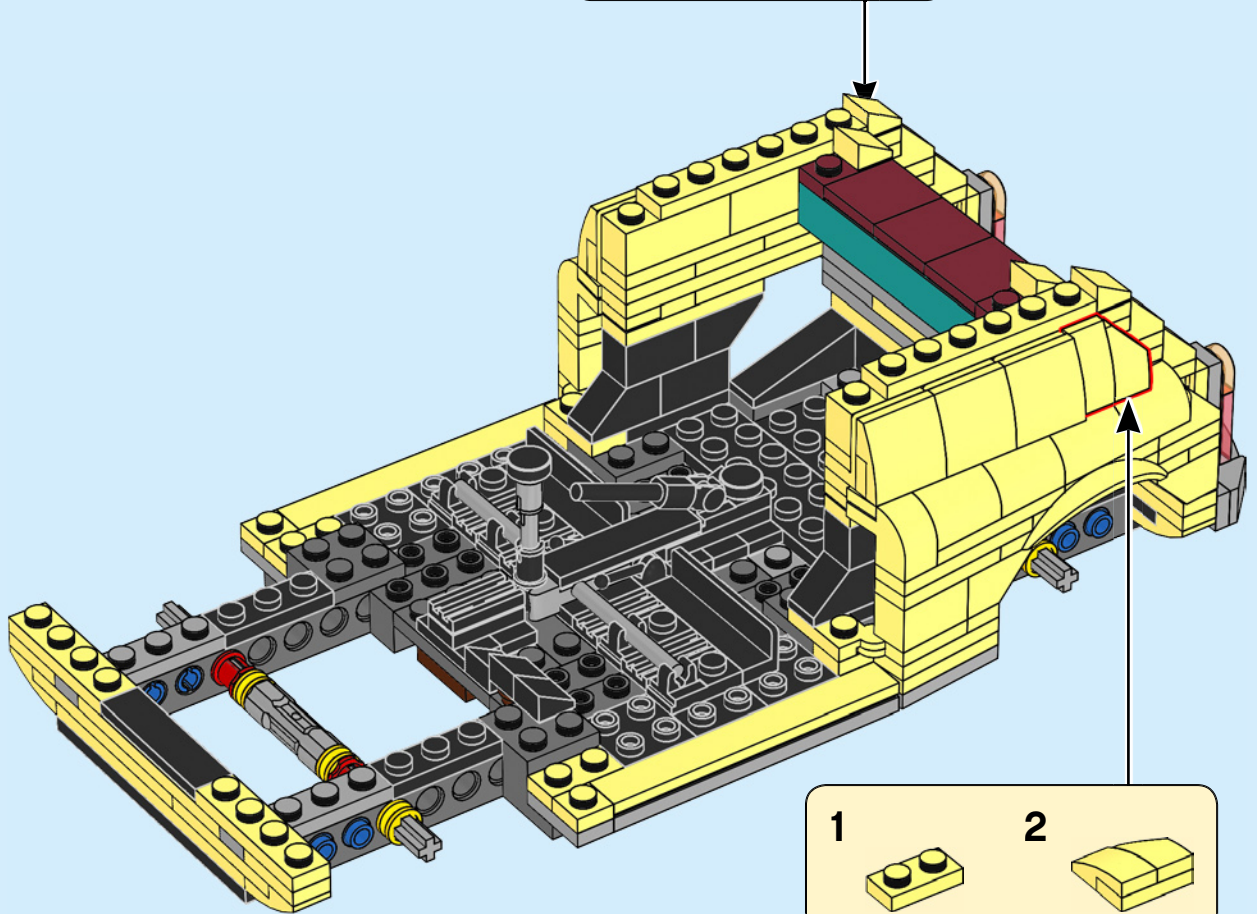
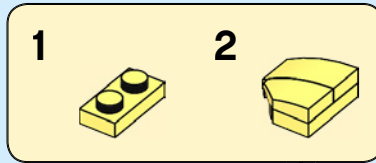

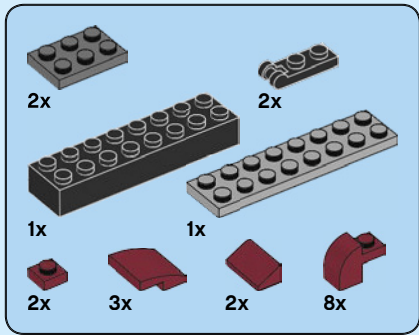

81

1

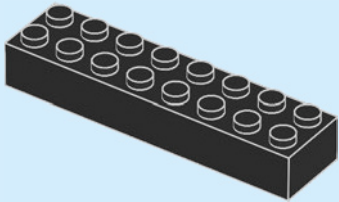

2

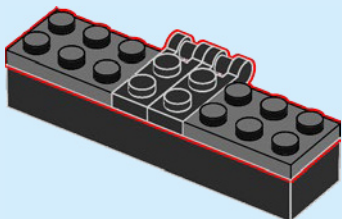

3

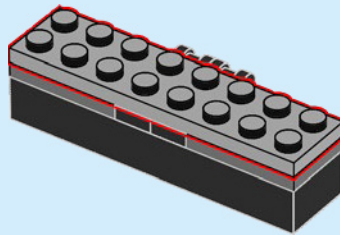

4

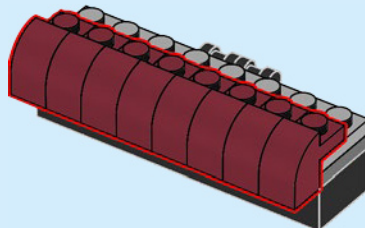

5

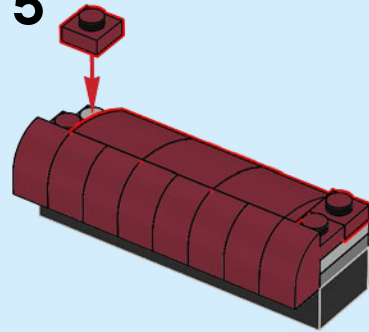

6

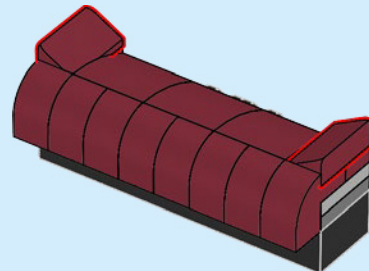

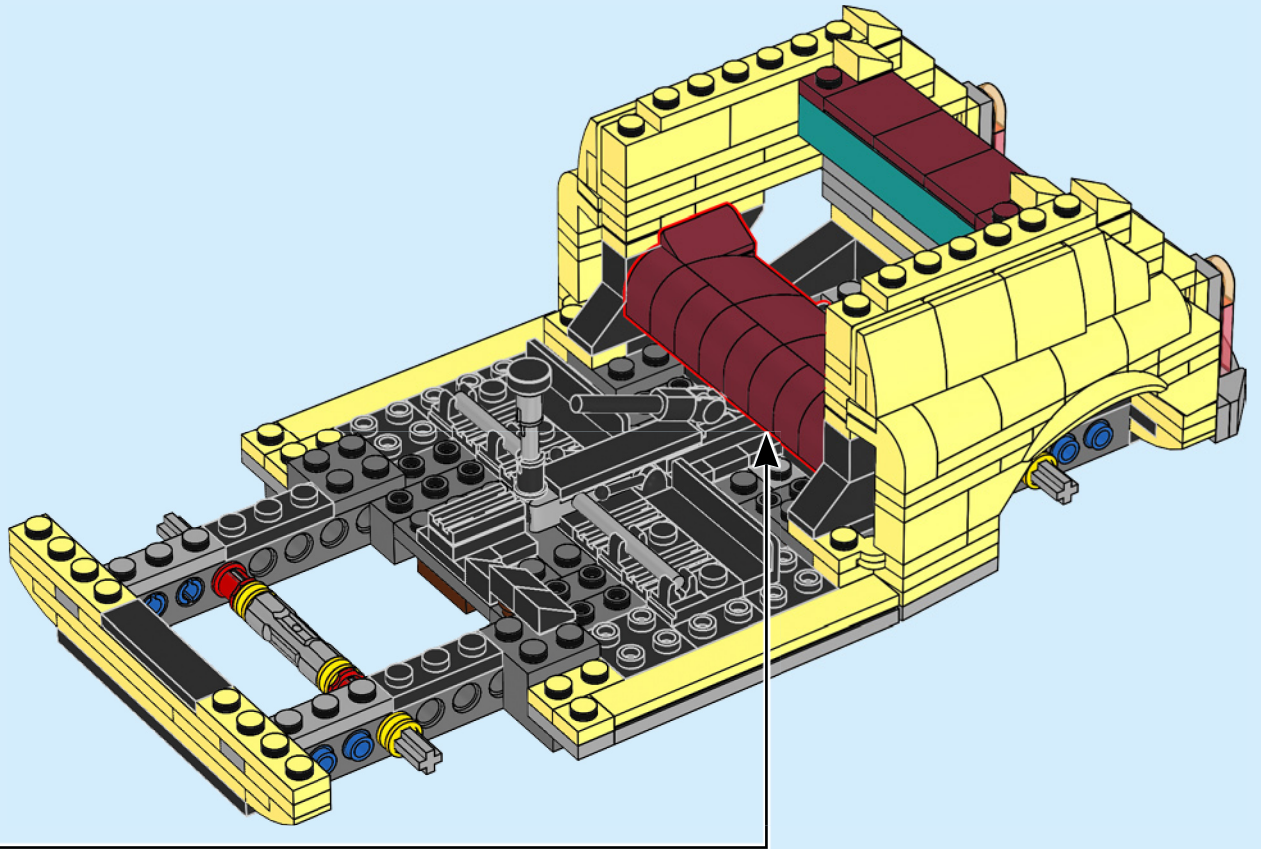

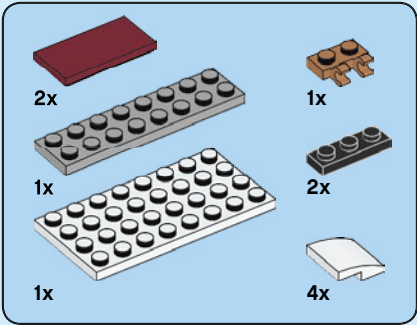

82

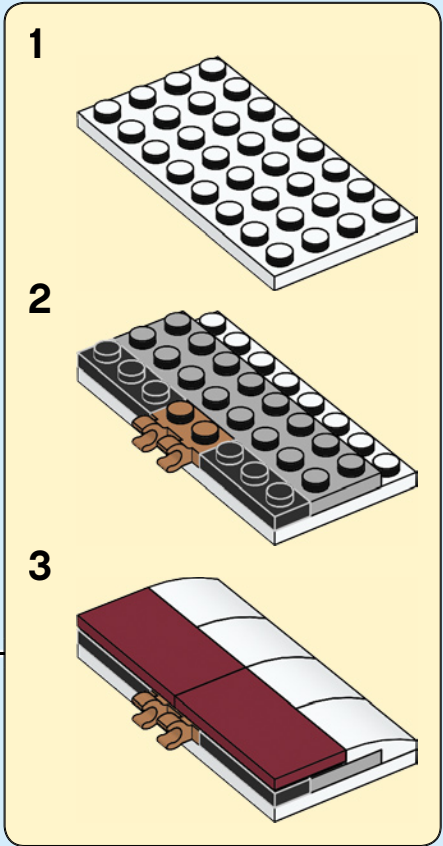
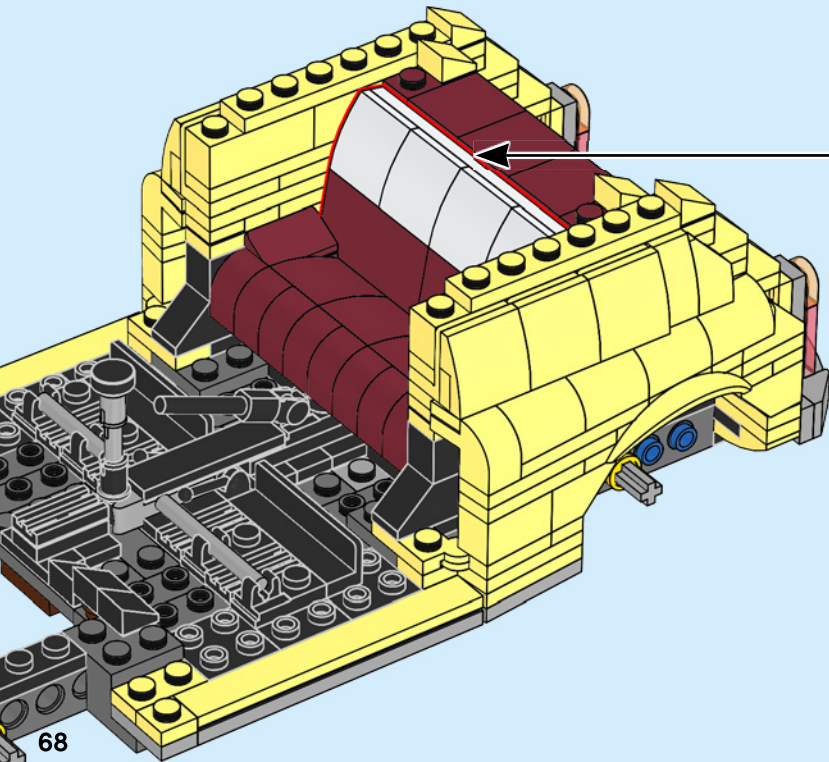

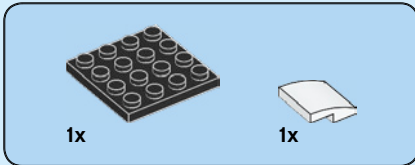

83

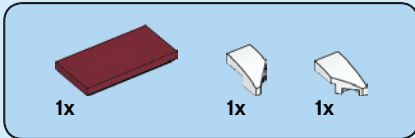
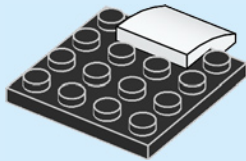

84

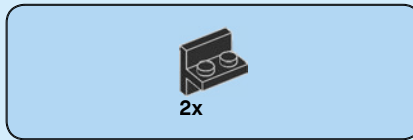
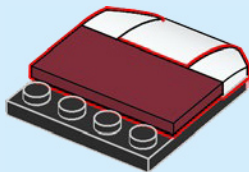

85

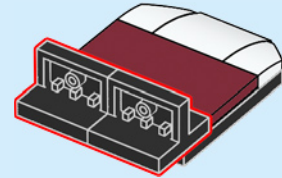

86

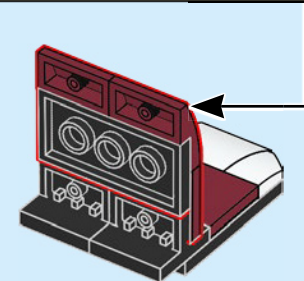
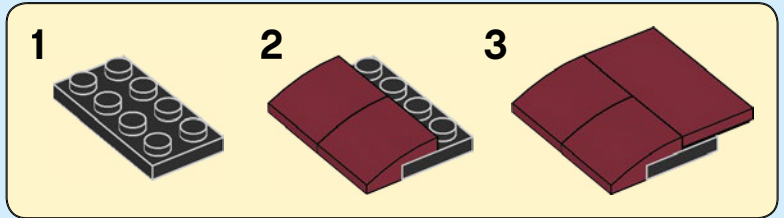



2x



1x

87

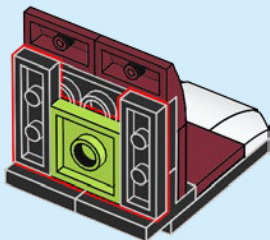

2x



2x

89

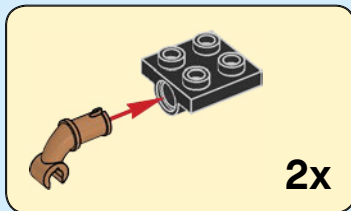

2x

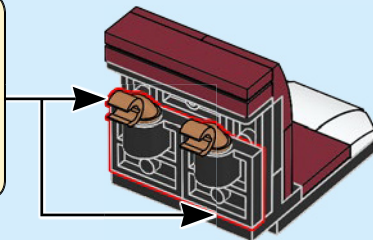

1x



1x



1x

88

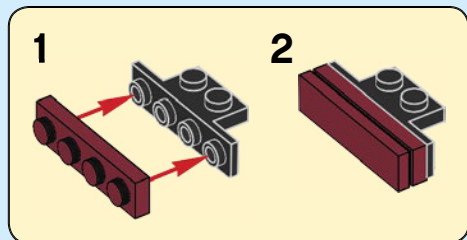

2

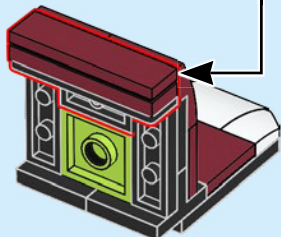

1x



1x

90

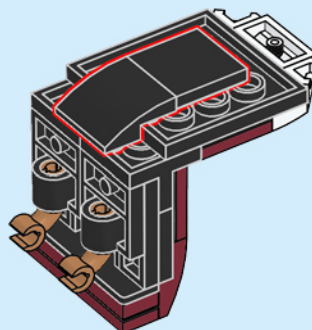

2x

91

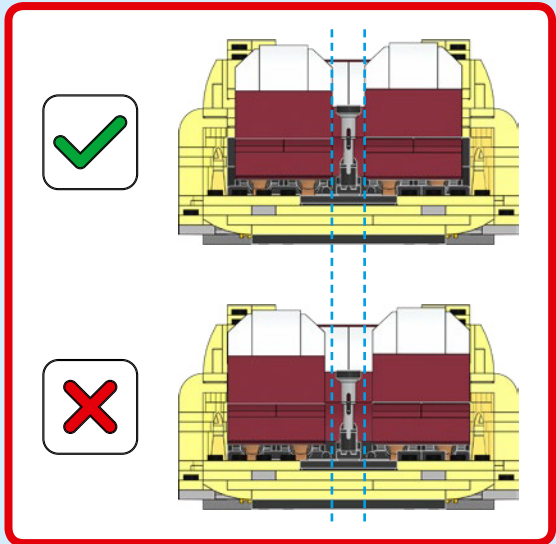
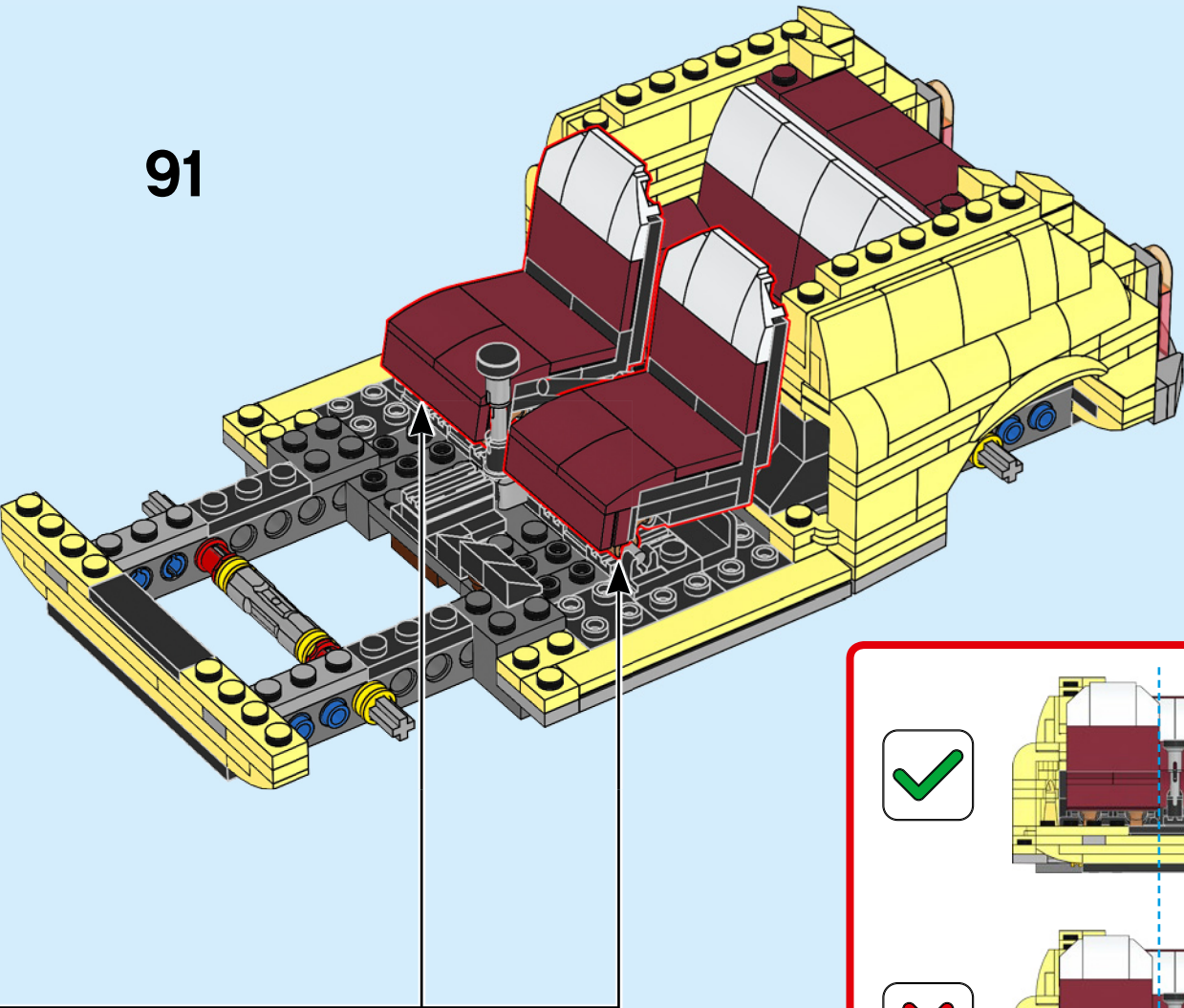

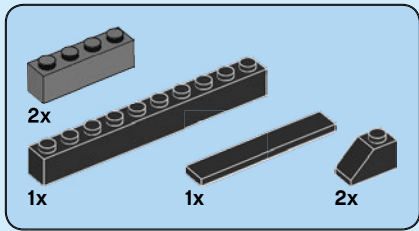

92

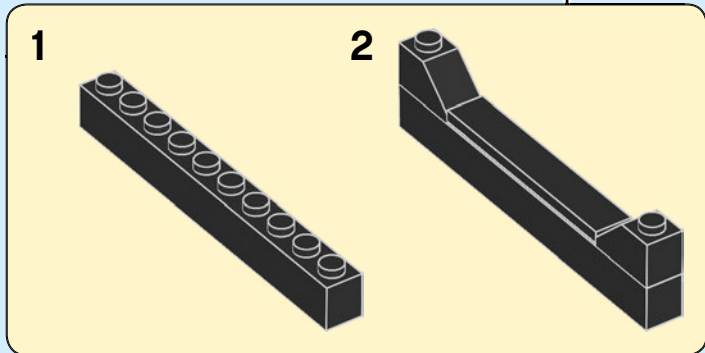
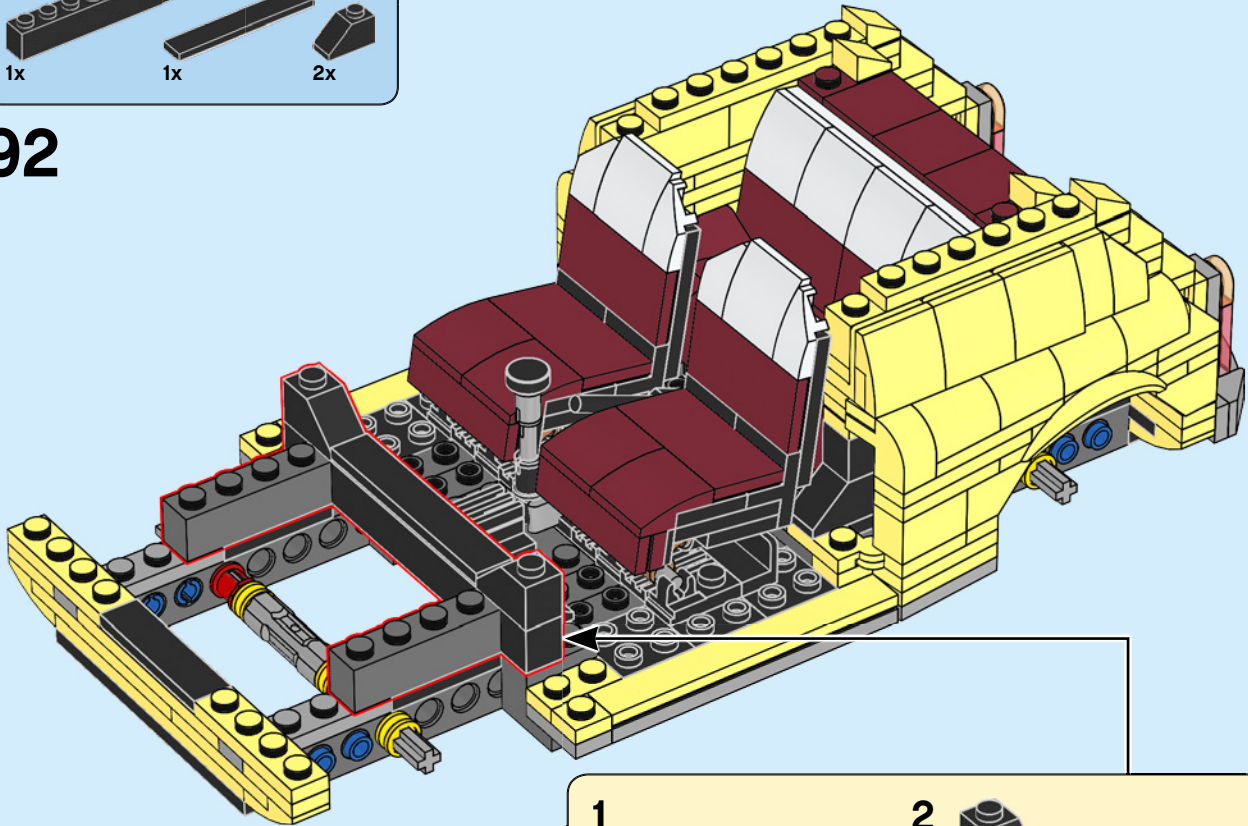

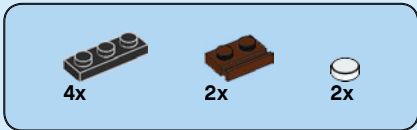

93

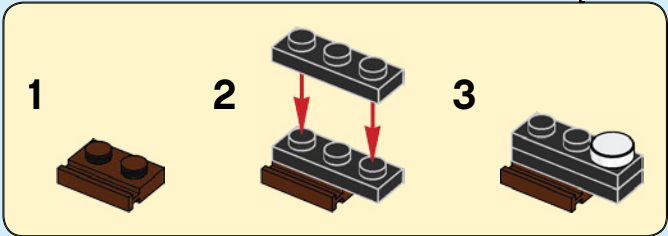
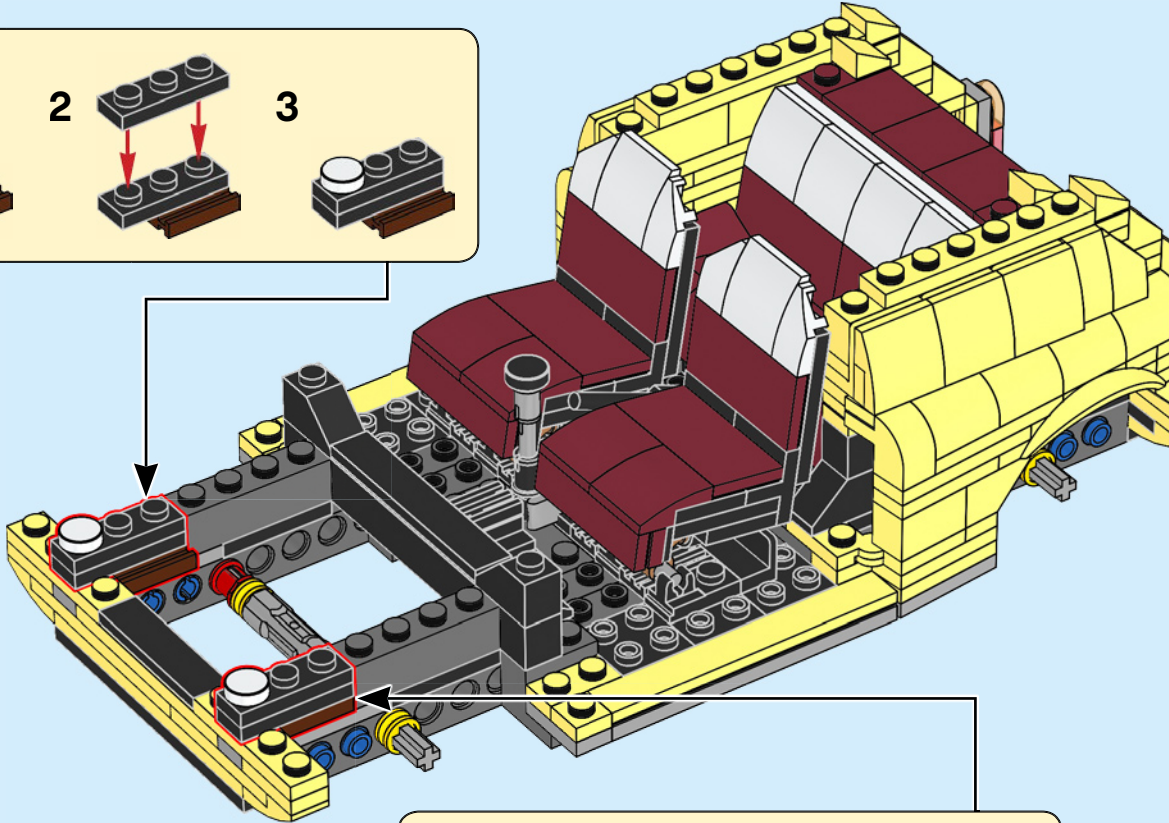
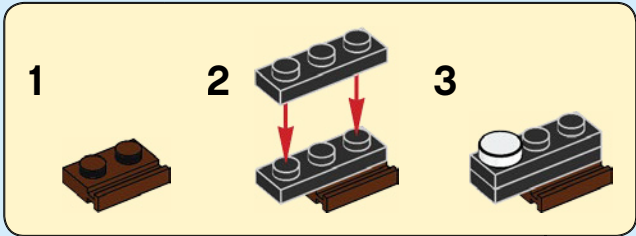

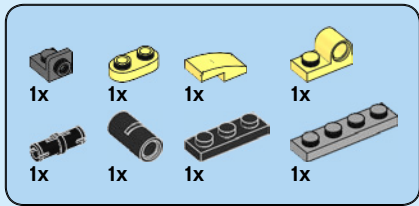

94

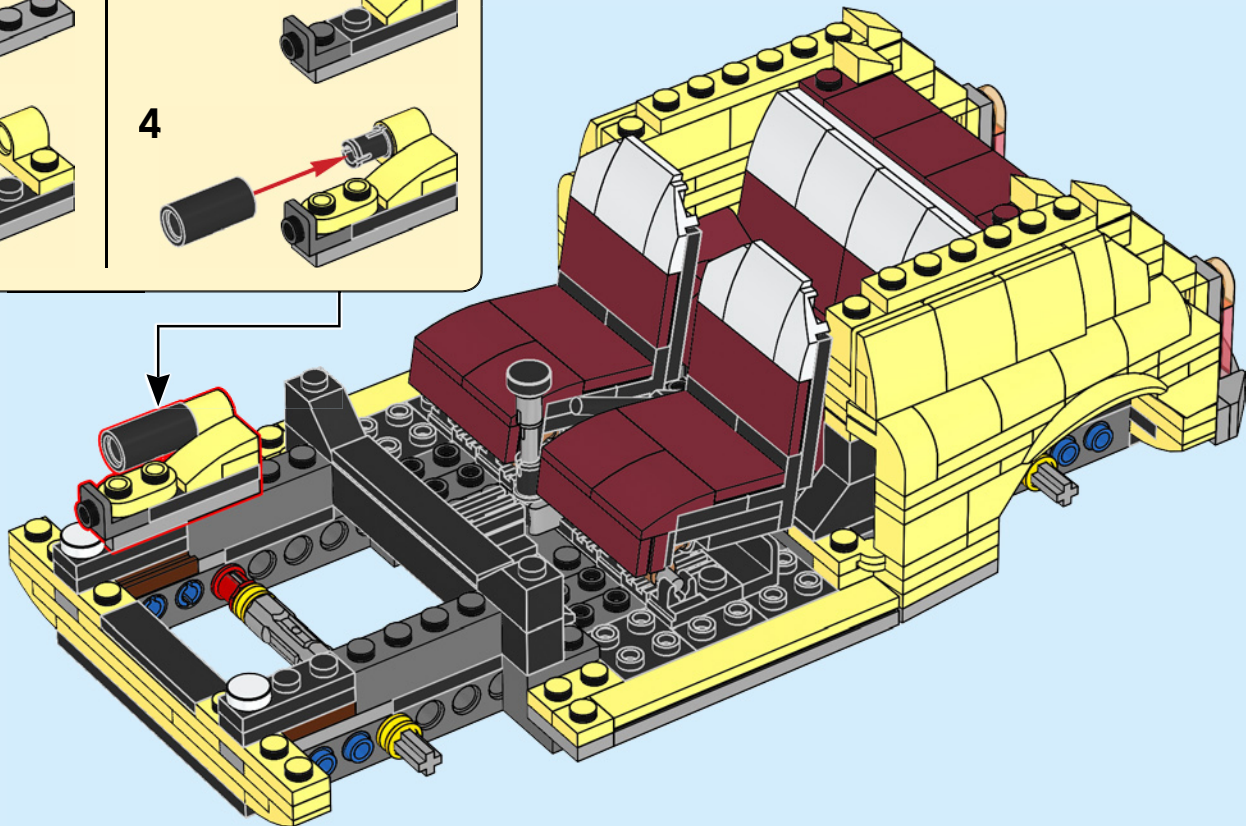
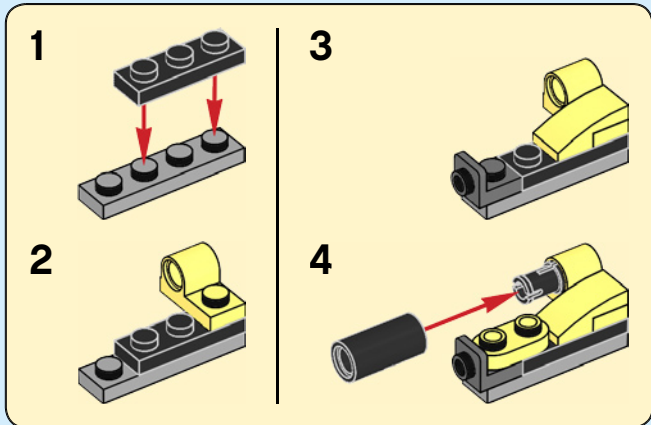

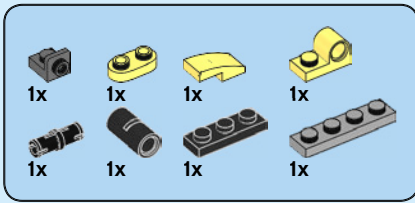

95

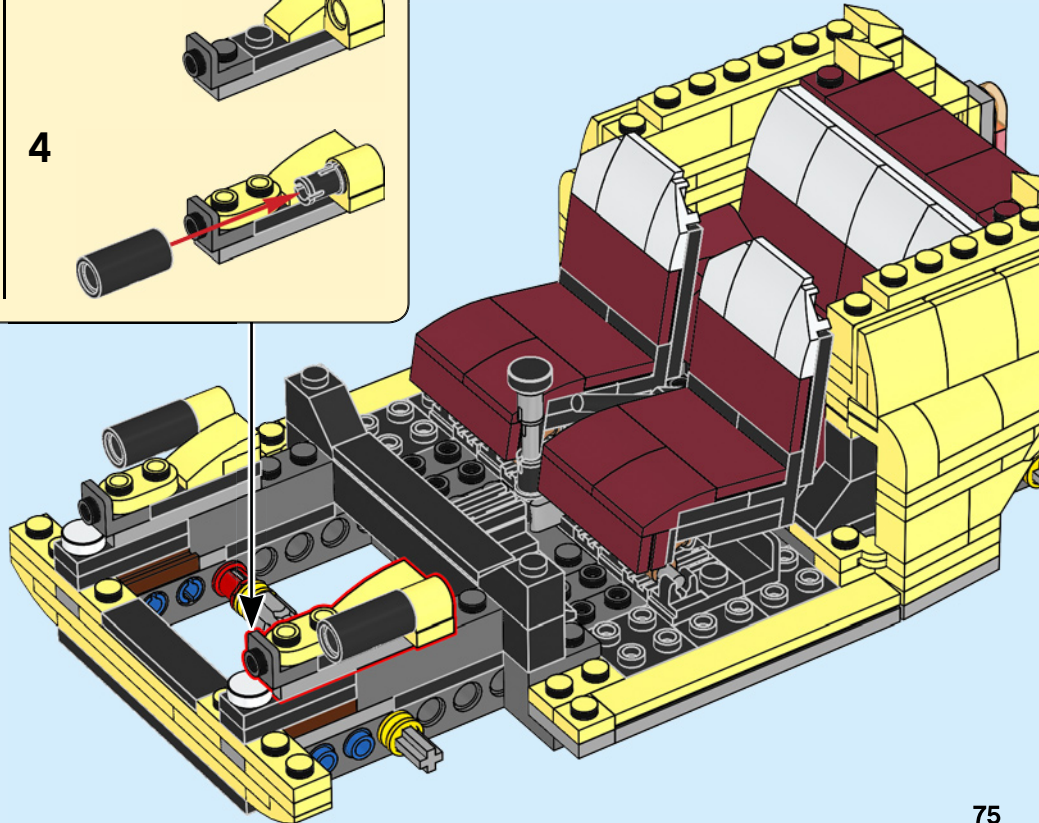
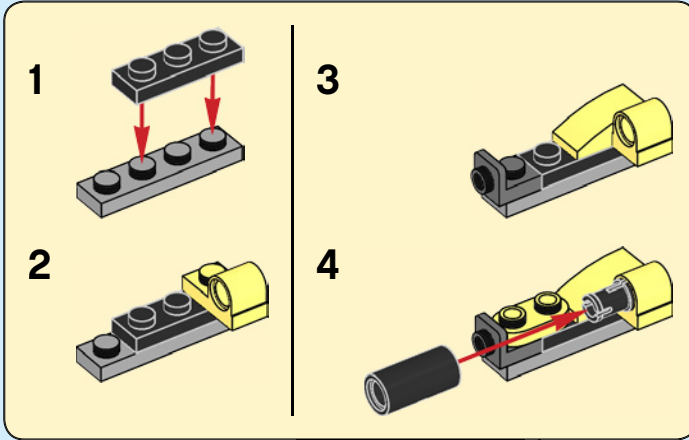

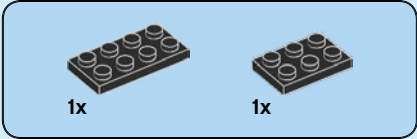
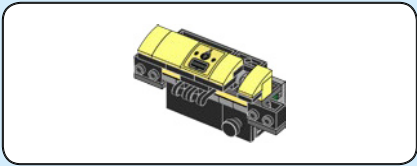

96

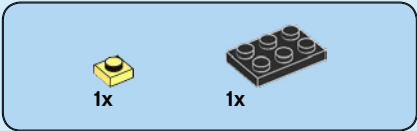
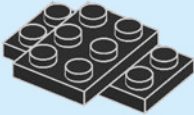

97

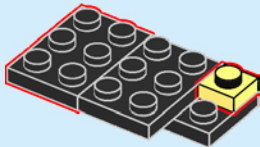

98

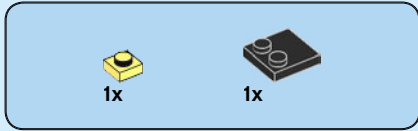
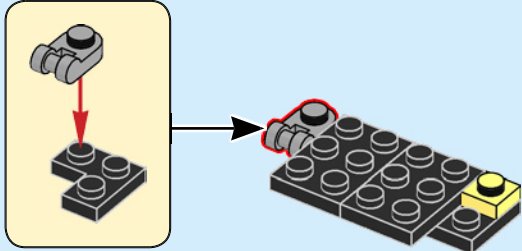

99

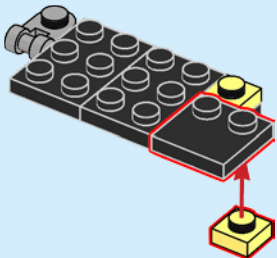

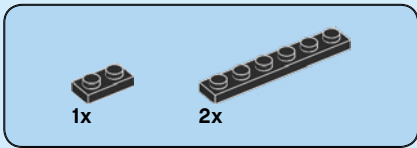

100

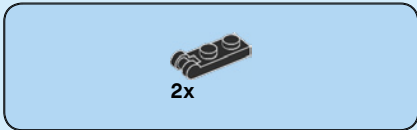
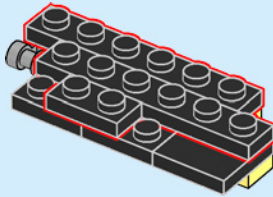

101

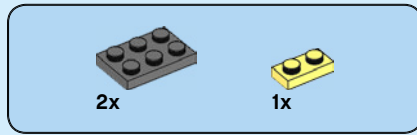
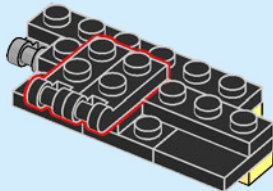

102

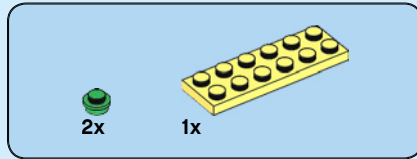
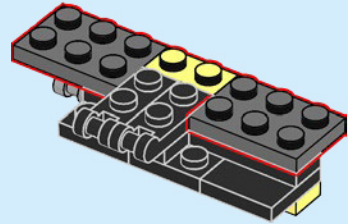

103

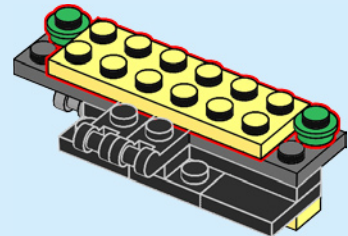

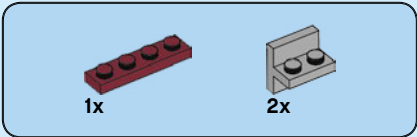

104

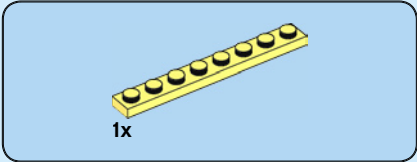
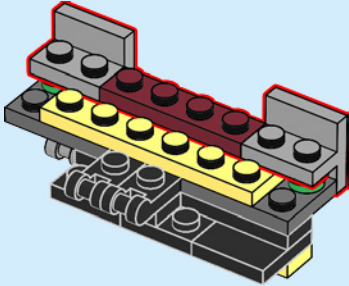

105

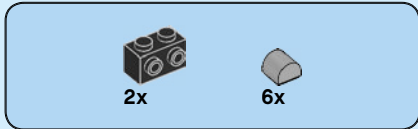
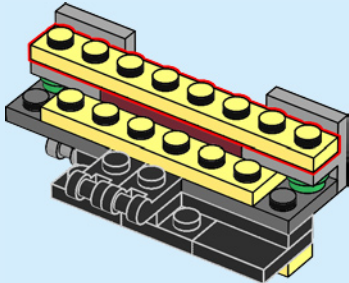

106

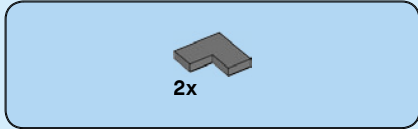
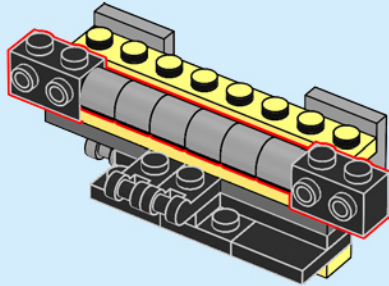

107

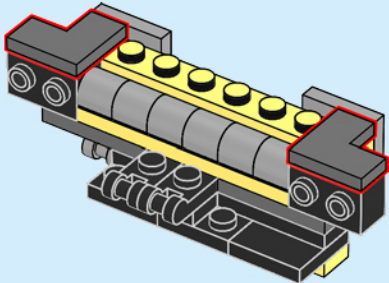

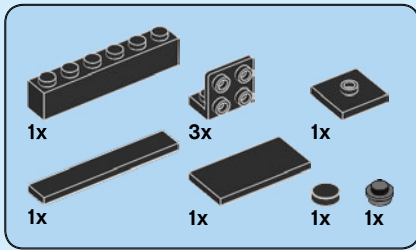

108

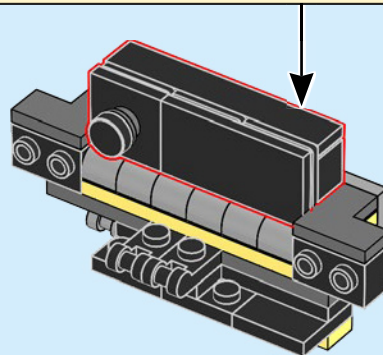
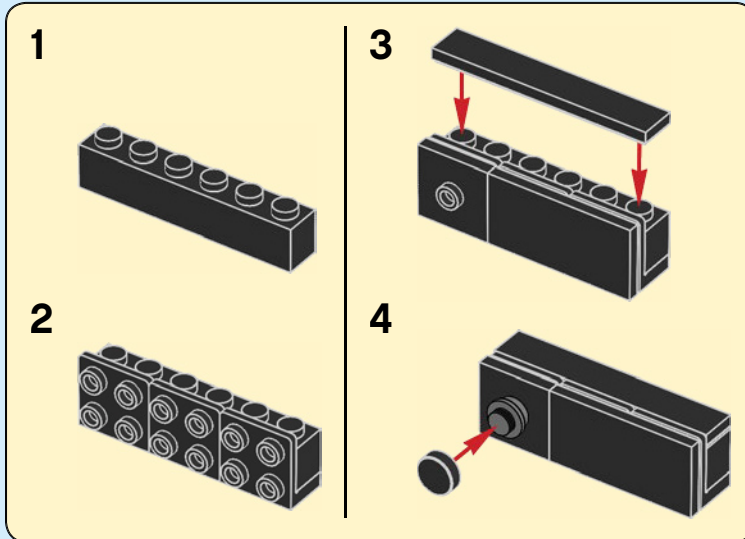

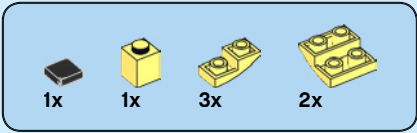

109

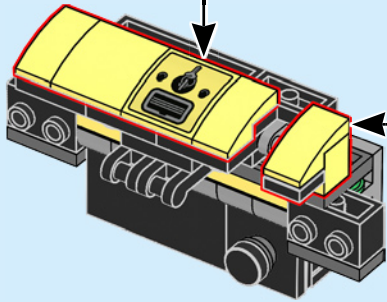
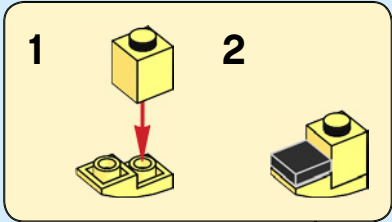
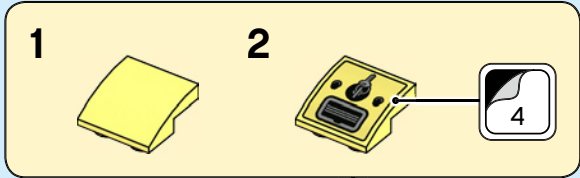

110

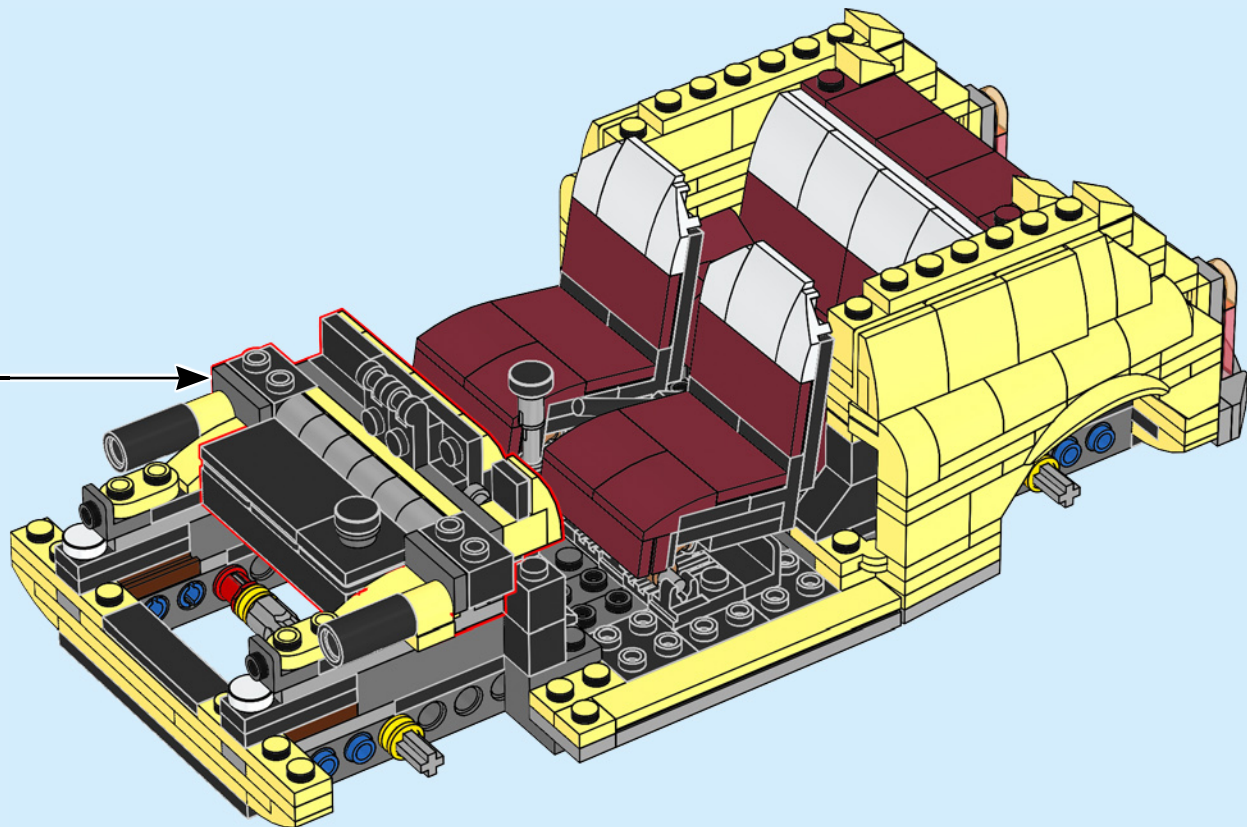

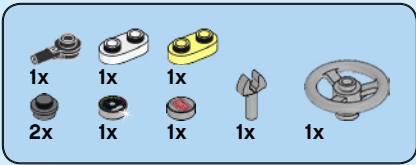

111

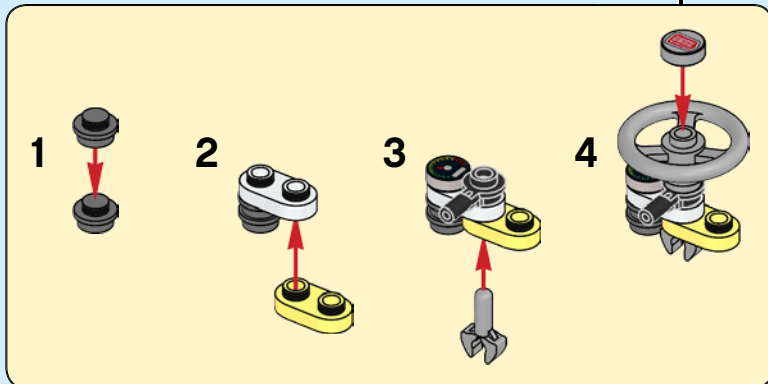
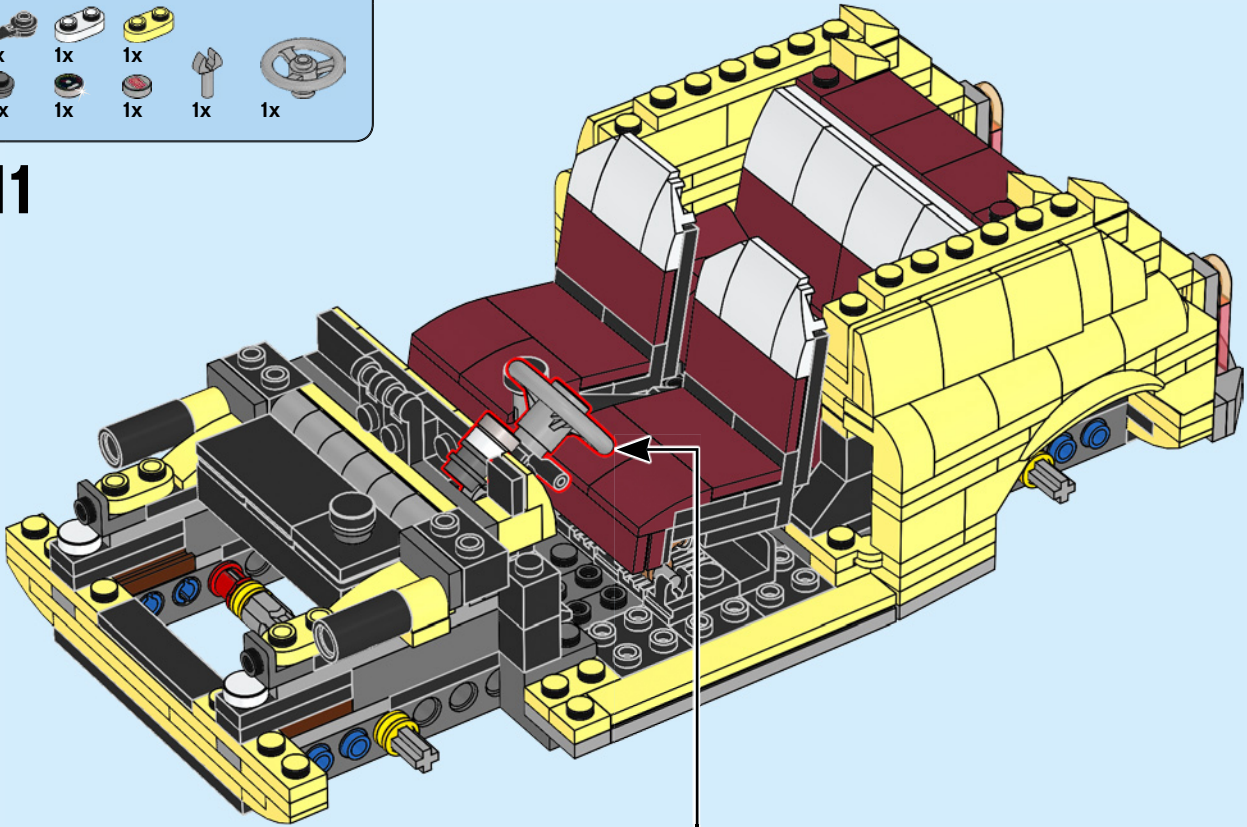

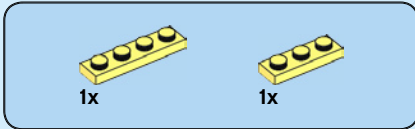
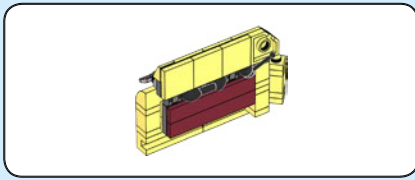

112

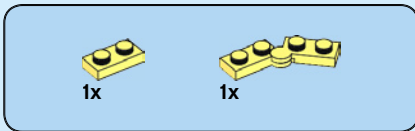
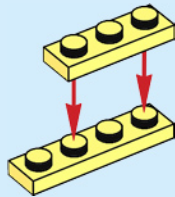

113

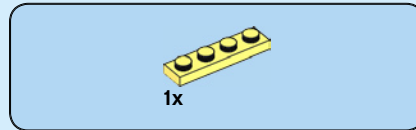
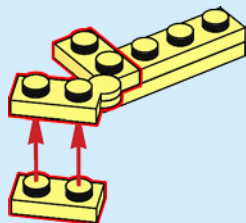

114

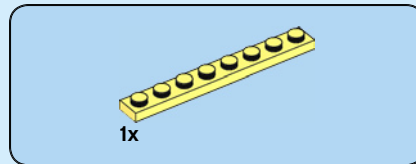
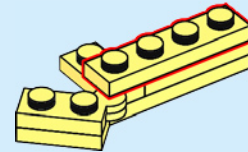

115

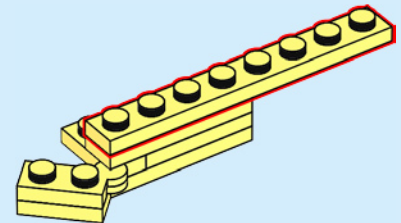

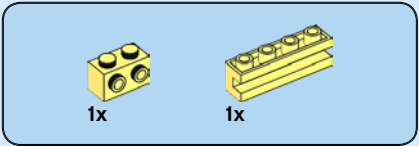

116

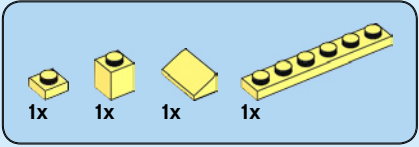
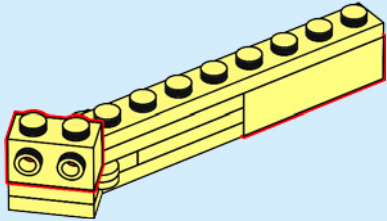

117

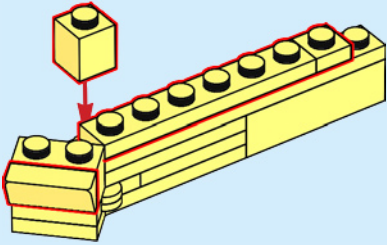

118

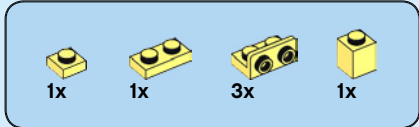
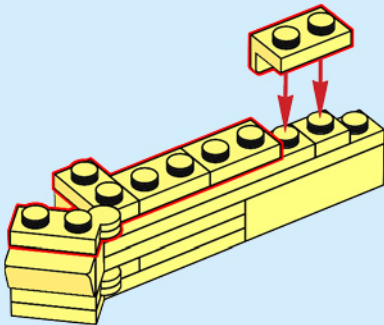

119

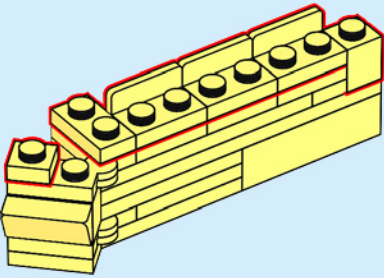

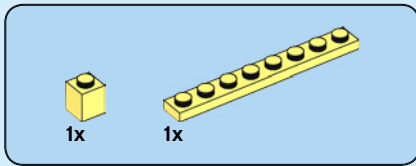

120

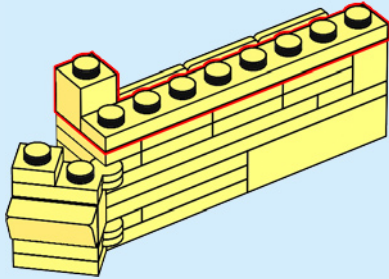

121

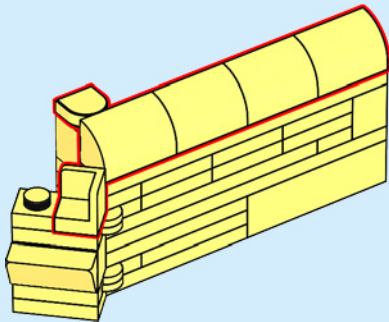

122

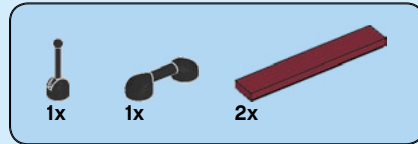
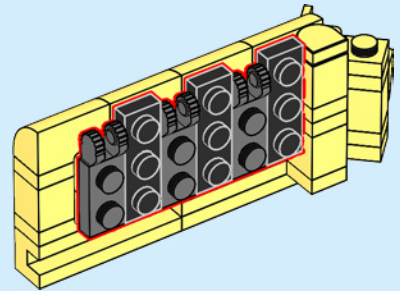
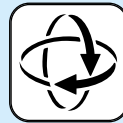

123

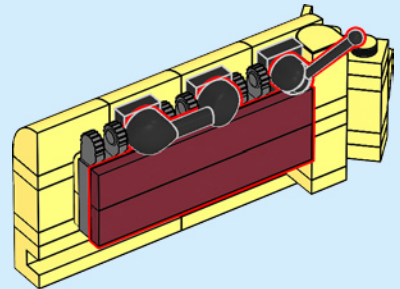

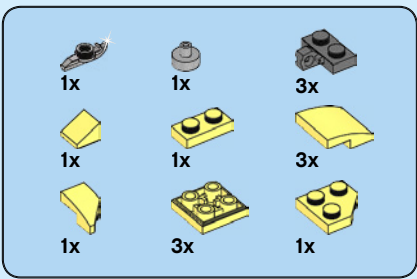

124

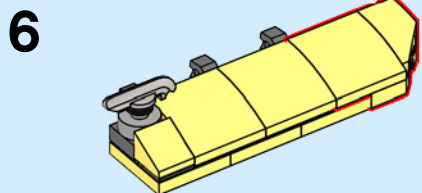
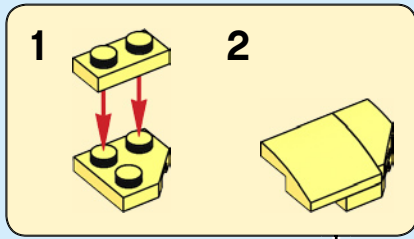
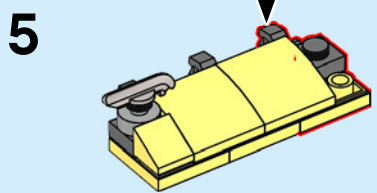
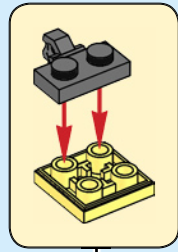
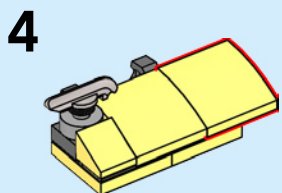
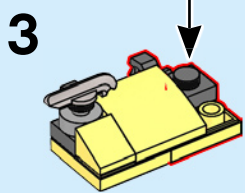
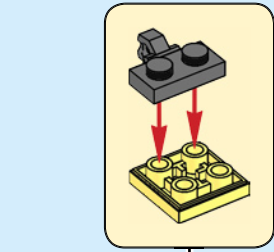
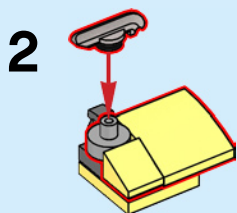
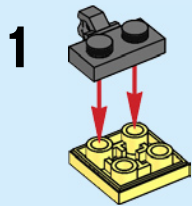

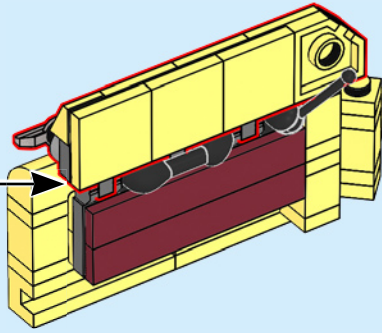

125

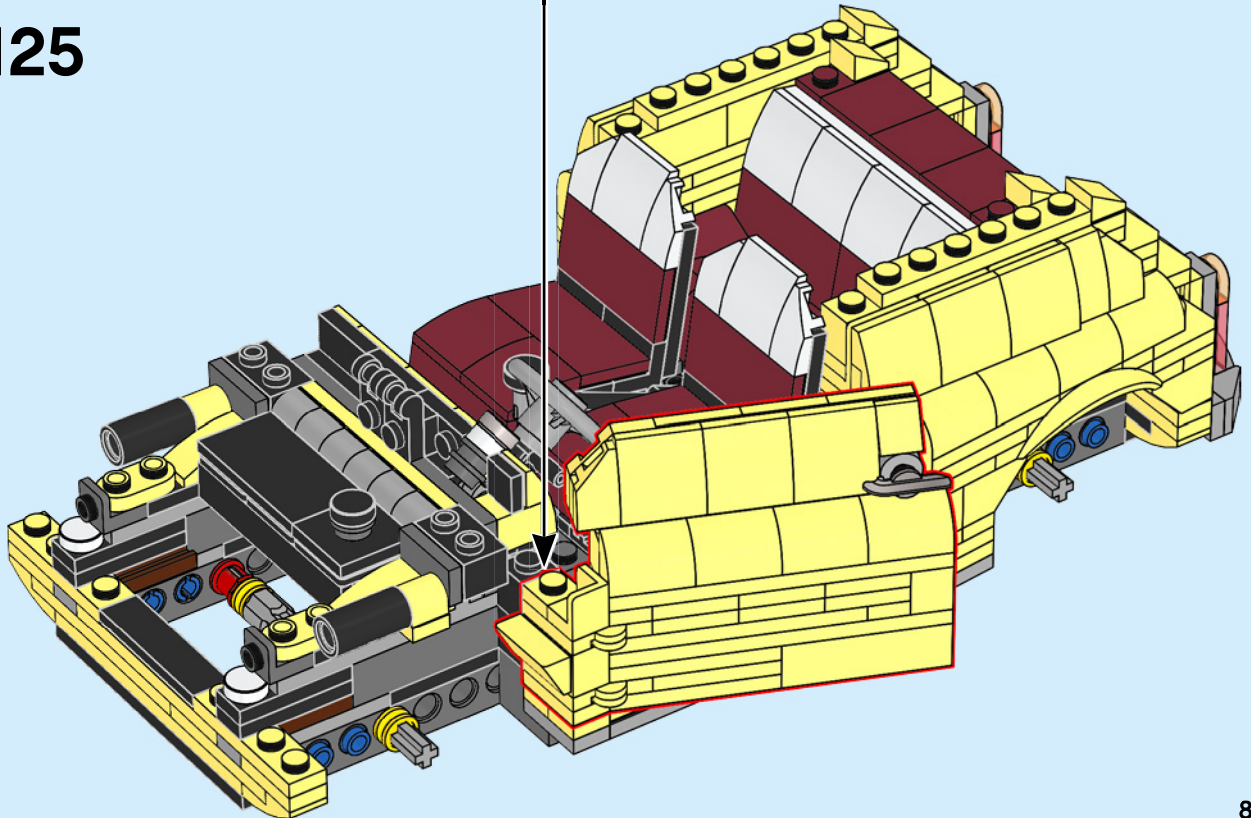

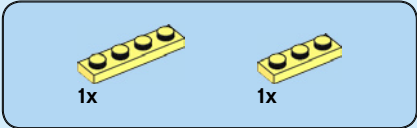
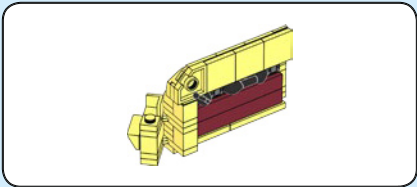

126

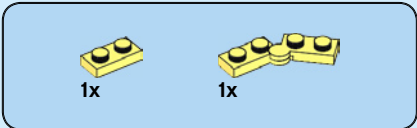
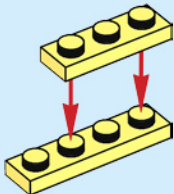

127

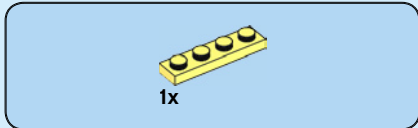
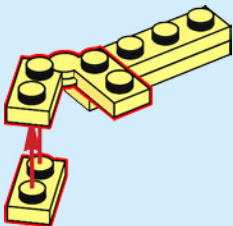

128

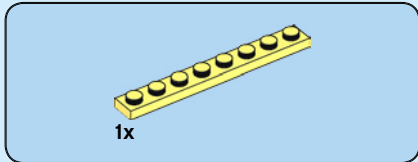
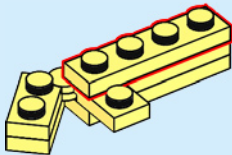

129

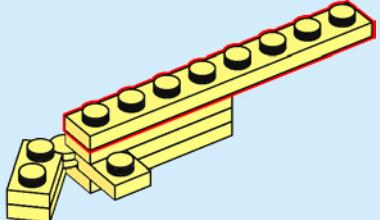

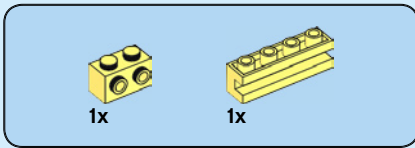

130

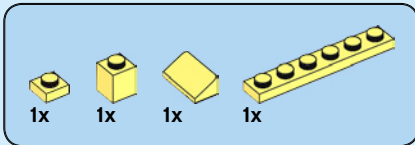
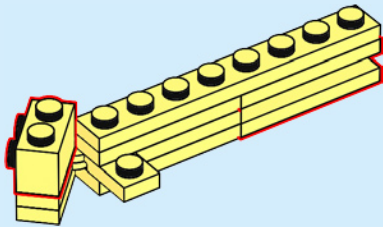

131

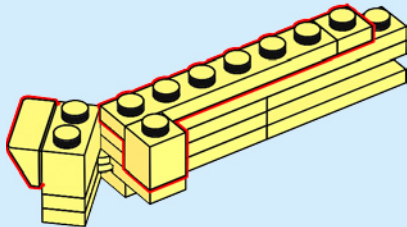

132

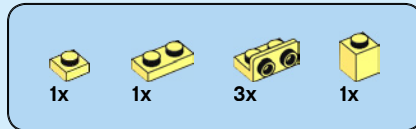
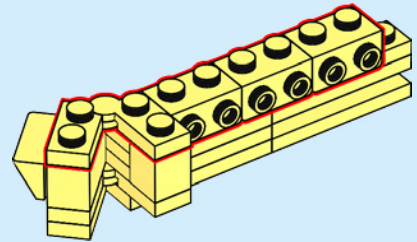

133

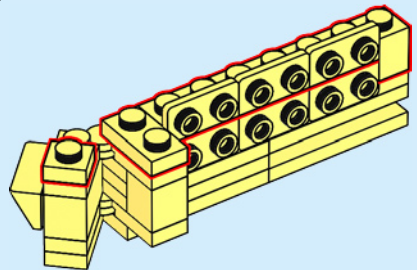

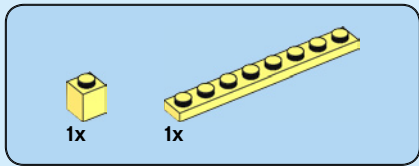

134

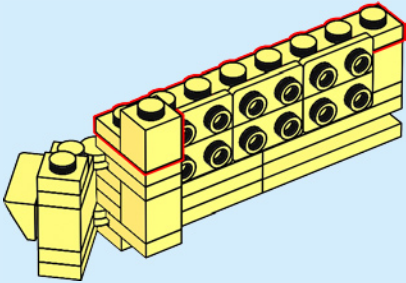

135

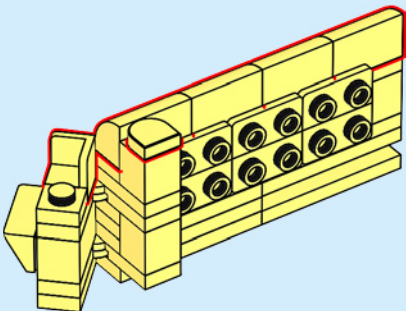

136

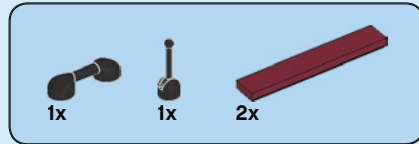
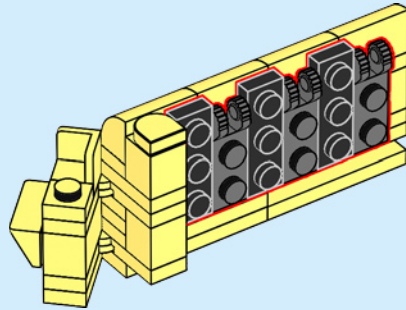

137

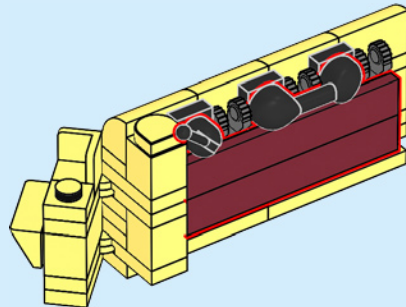

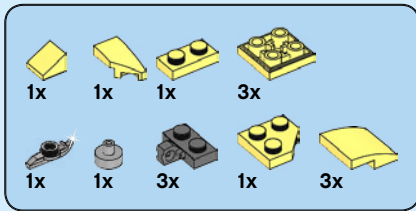

138

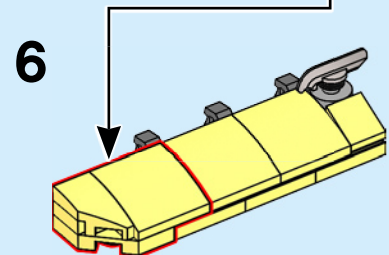
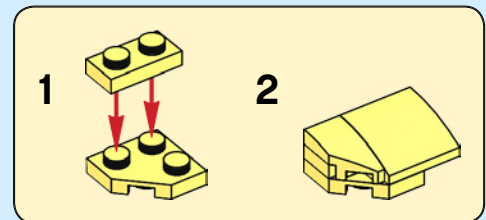
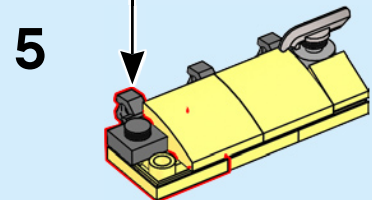
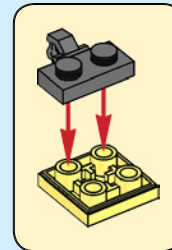
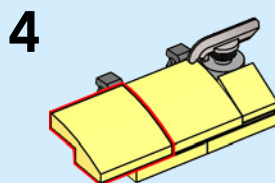
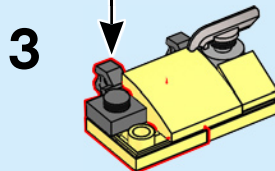
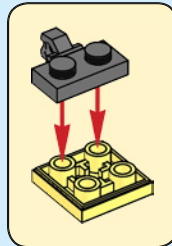
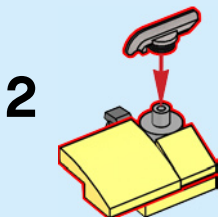
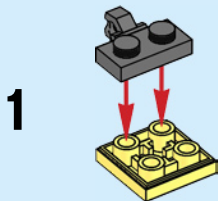

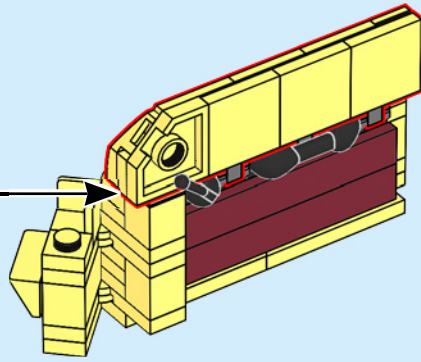

139

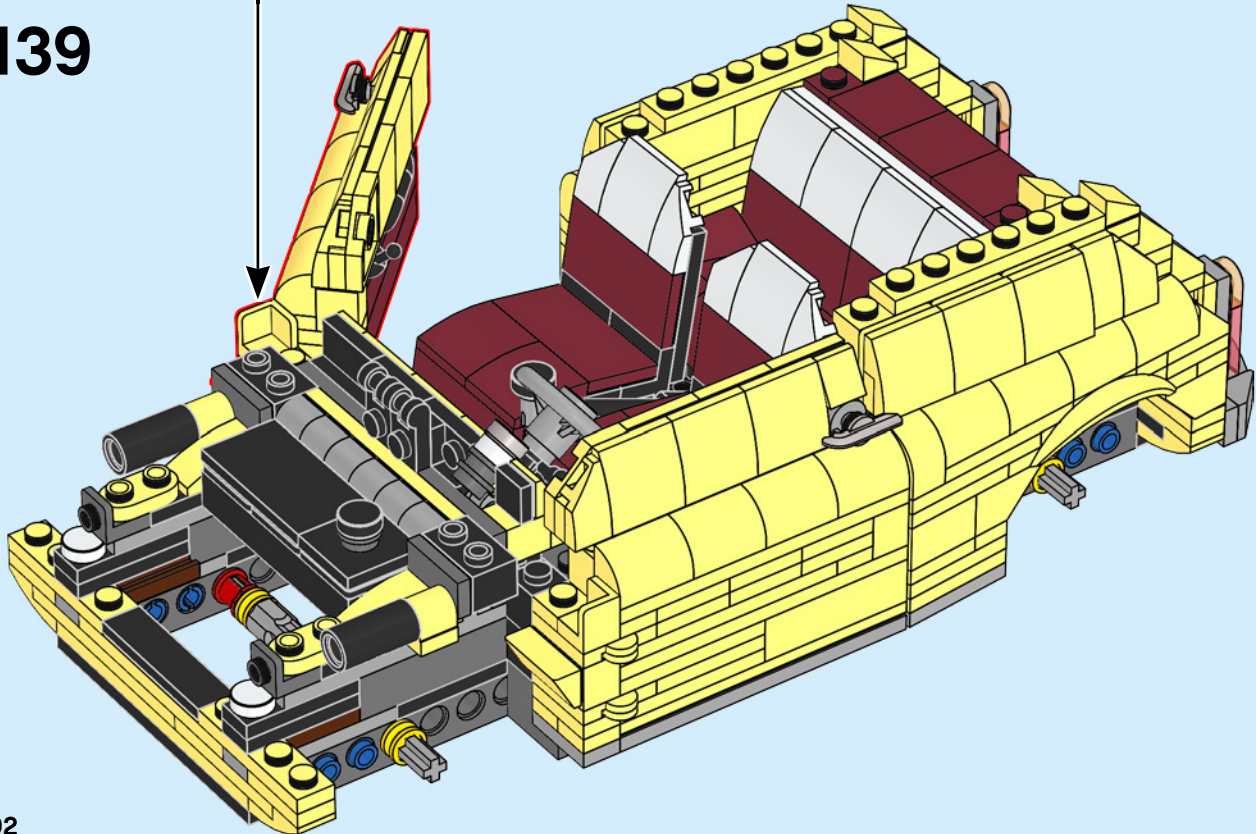

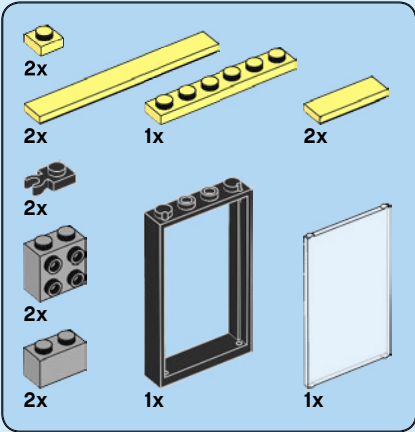
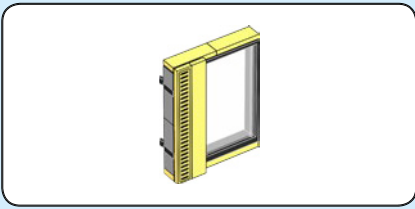

140

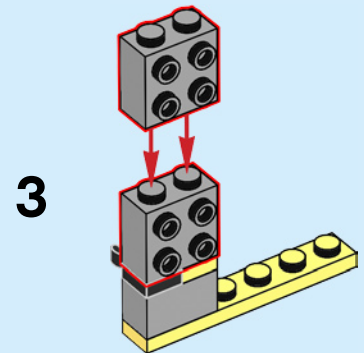
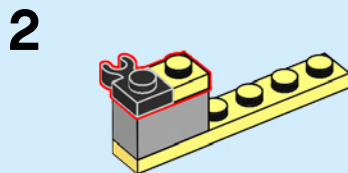
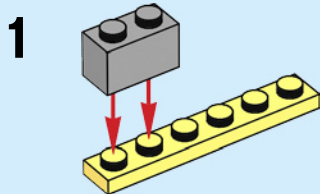

4

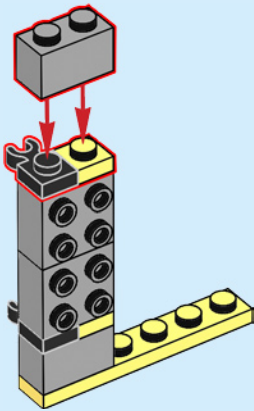

5

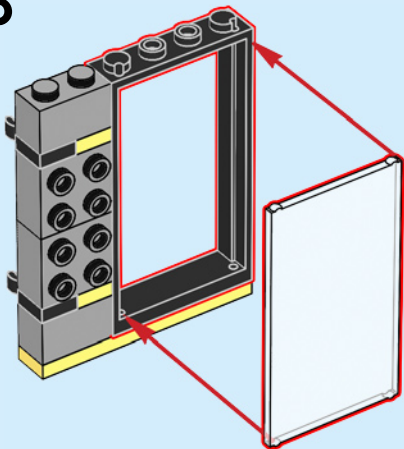

6

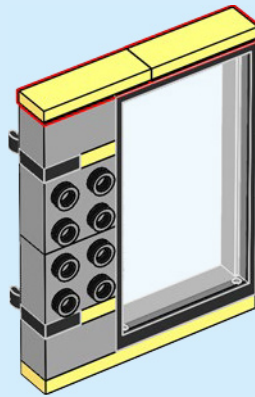

7

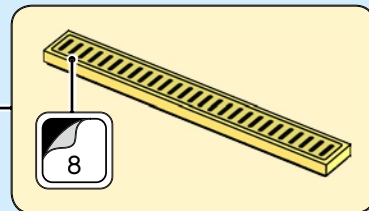
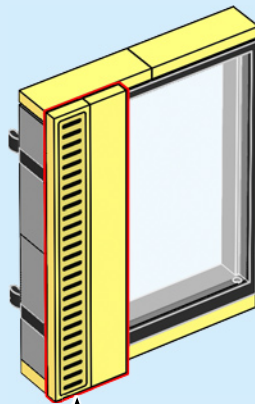

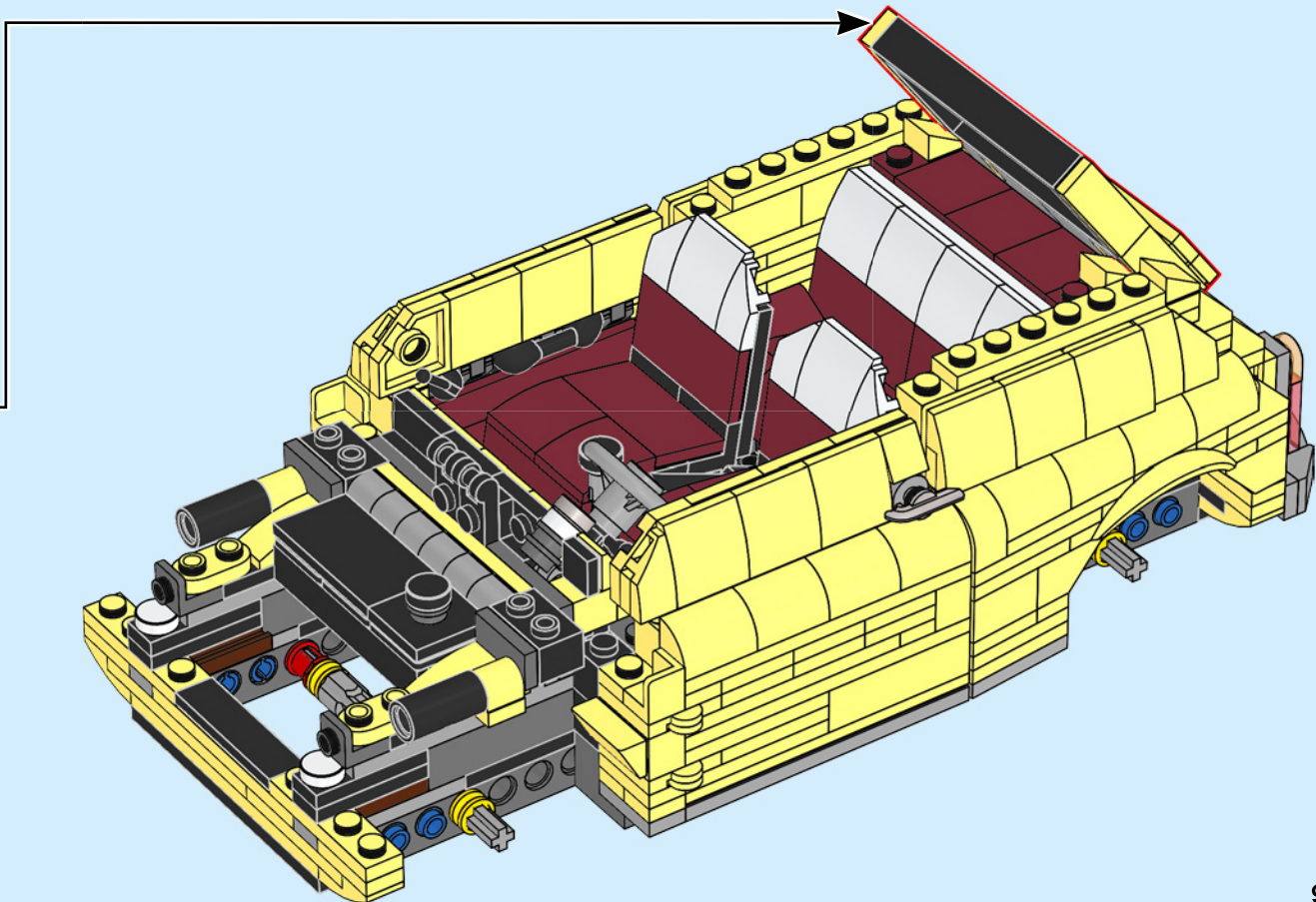

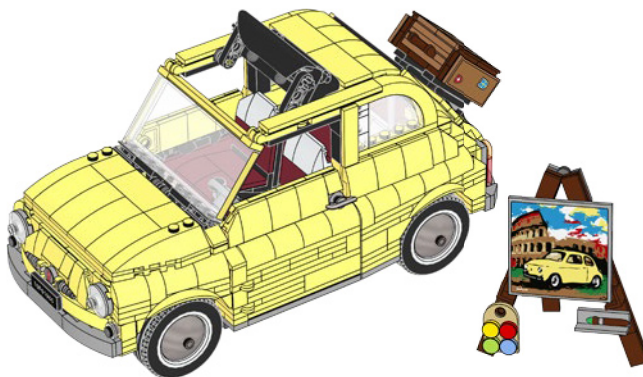
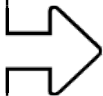
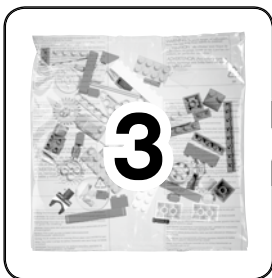

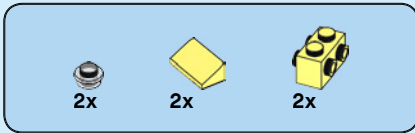

141

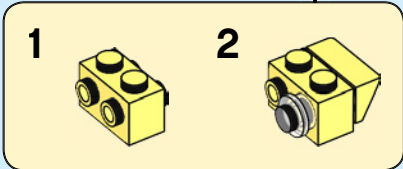
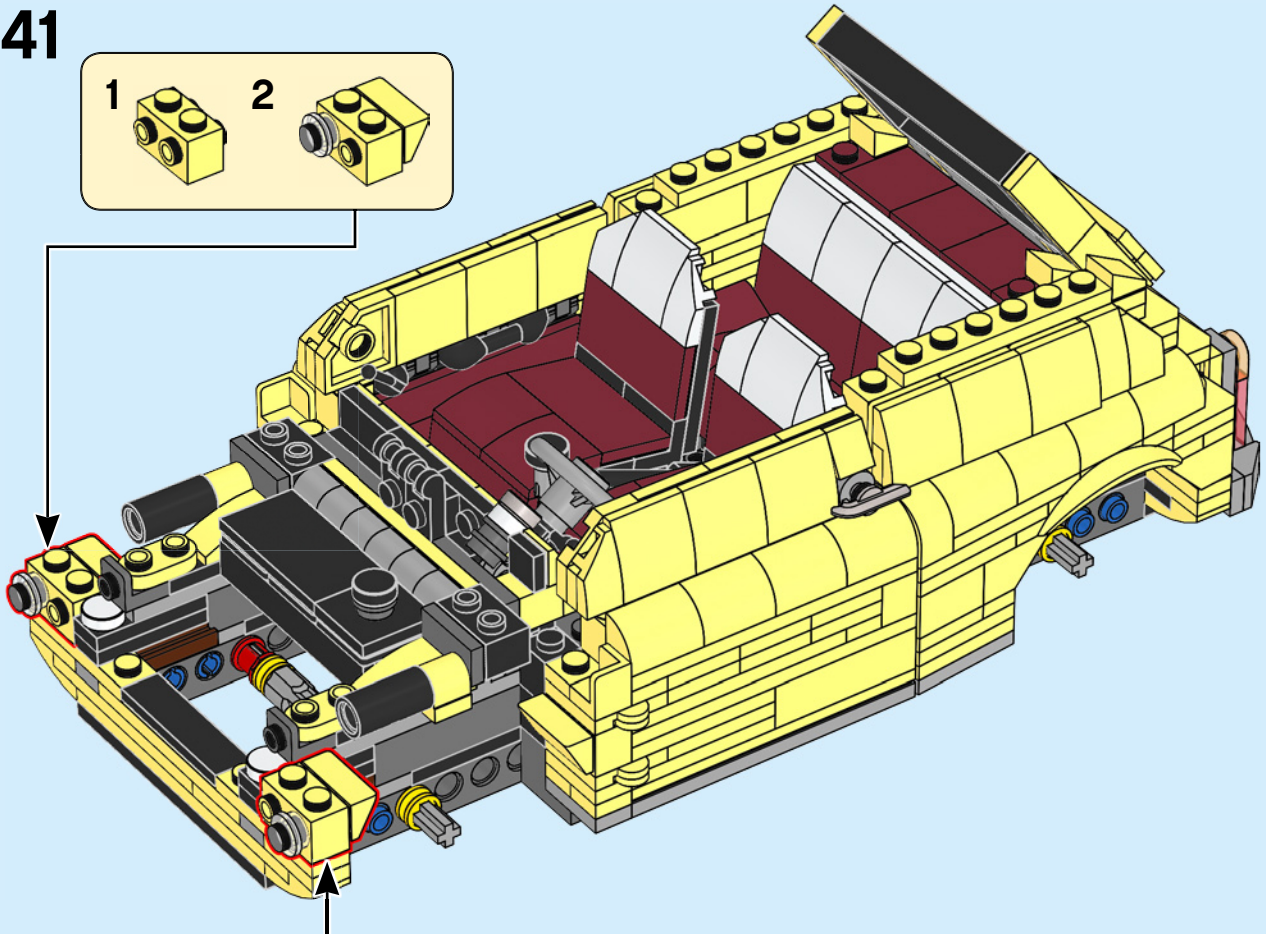
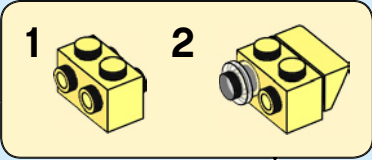

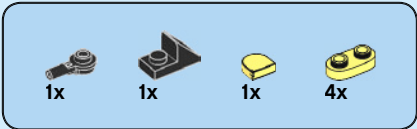

142

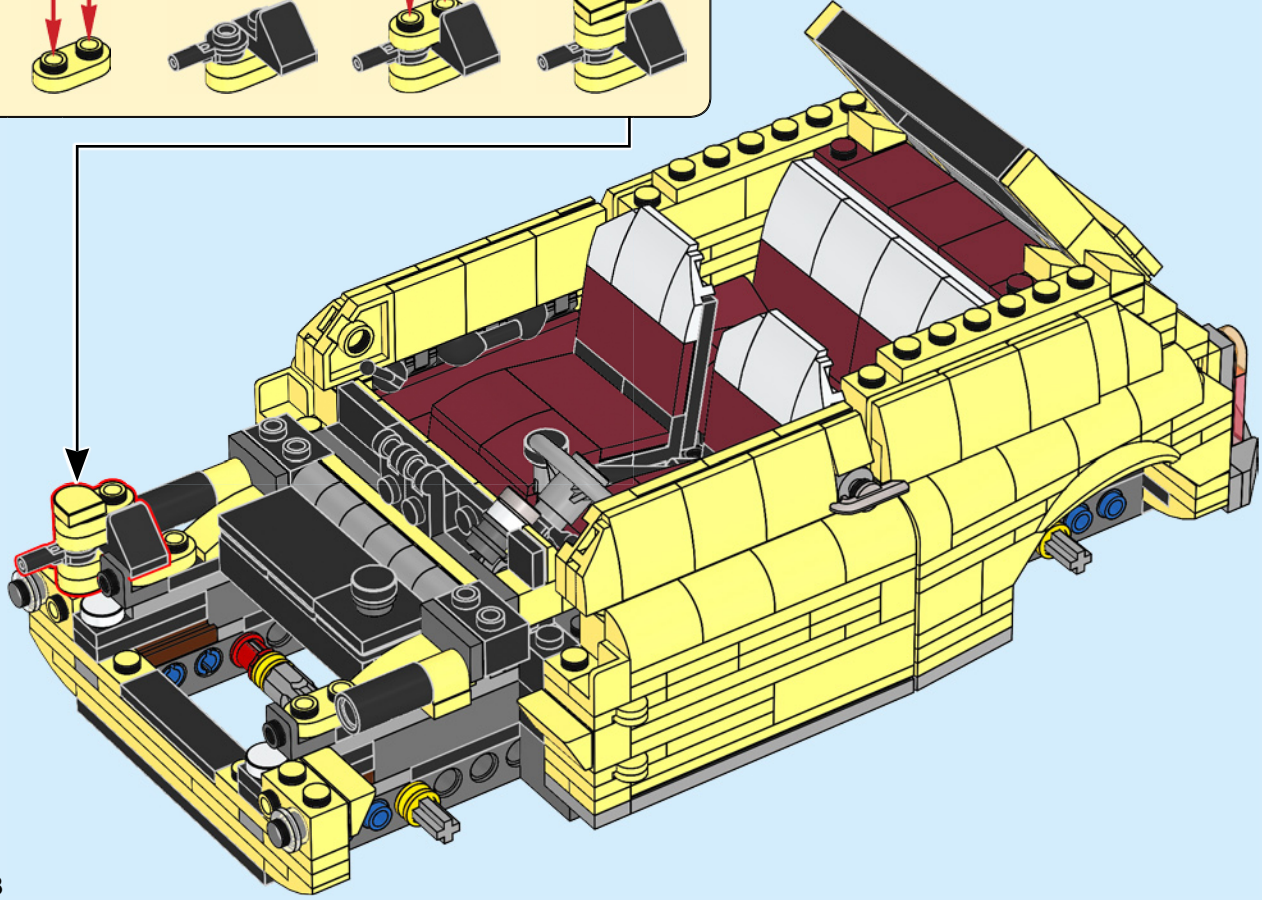
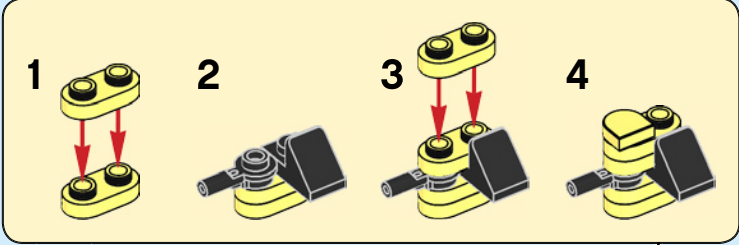

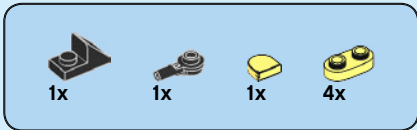

143

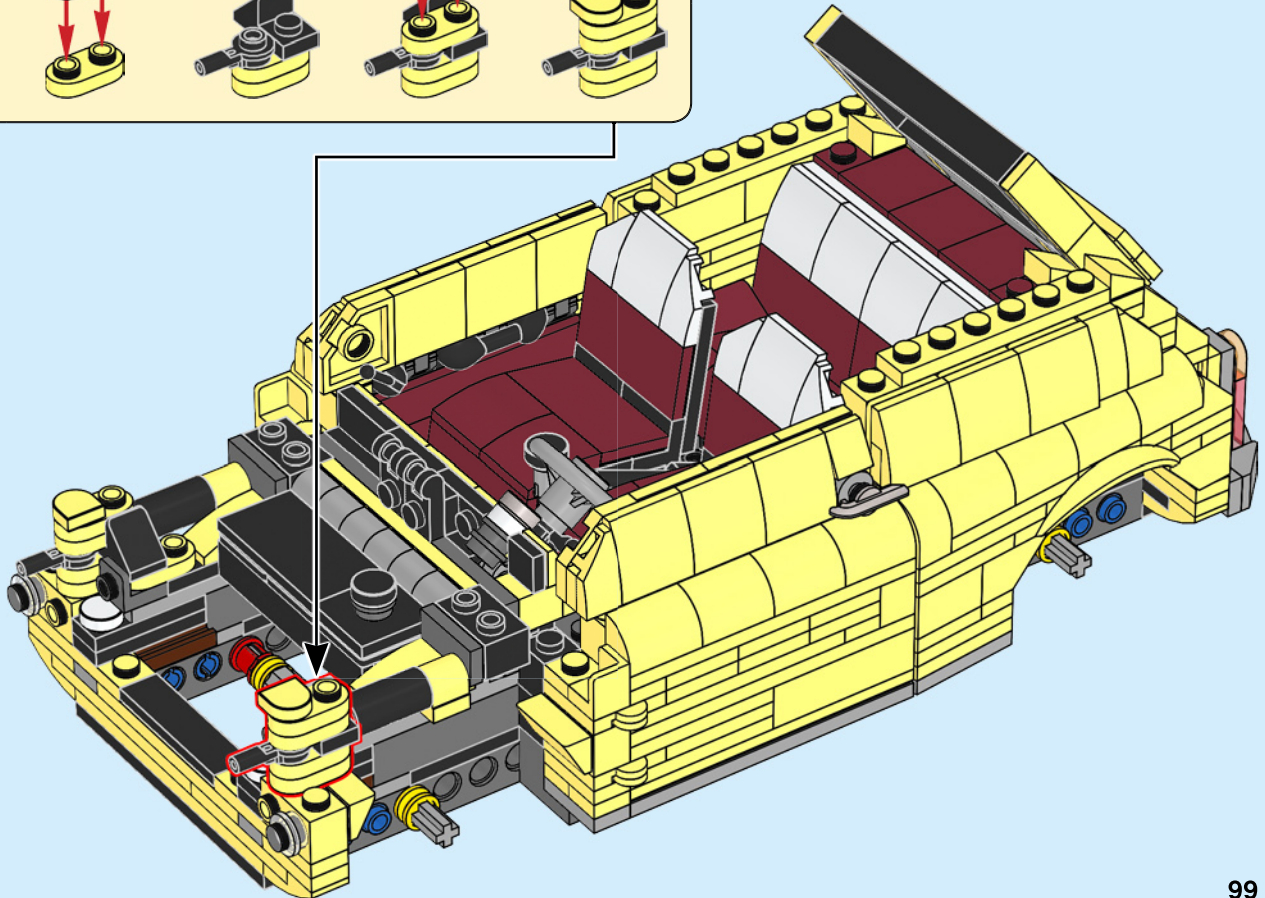
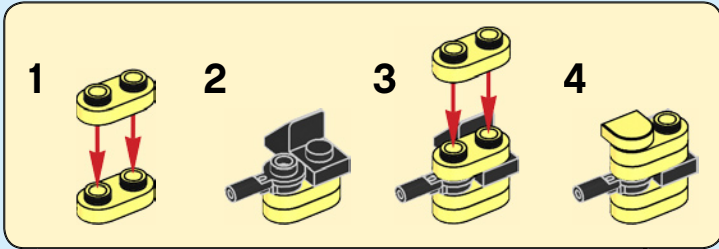

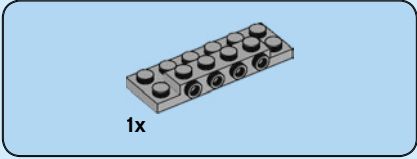
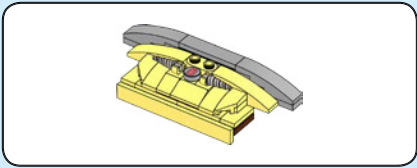

1x

144

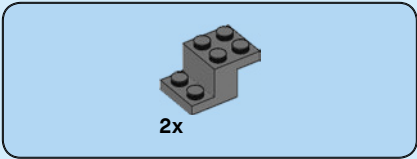
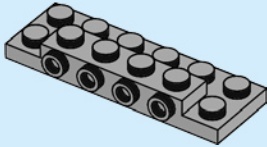

2x

145

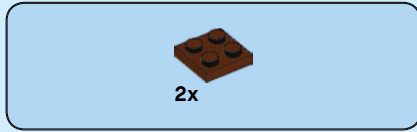
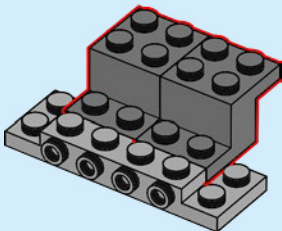

2x

146

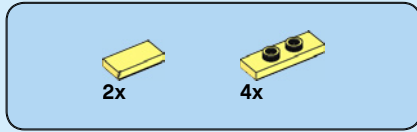
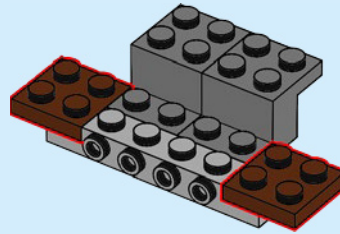

2x

4x

147

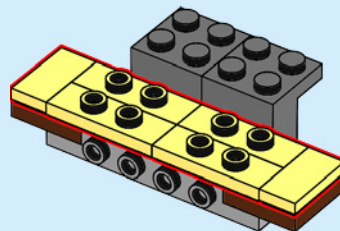

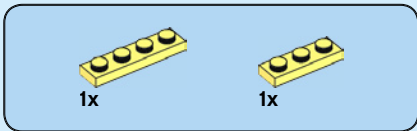

148

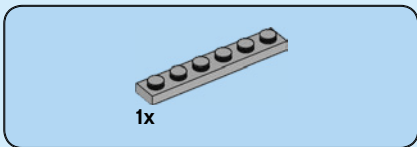
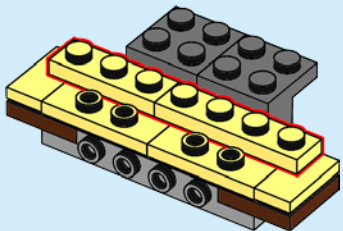

149

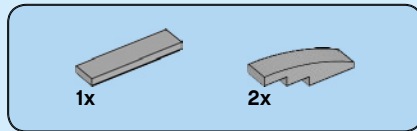
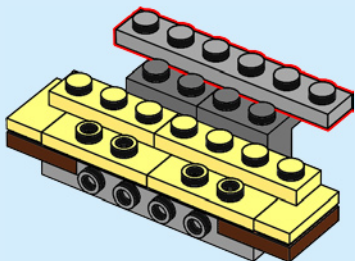

150

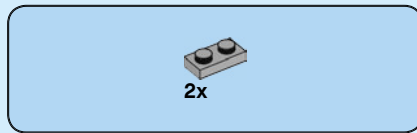
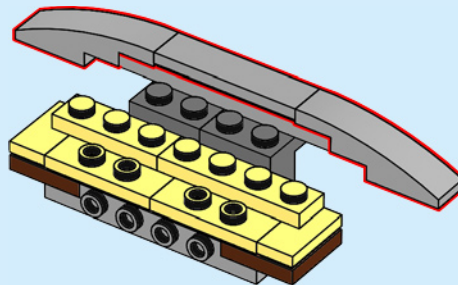

151

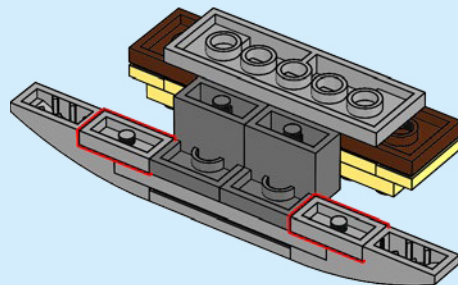
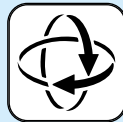



2x



2x

152

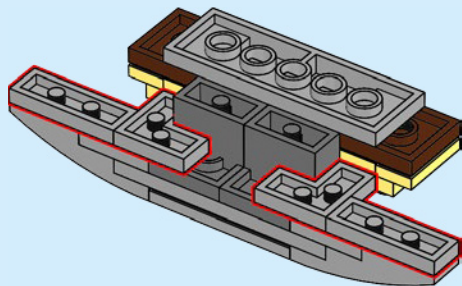

1x



2x

153

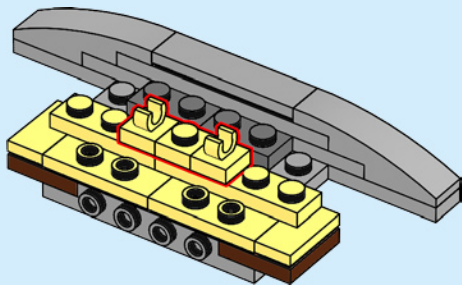
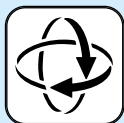

2x



1x



1x



1x



1x

154

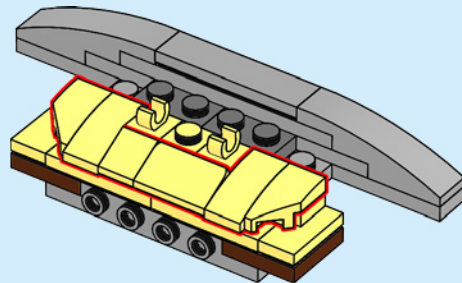

2x



1x



2x

155

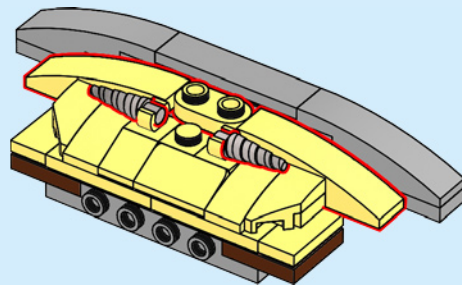

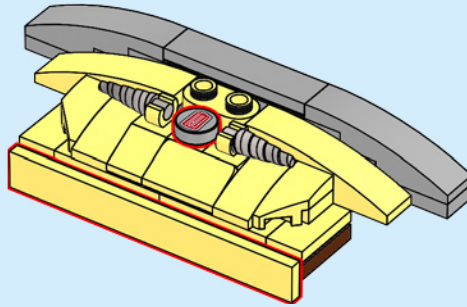
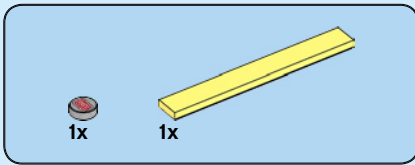

156

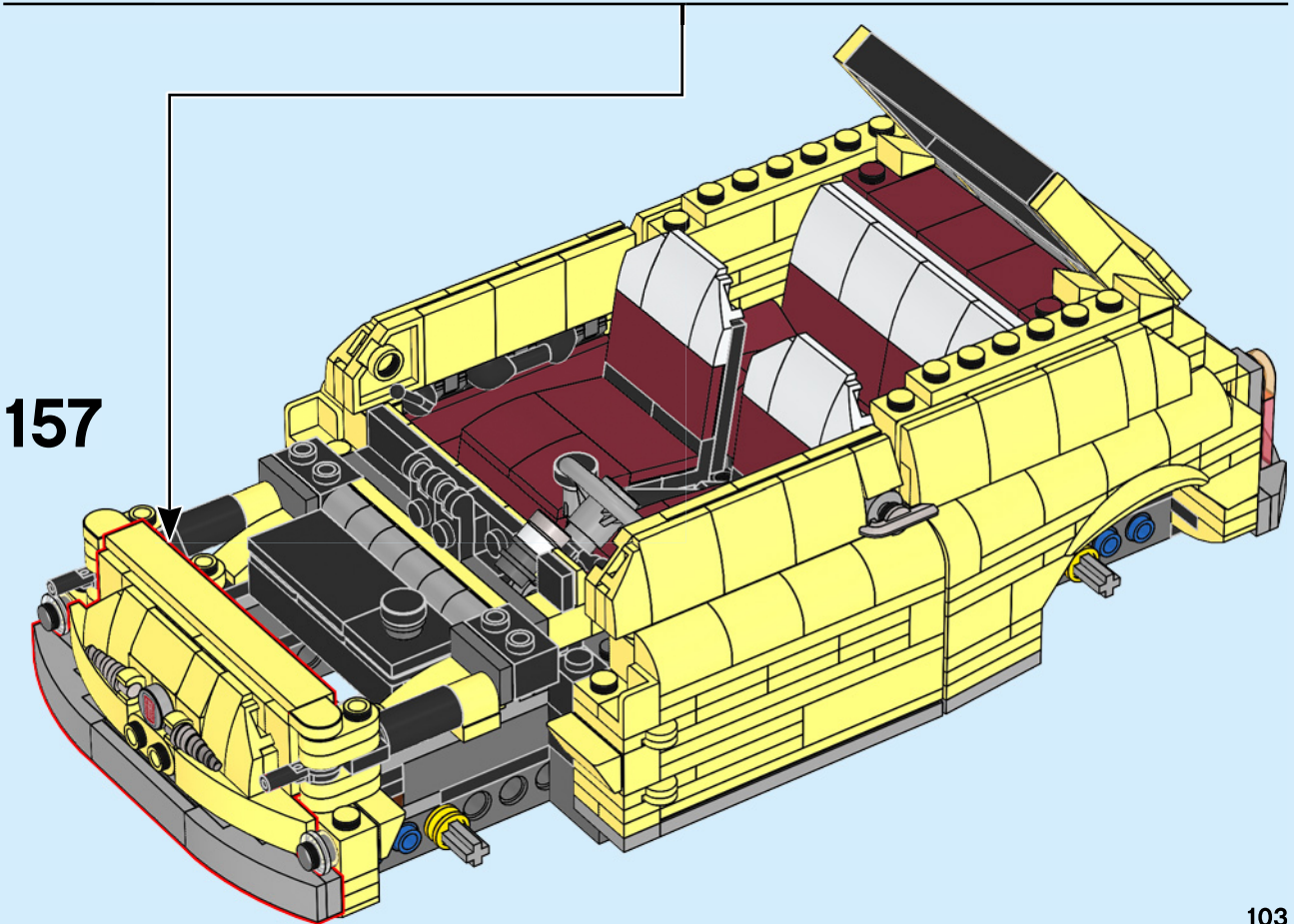

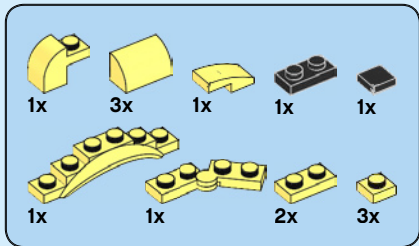

158

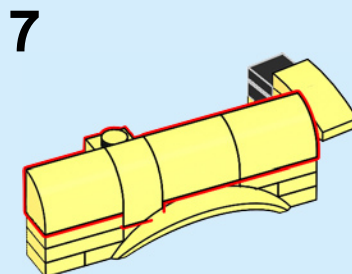
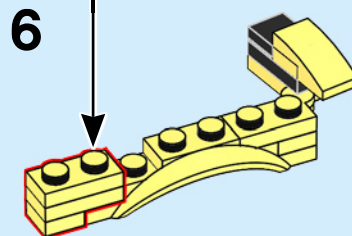
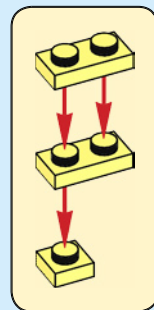
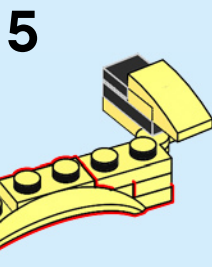
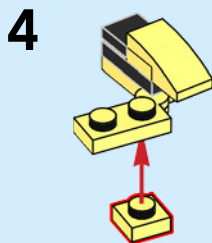
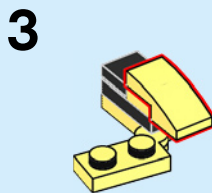
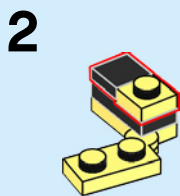
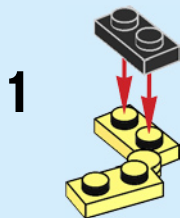

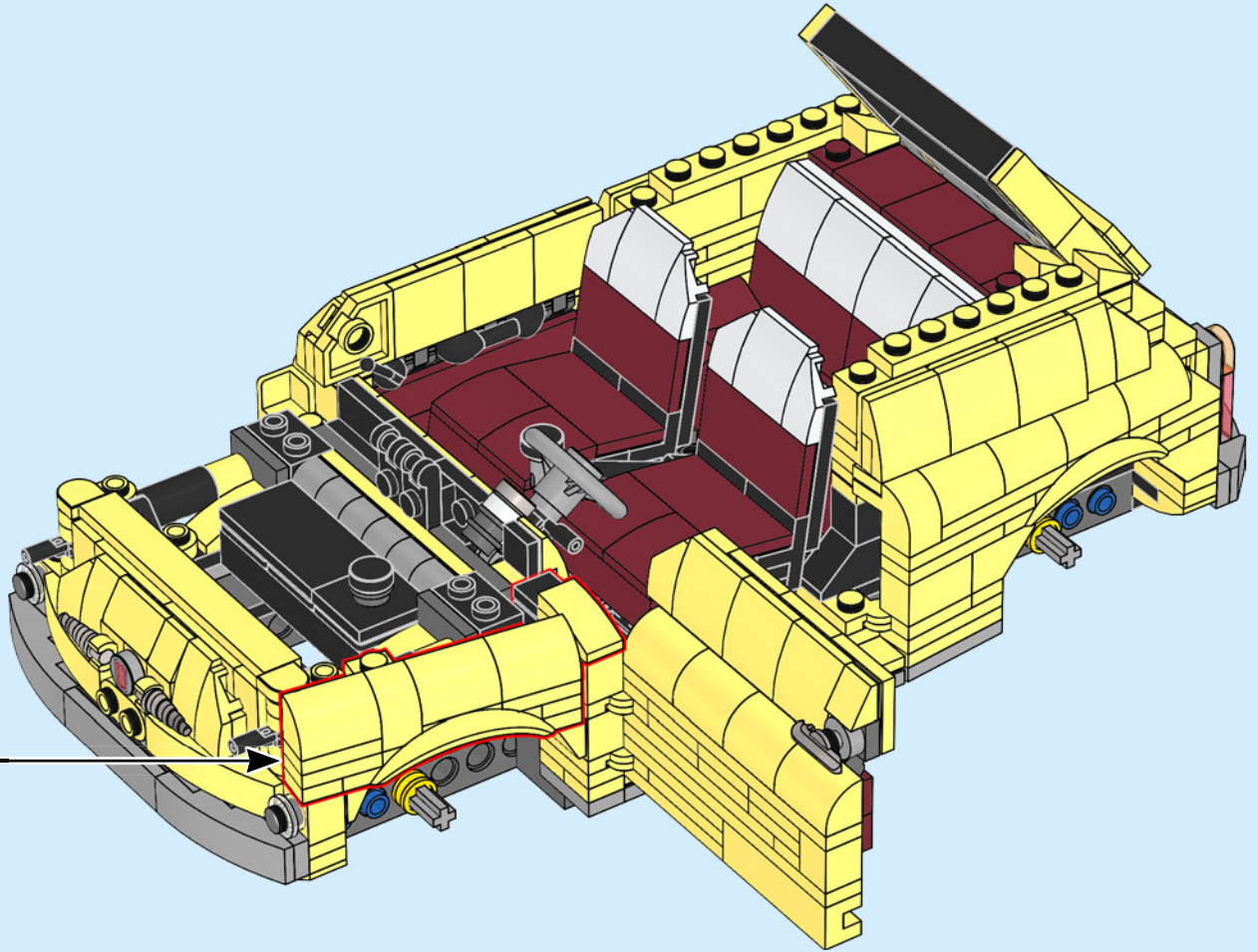

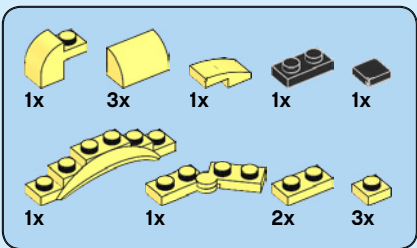

159

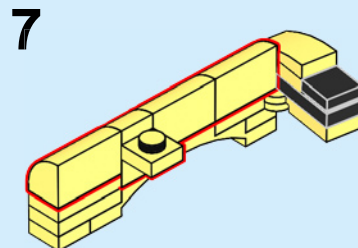
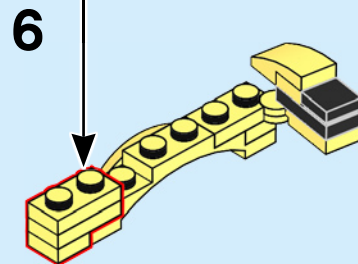
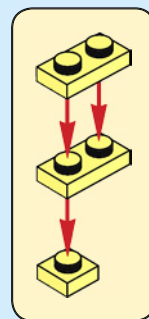
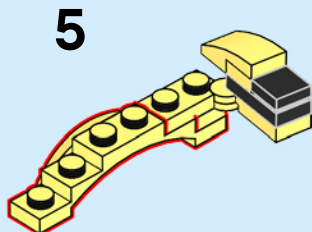
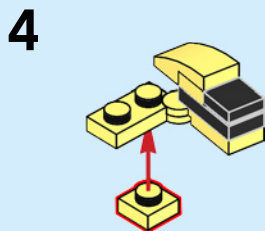
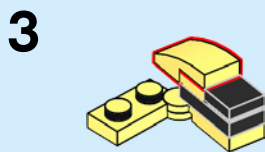
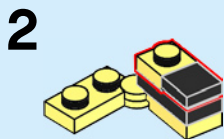
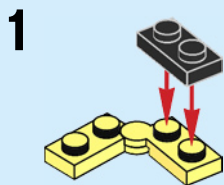

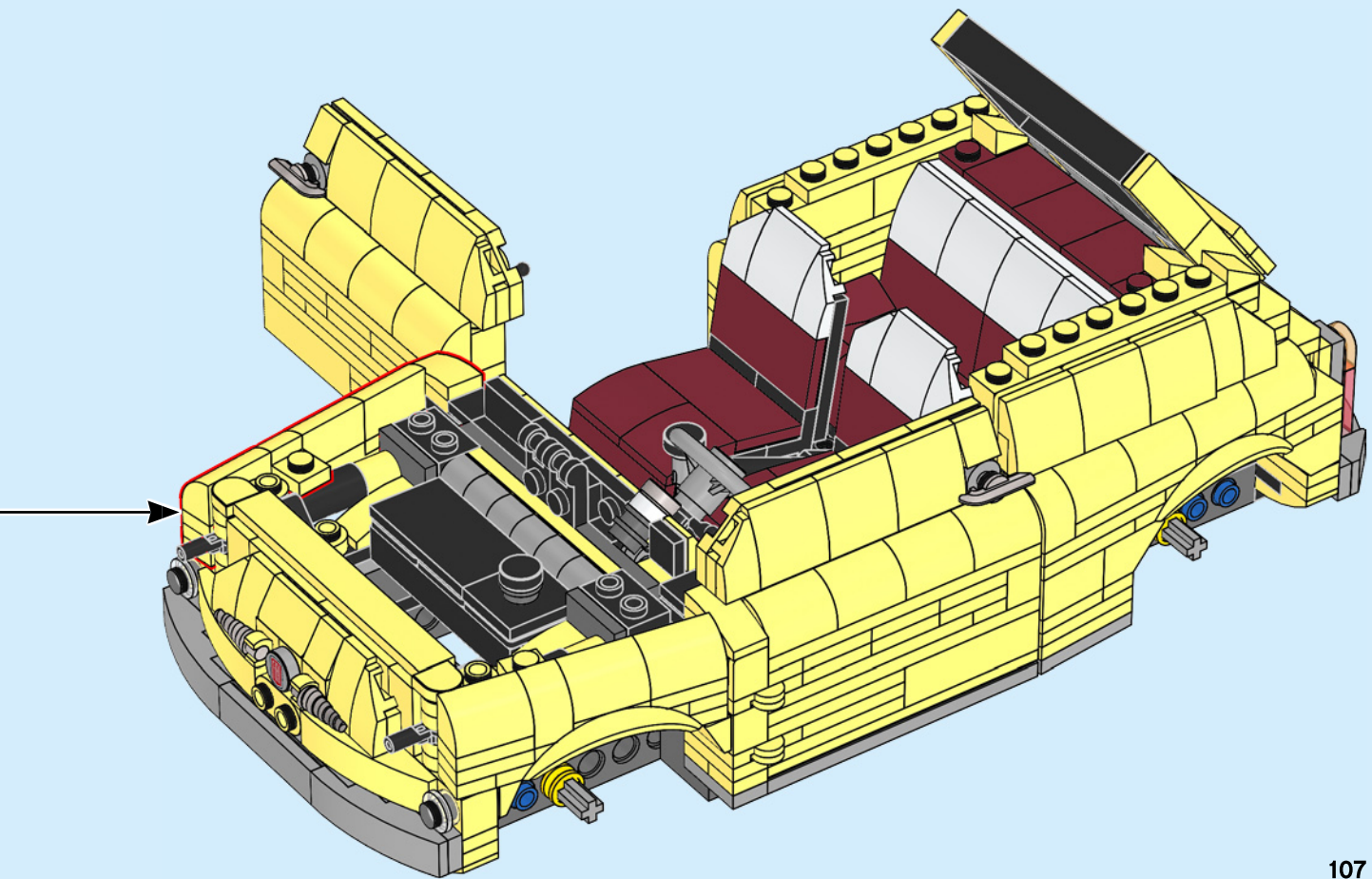

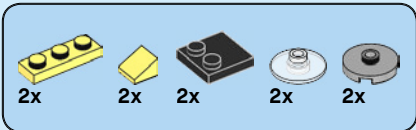

160

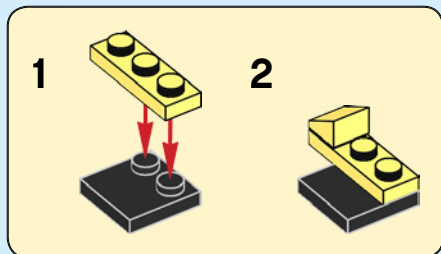

2

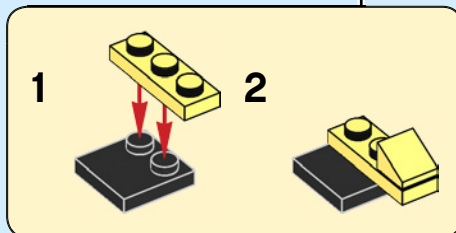
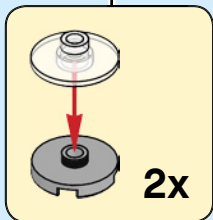
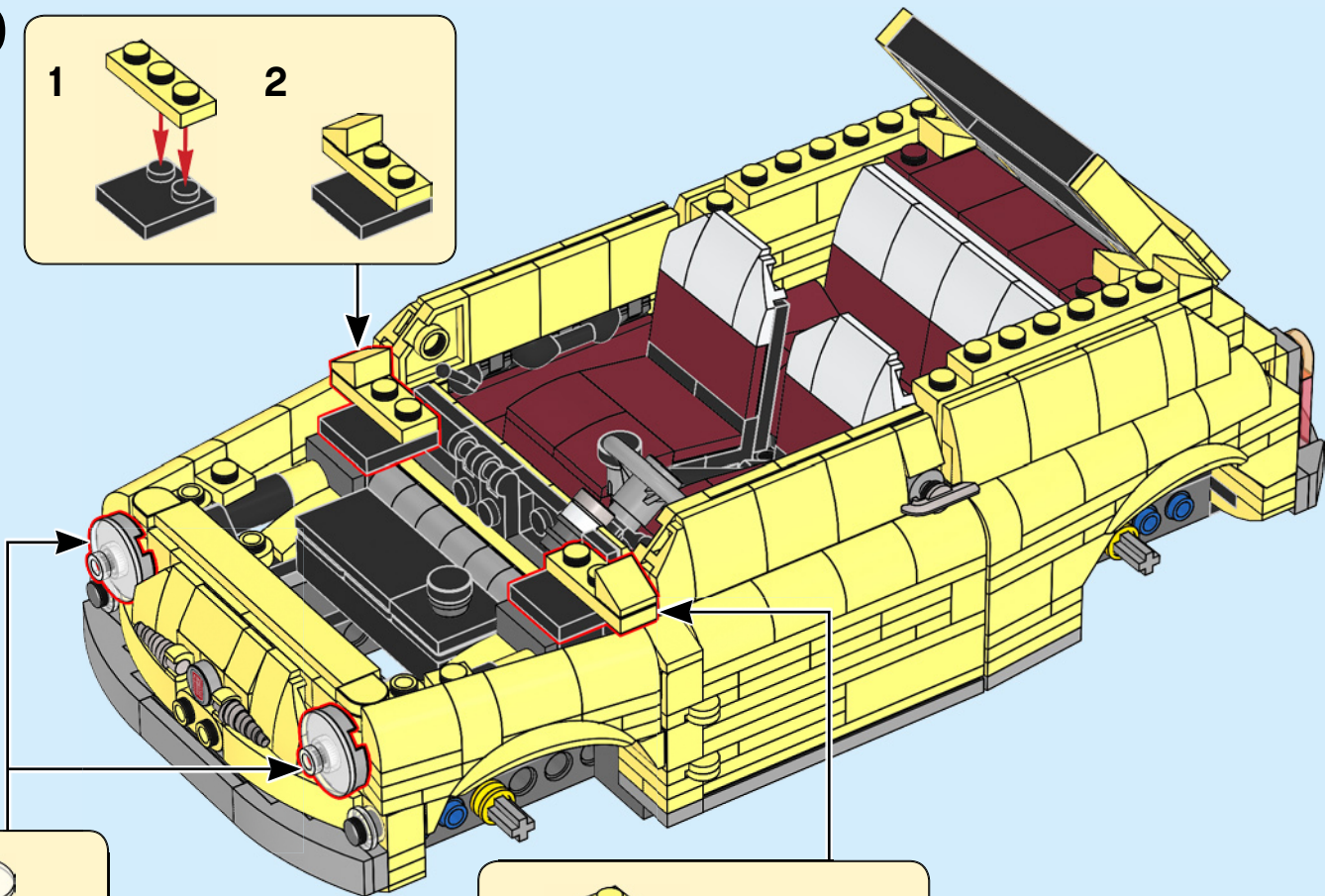
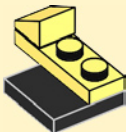

2

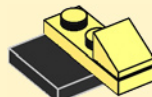

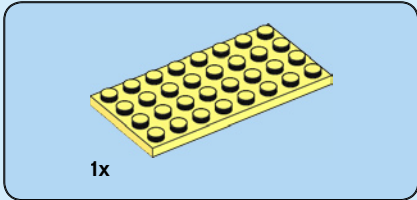
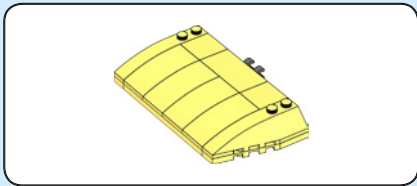

1x

161

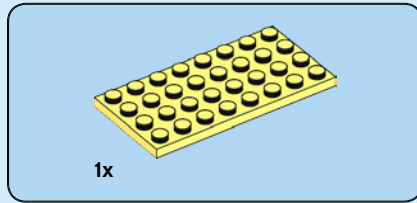
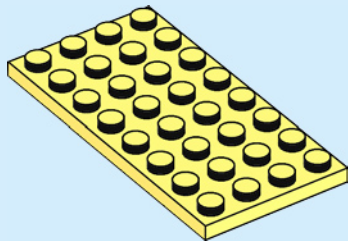

1x

162

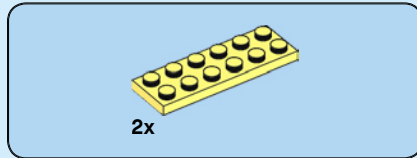
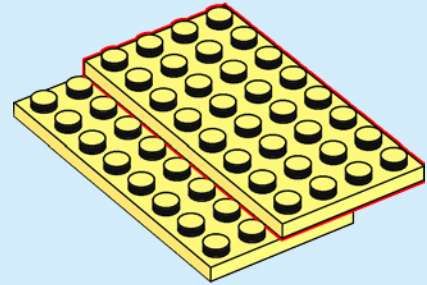

2x

163

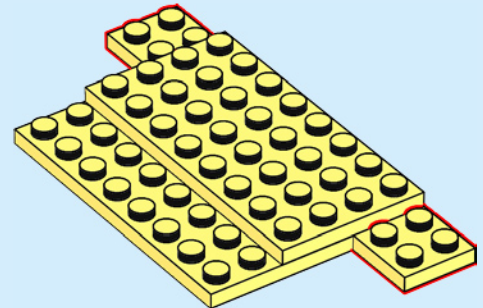

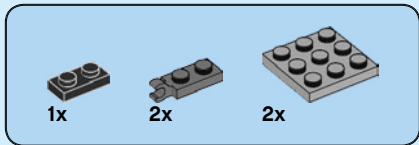

164

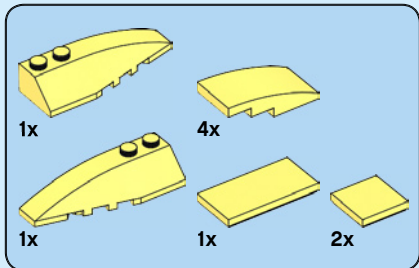
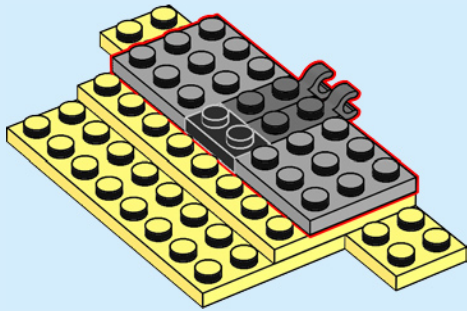

165

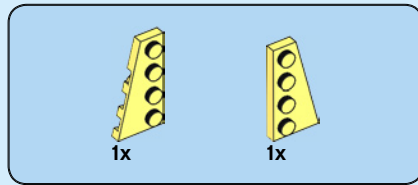
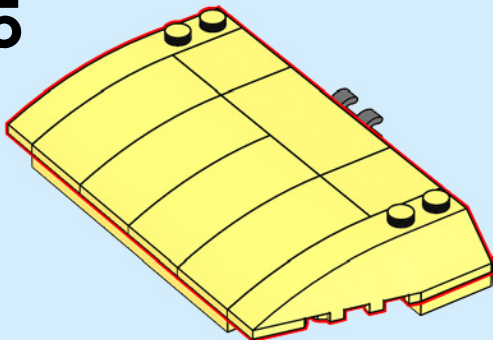

166

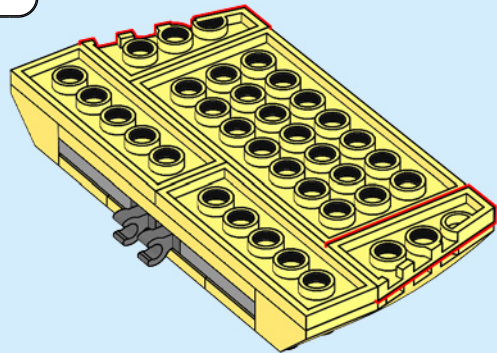
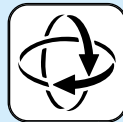

167

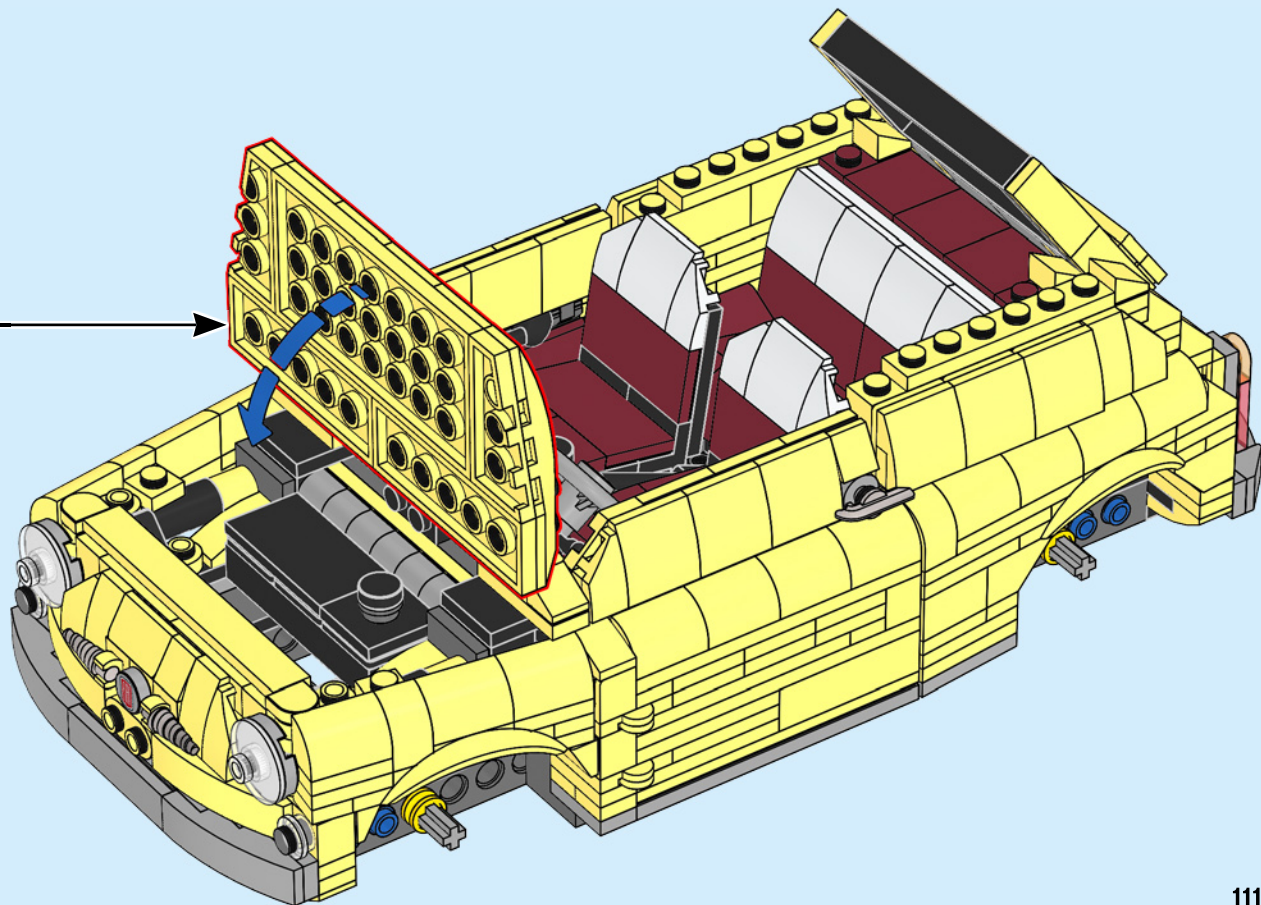

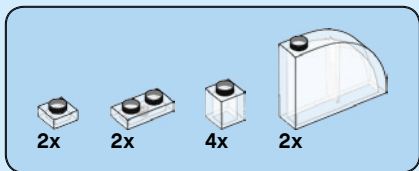

168

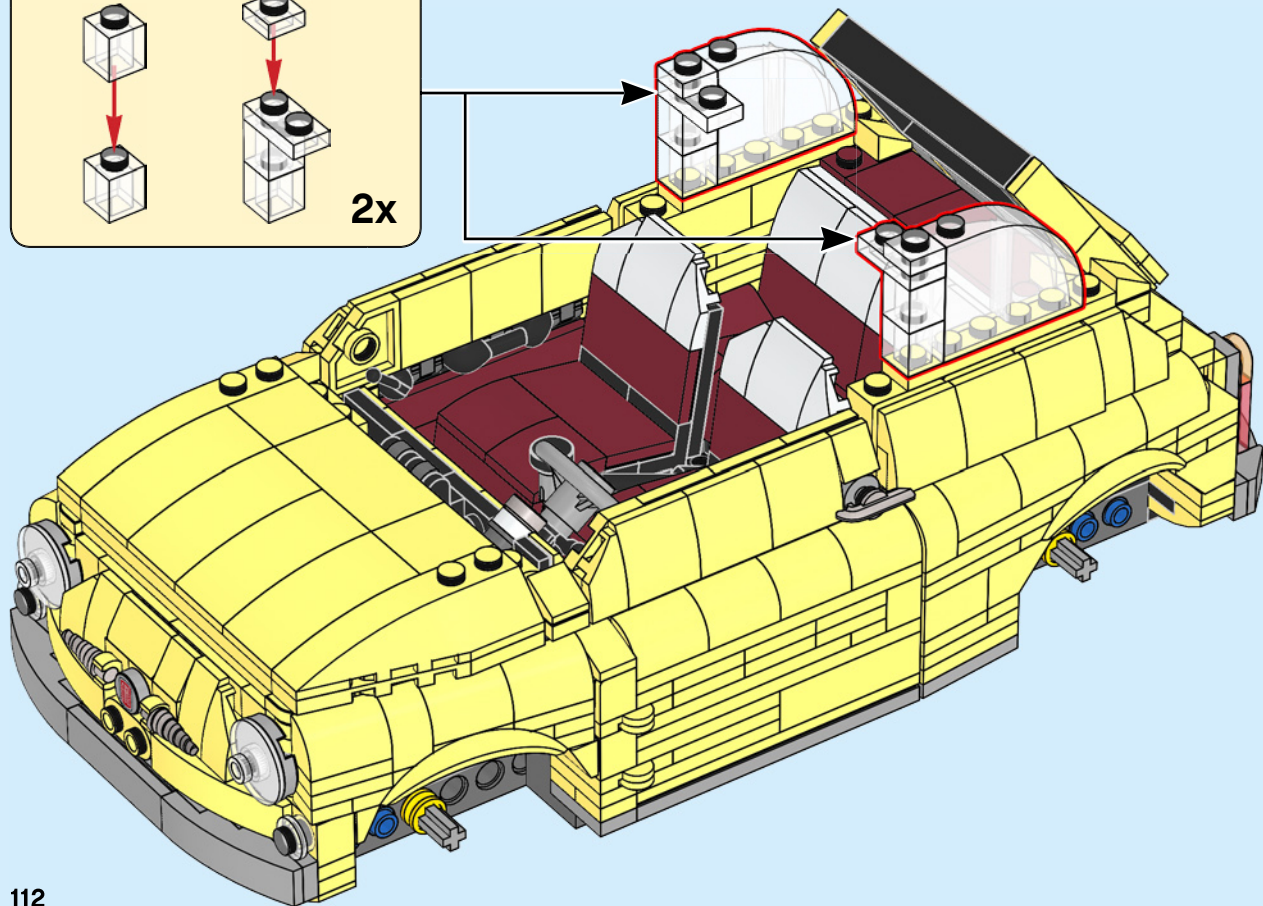
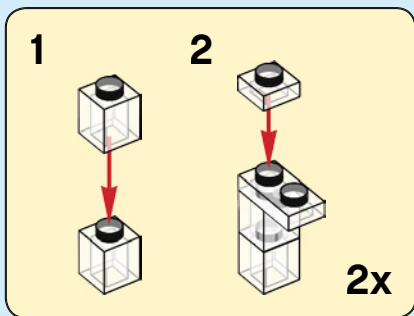

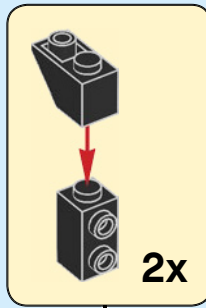
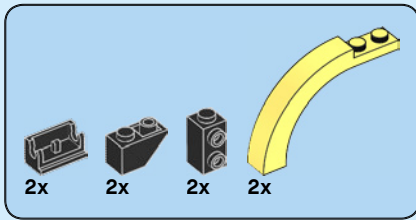

169

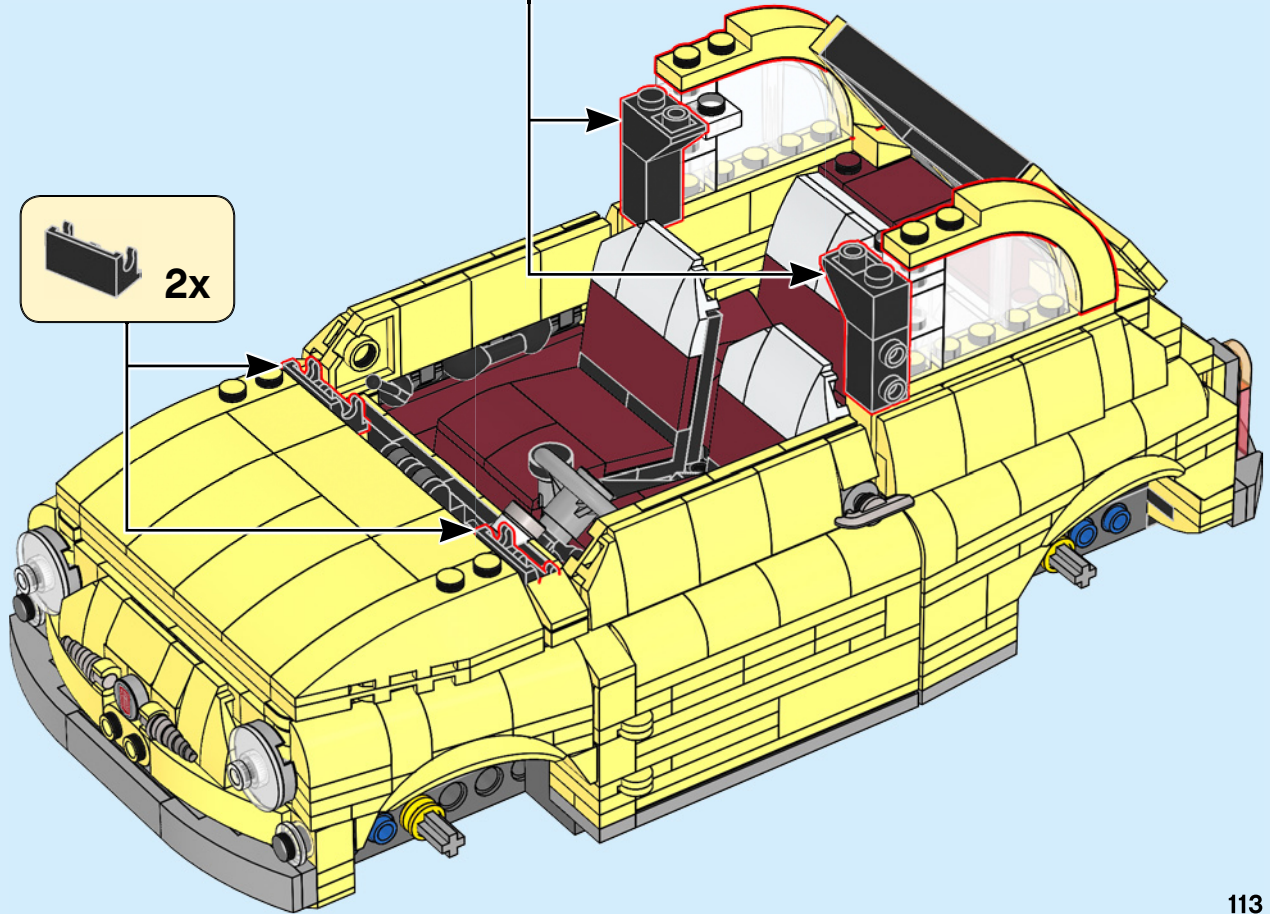
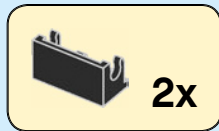

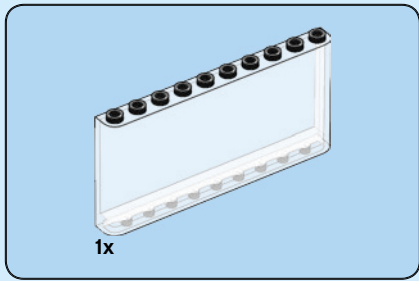

170

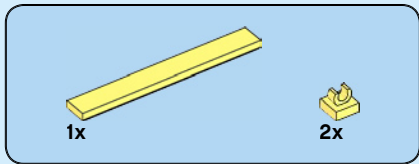
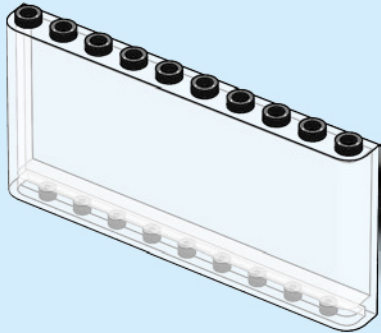

171

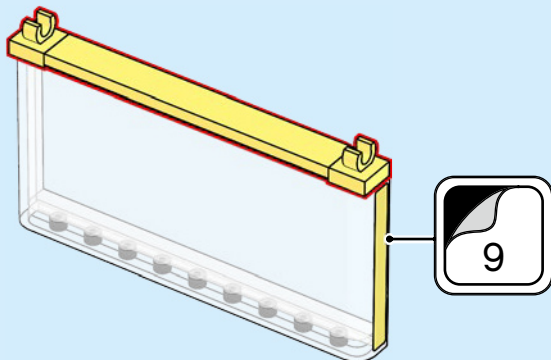

172

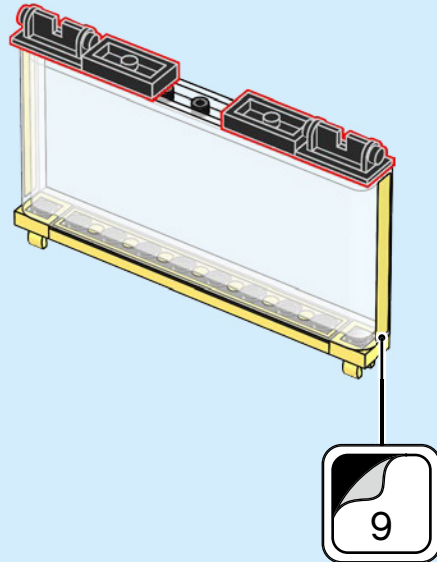
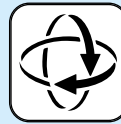

173

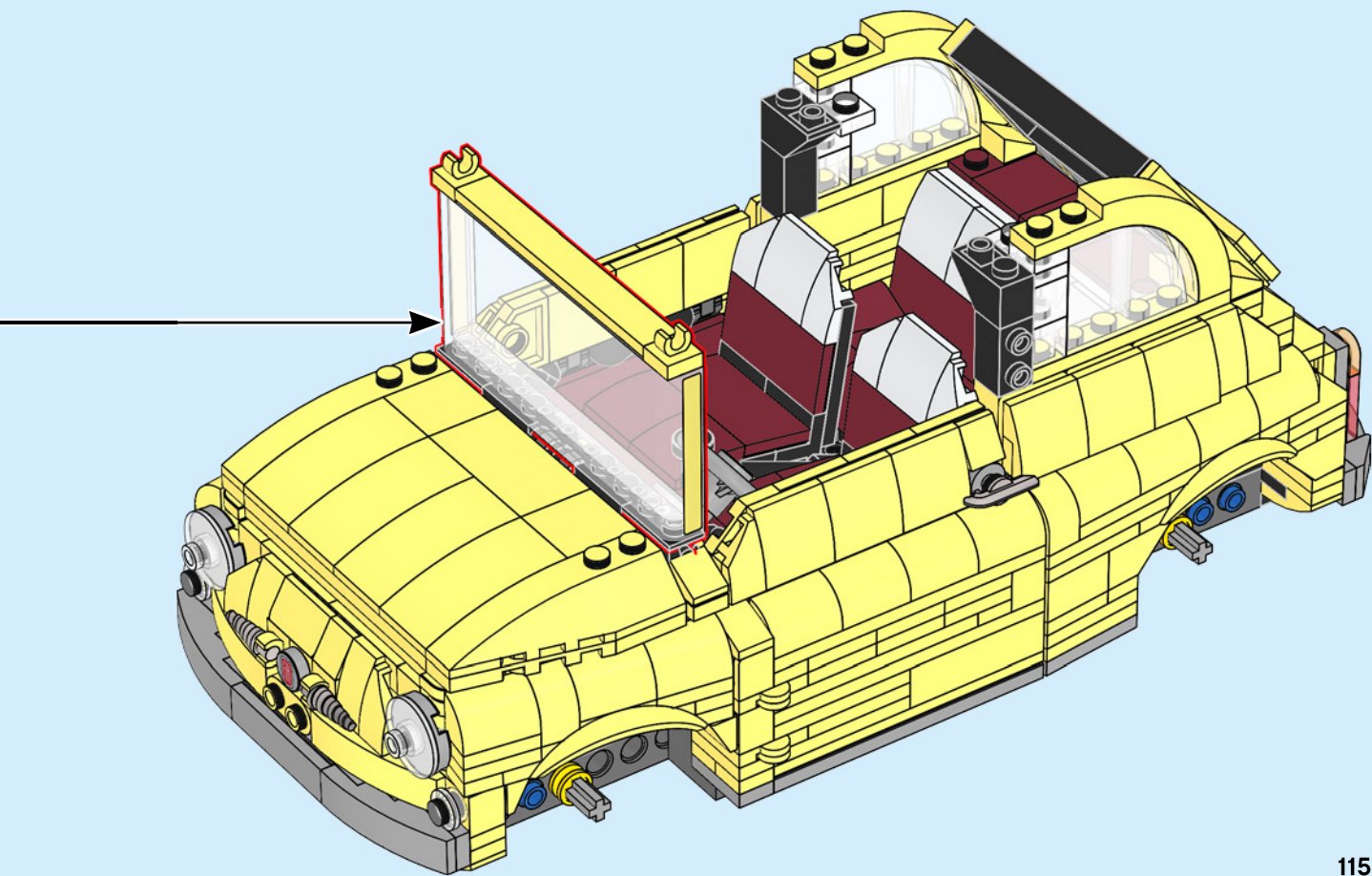

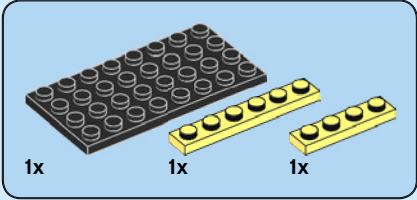
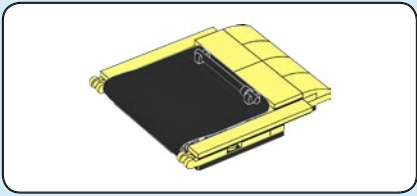

174

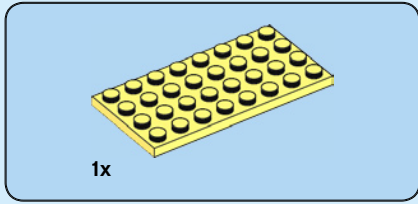
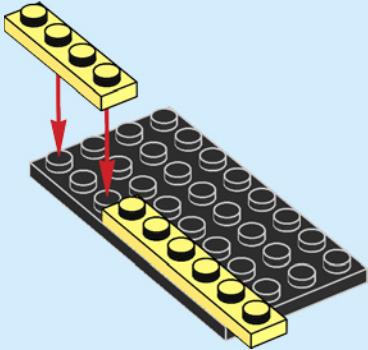

175

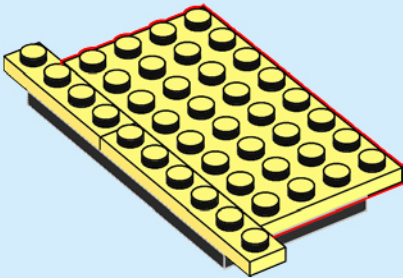

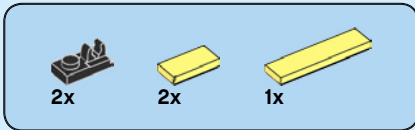

176

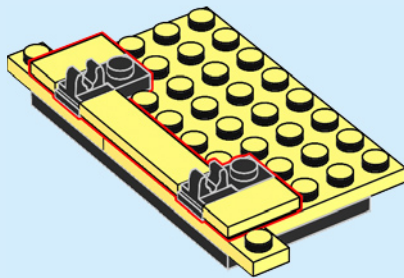

177

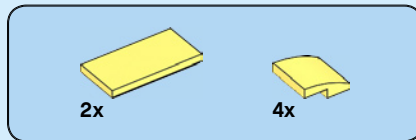
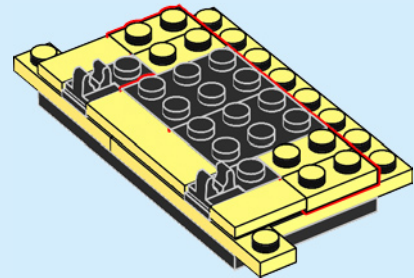

178

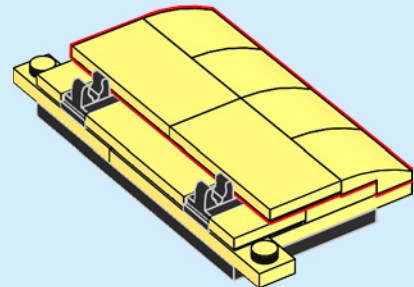

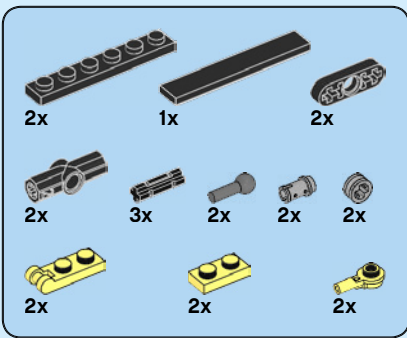

179

1

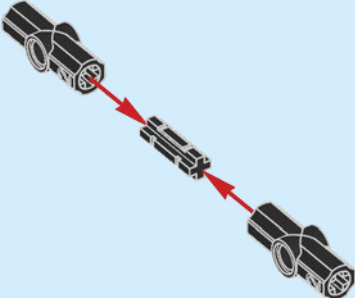

2

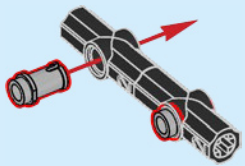

3

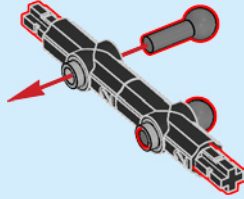

4

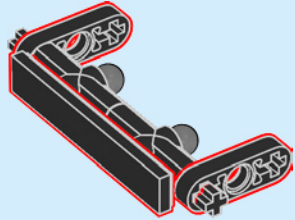

5

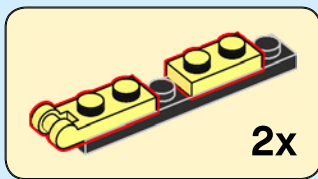
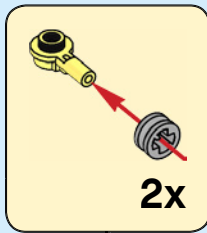
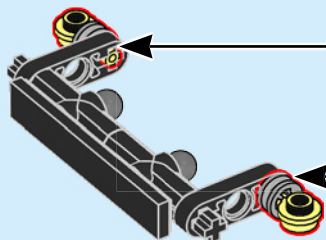

6

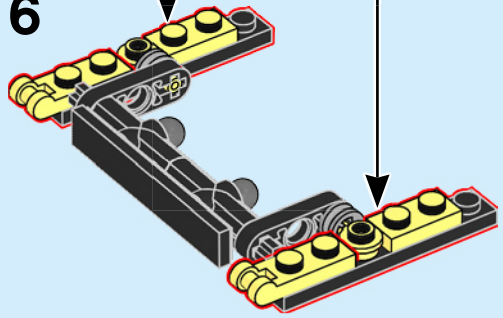

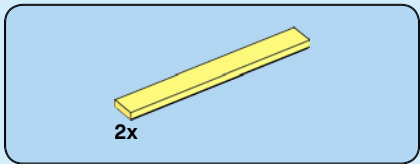

180

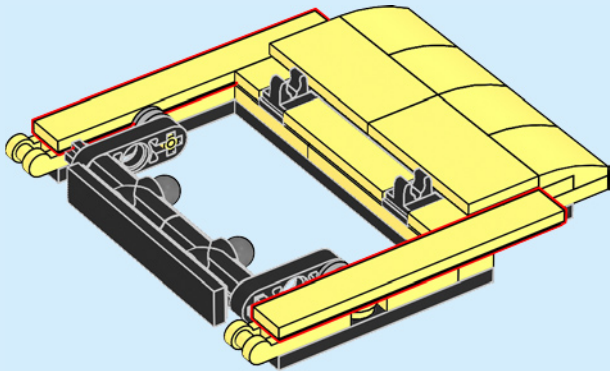
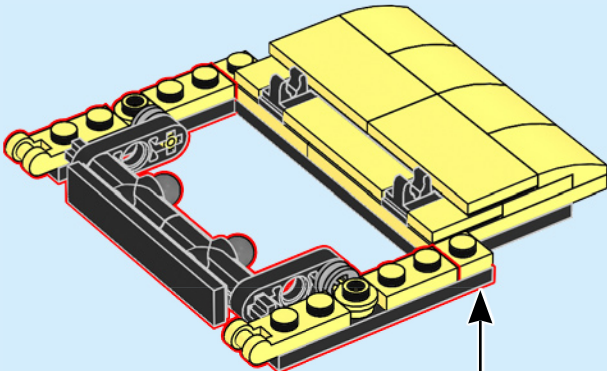

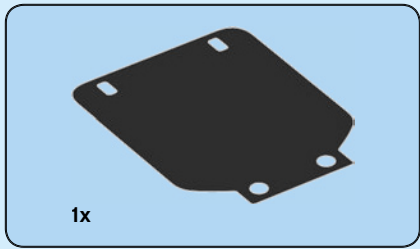

181

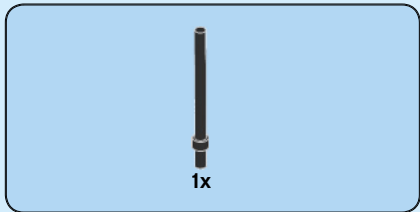
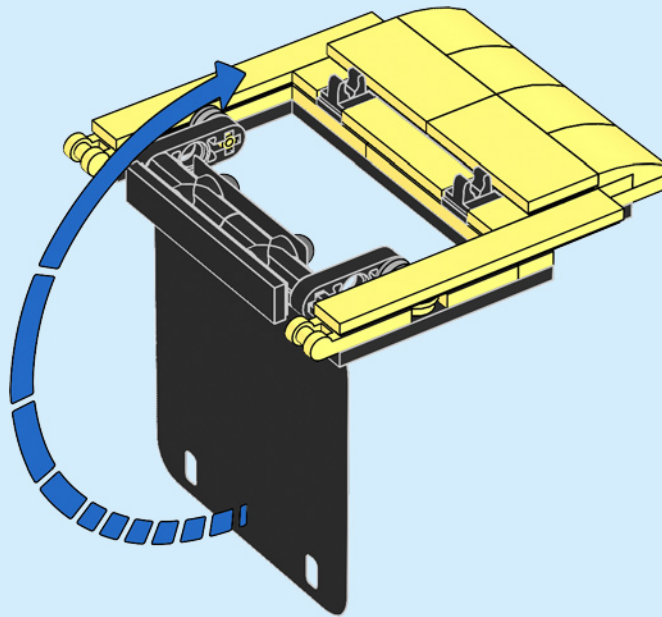

182

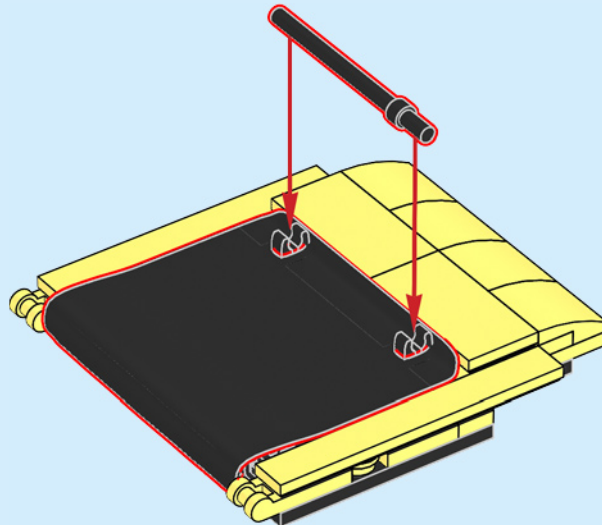

183

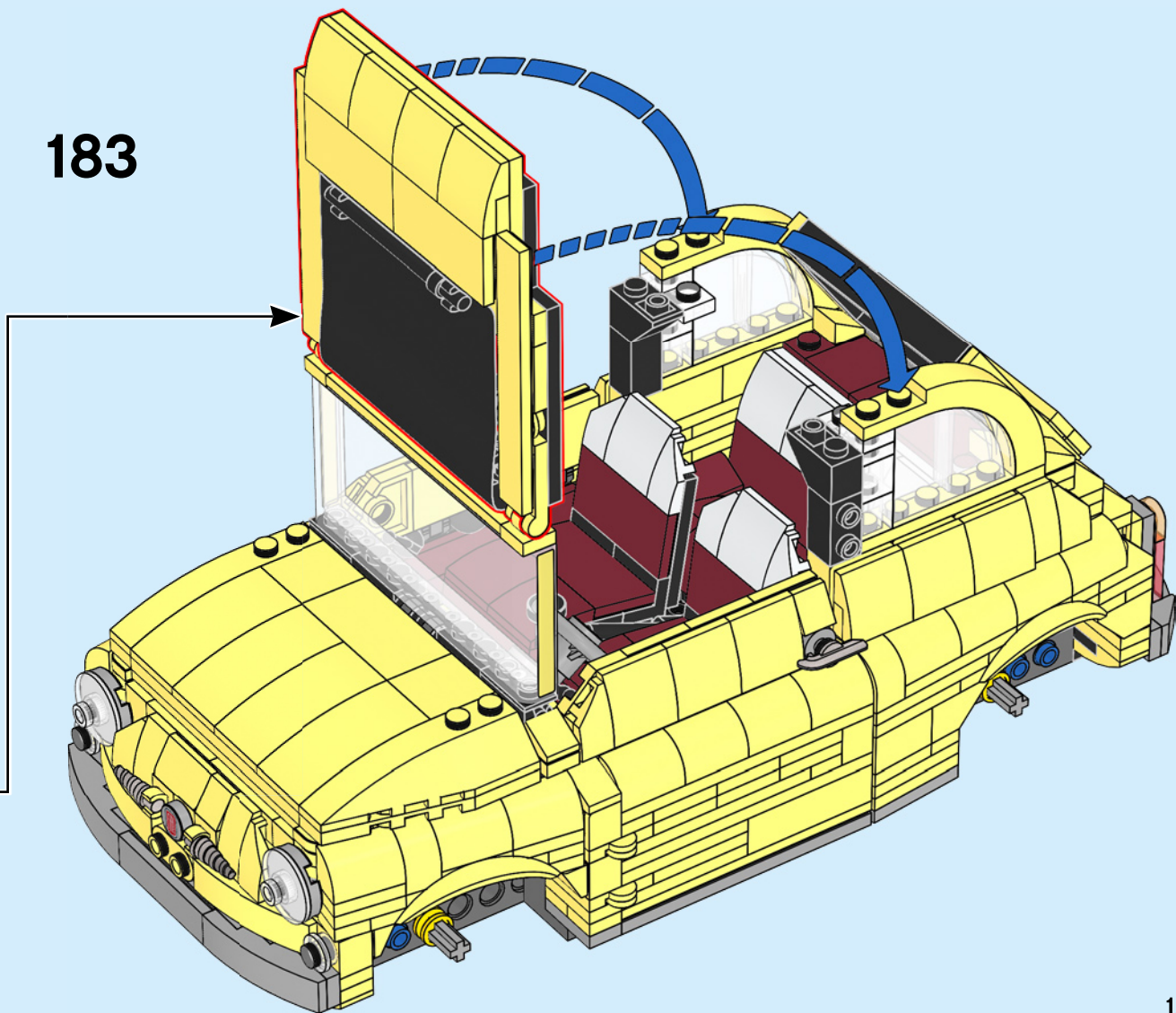

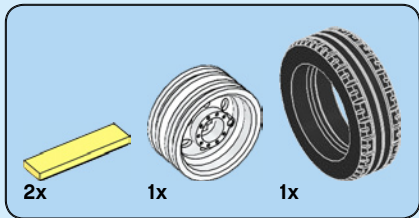

184

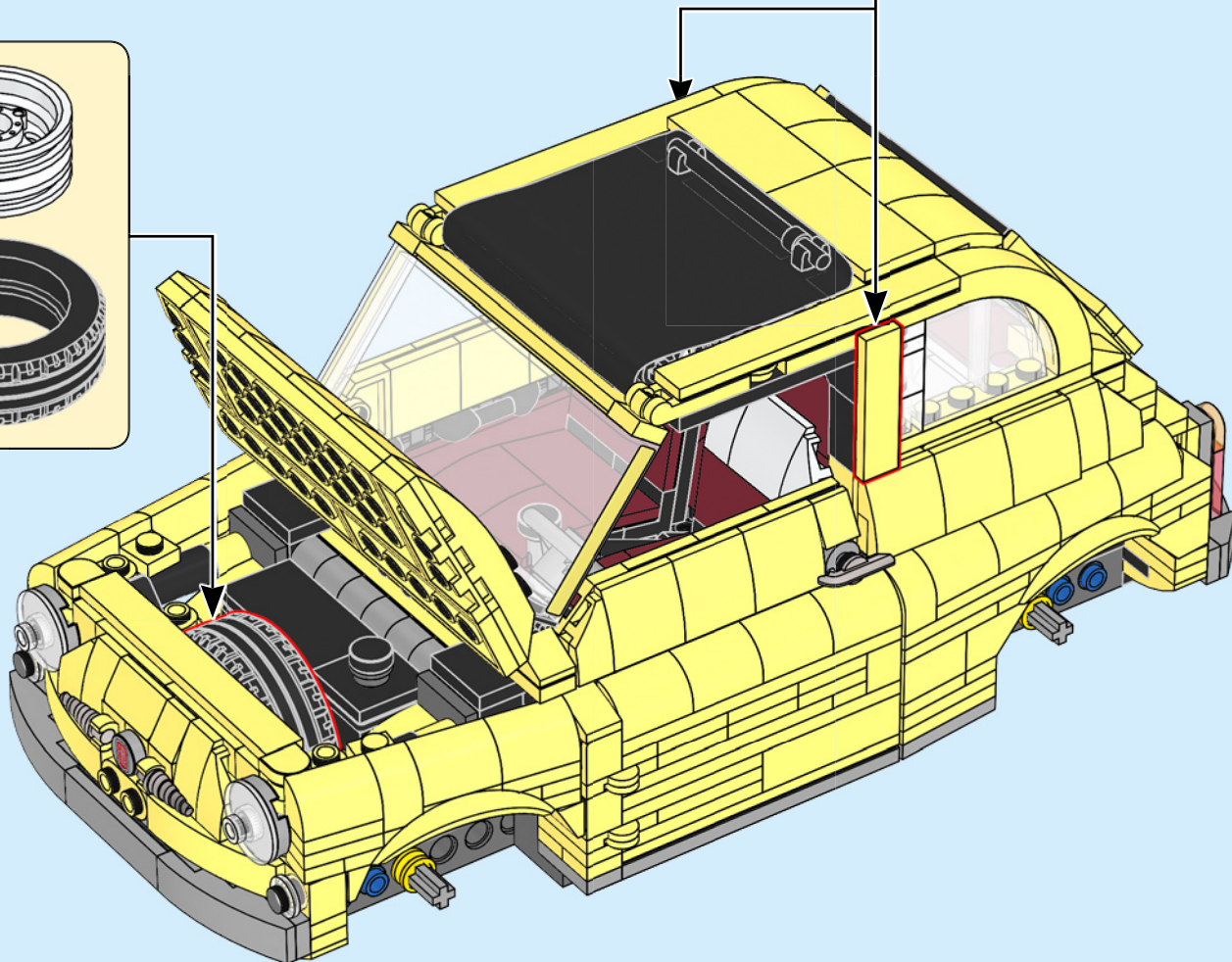
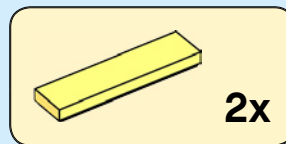
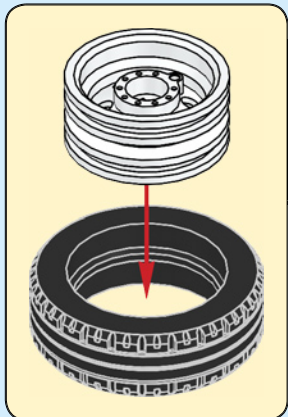

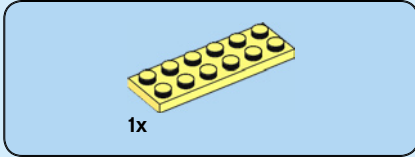
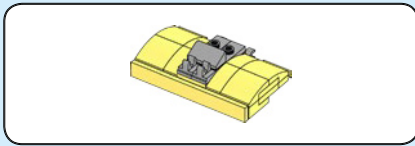

185

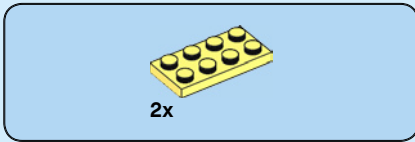
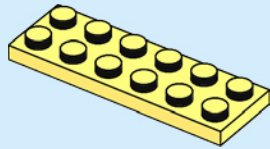

186

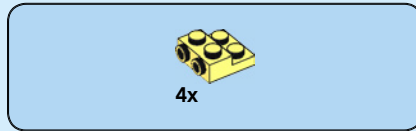
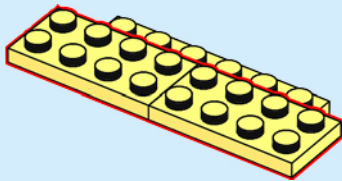

187

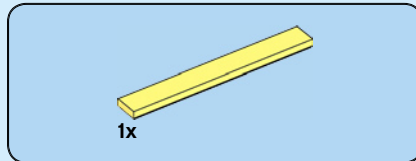
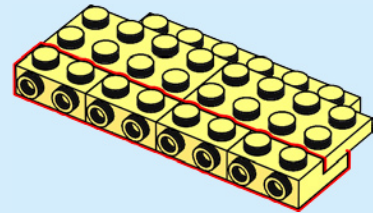

188

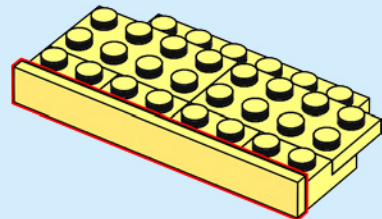

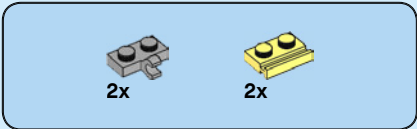

189

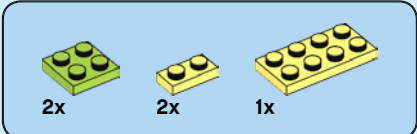
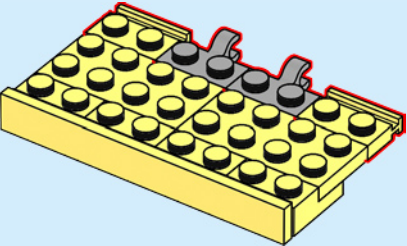

190

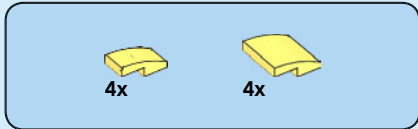
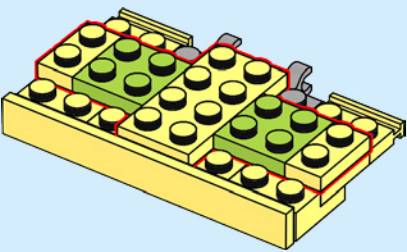

191

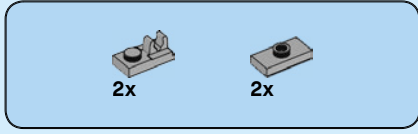
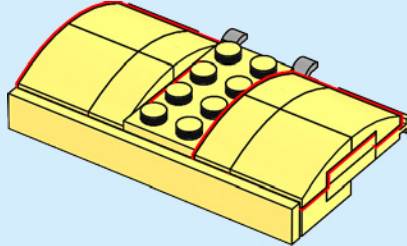

192

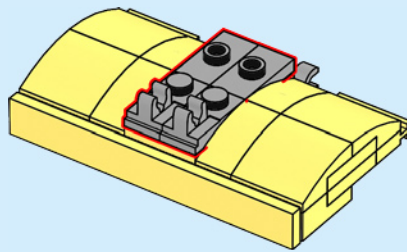

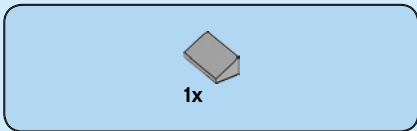

193

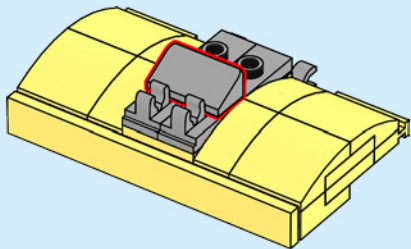

194

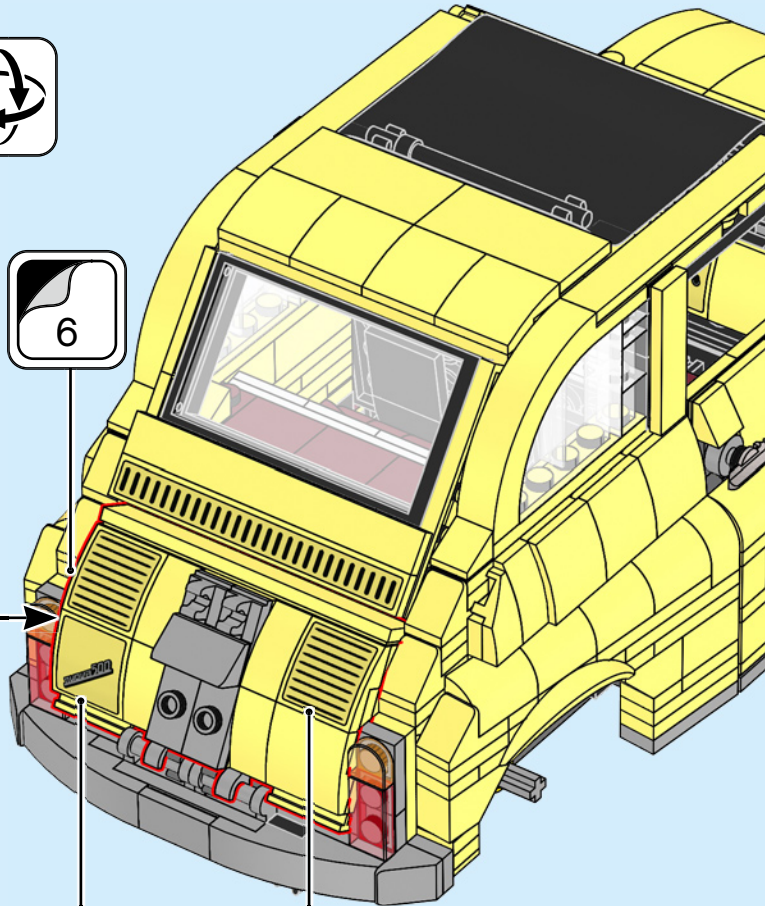

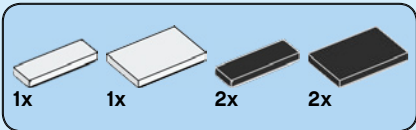

195

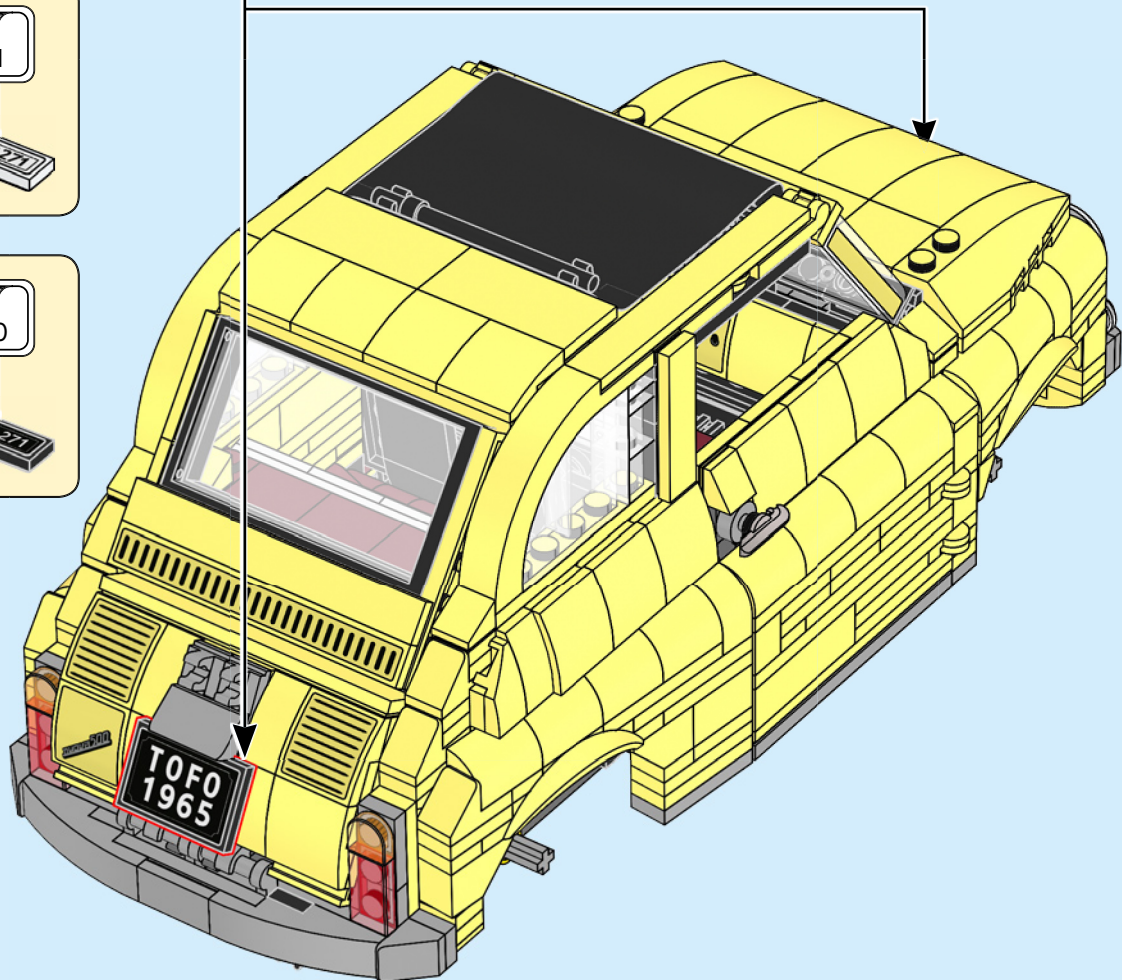
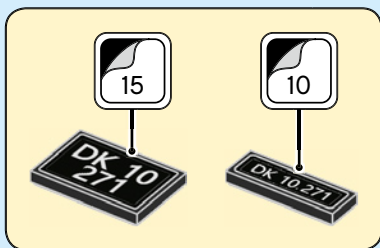
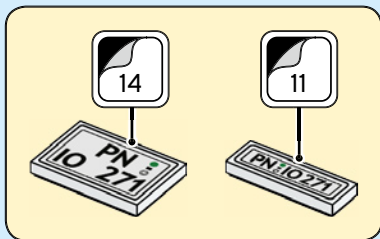
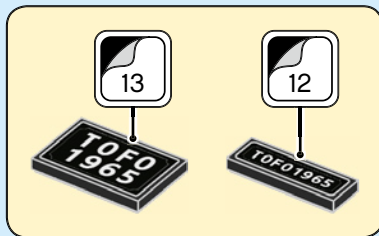

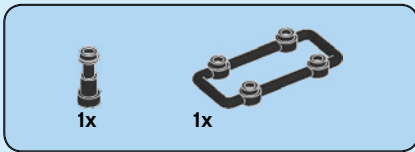

196

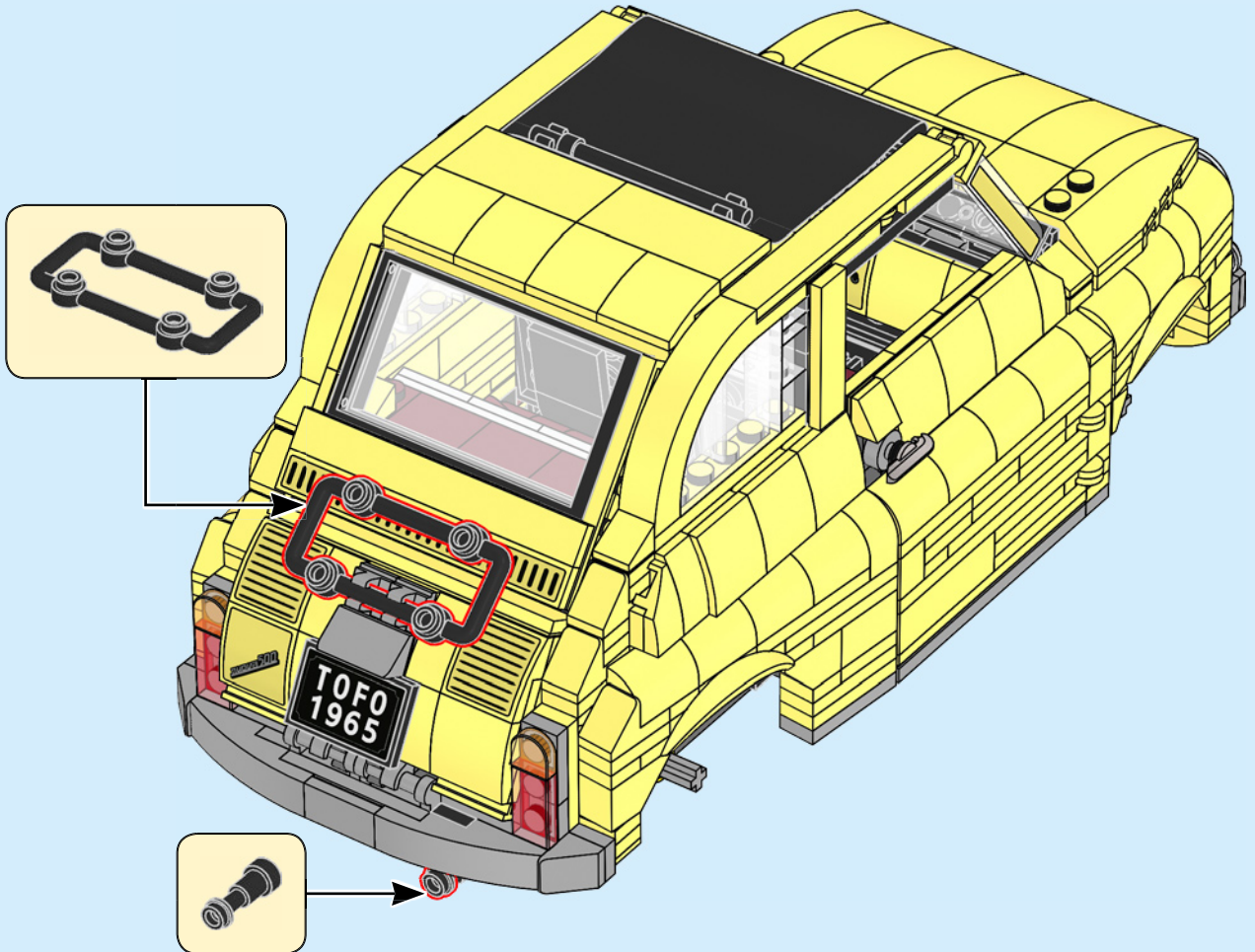



1x

197



1x



1x

198

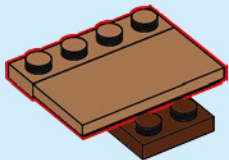

4x

199

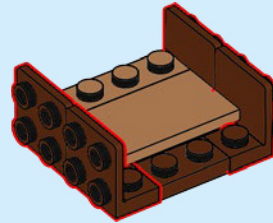

2x



1x



1x

200

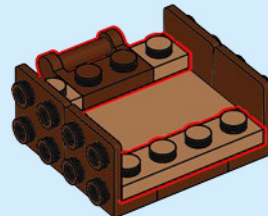

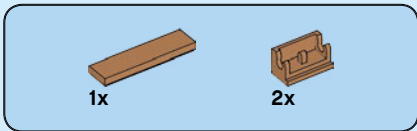

201

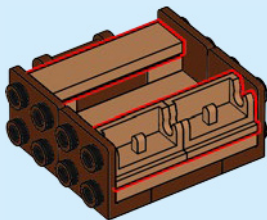

202

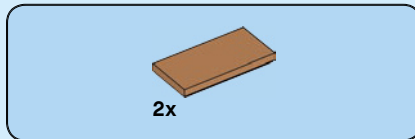
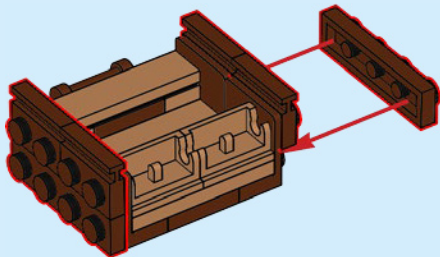

203

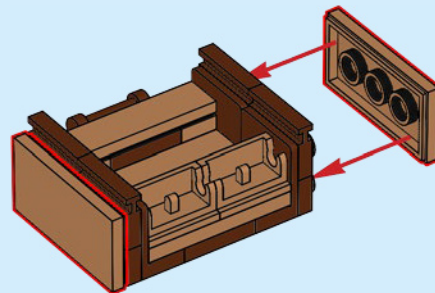

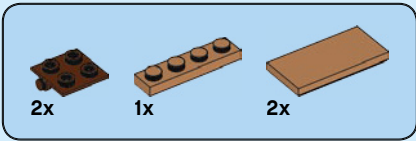

204

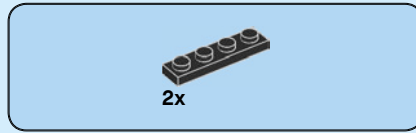
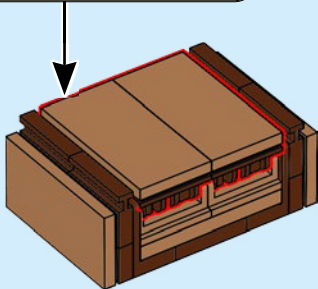
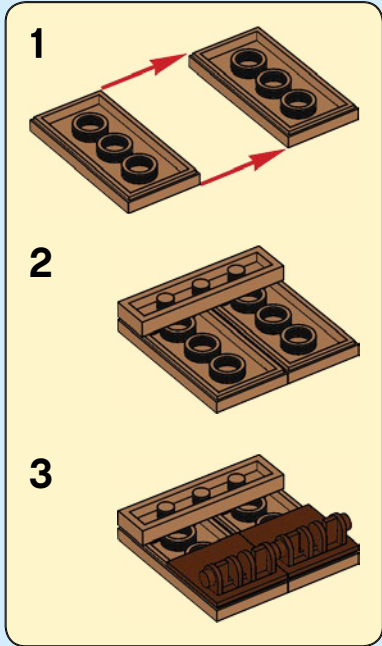

205

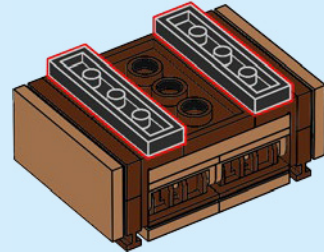

206

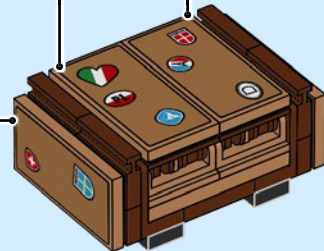
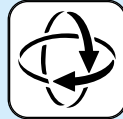

207

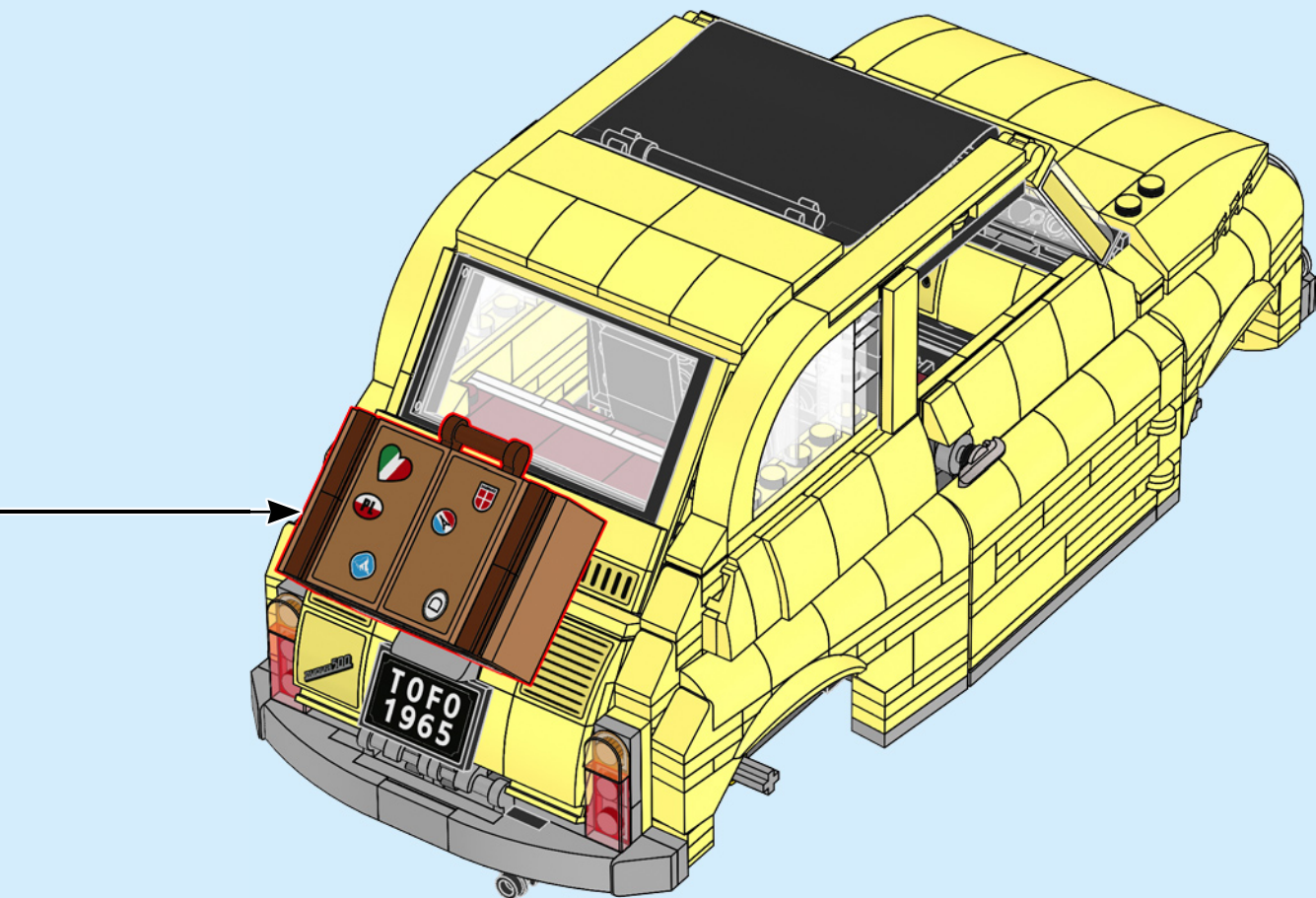

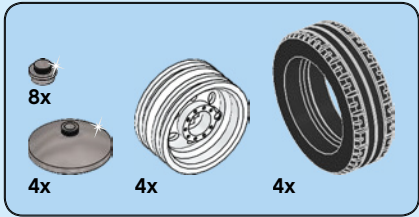

208

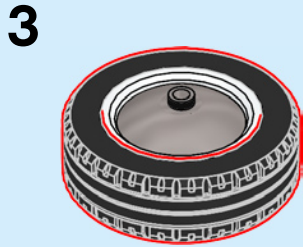
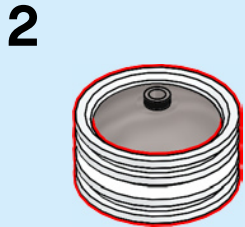
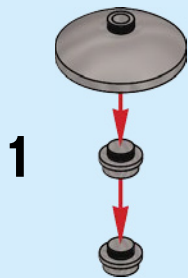

4x

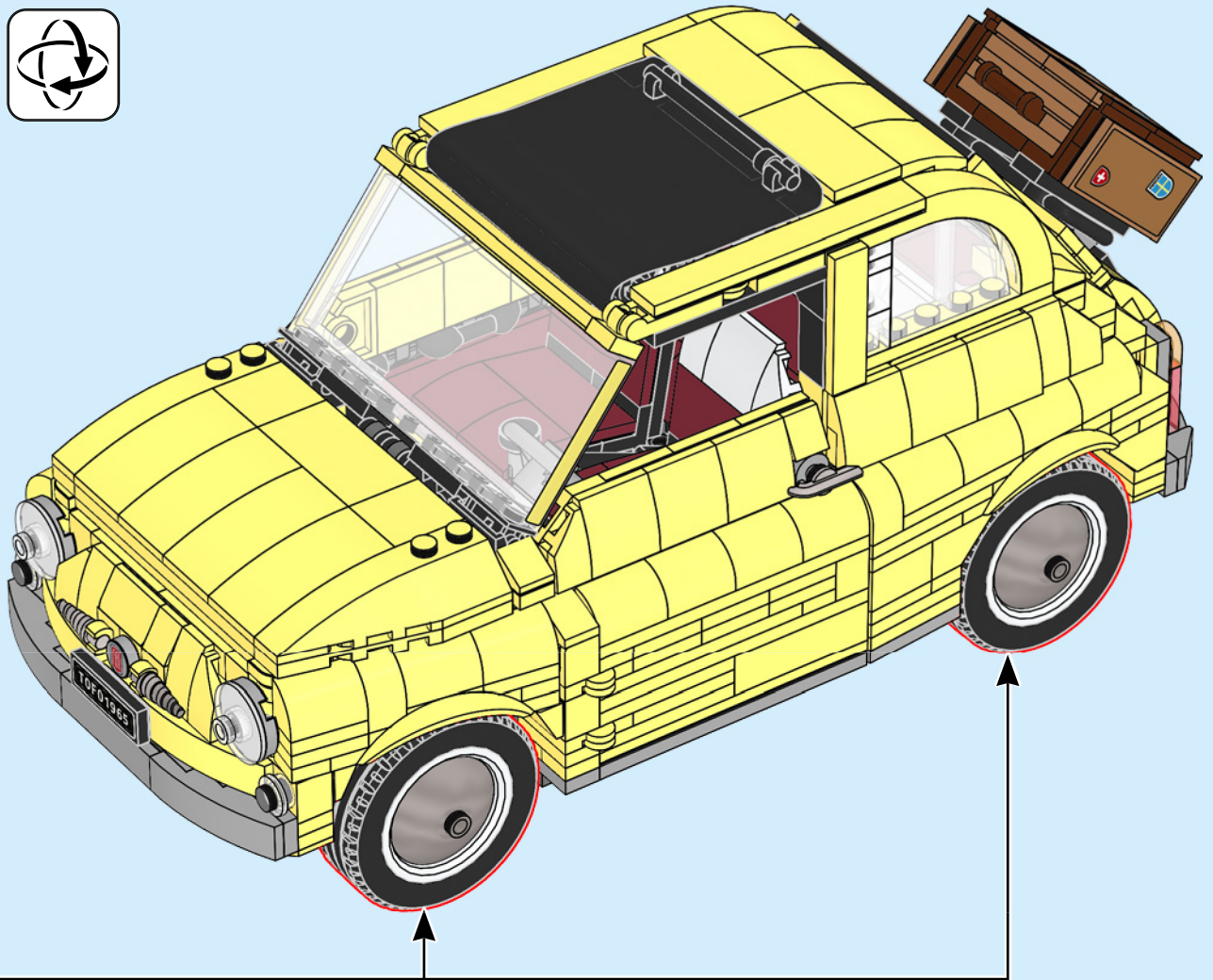

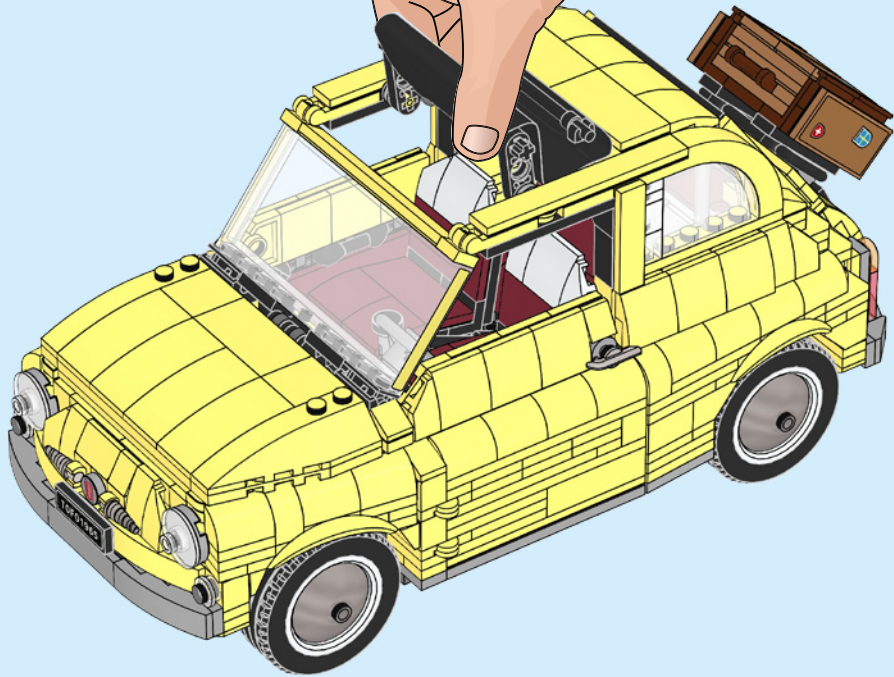

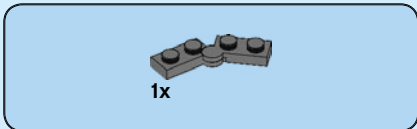

209

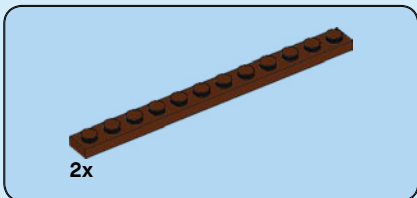
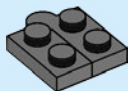

210

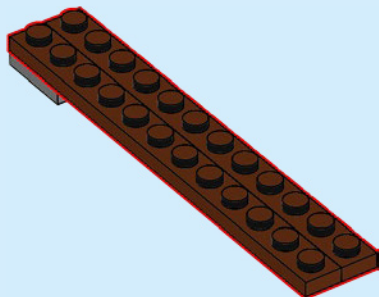

211

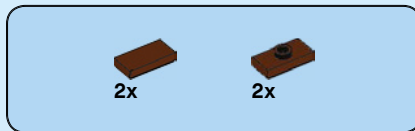
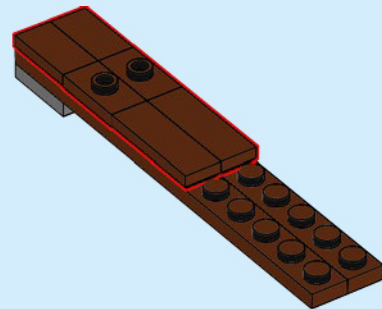

212

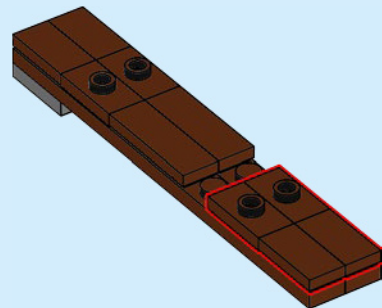

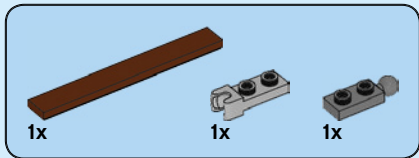

213

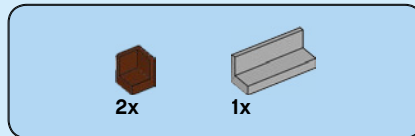
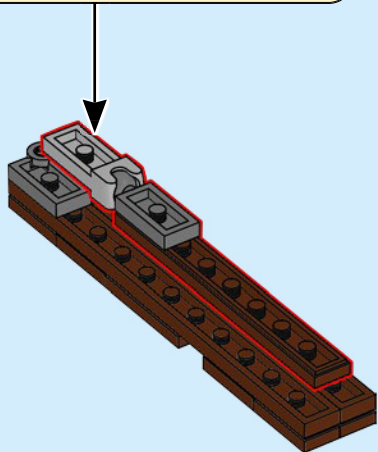
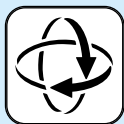
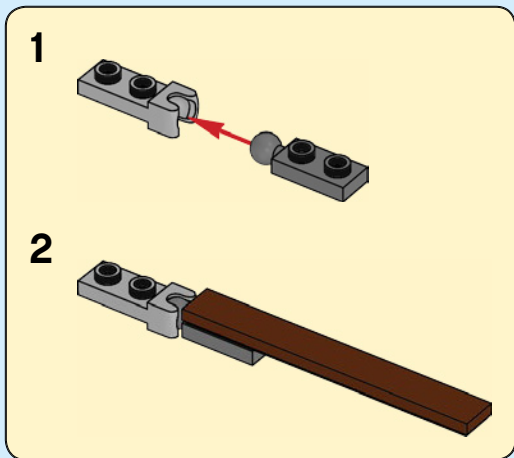

214

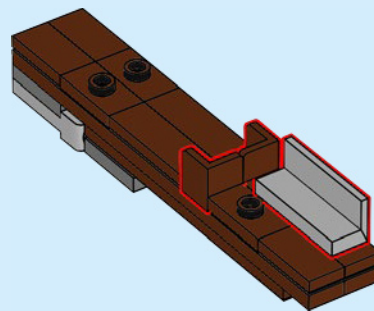

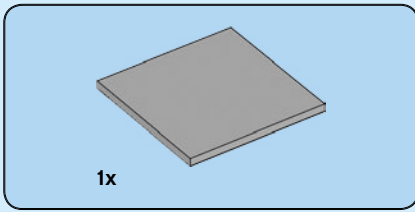

215

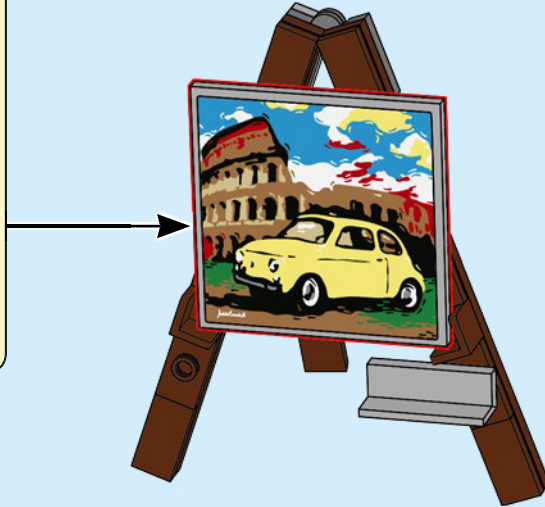
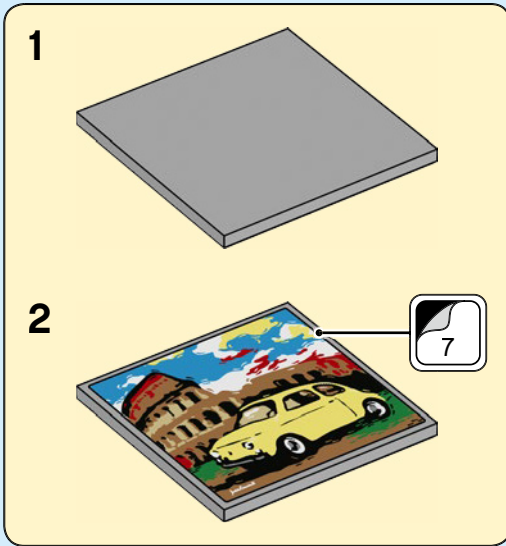

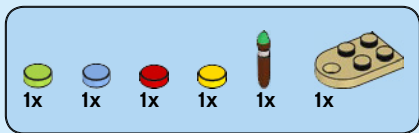

216

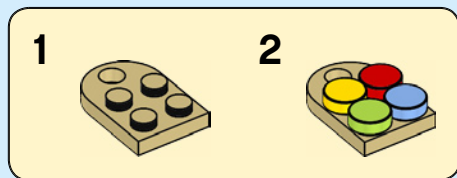

217

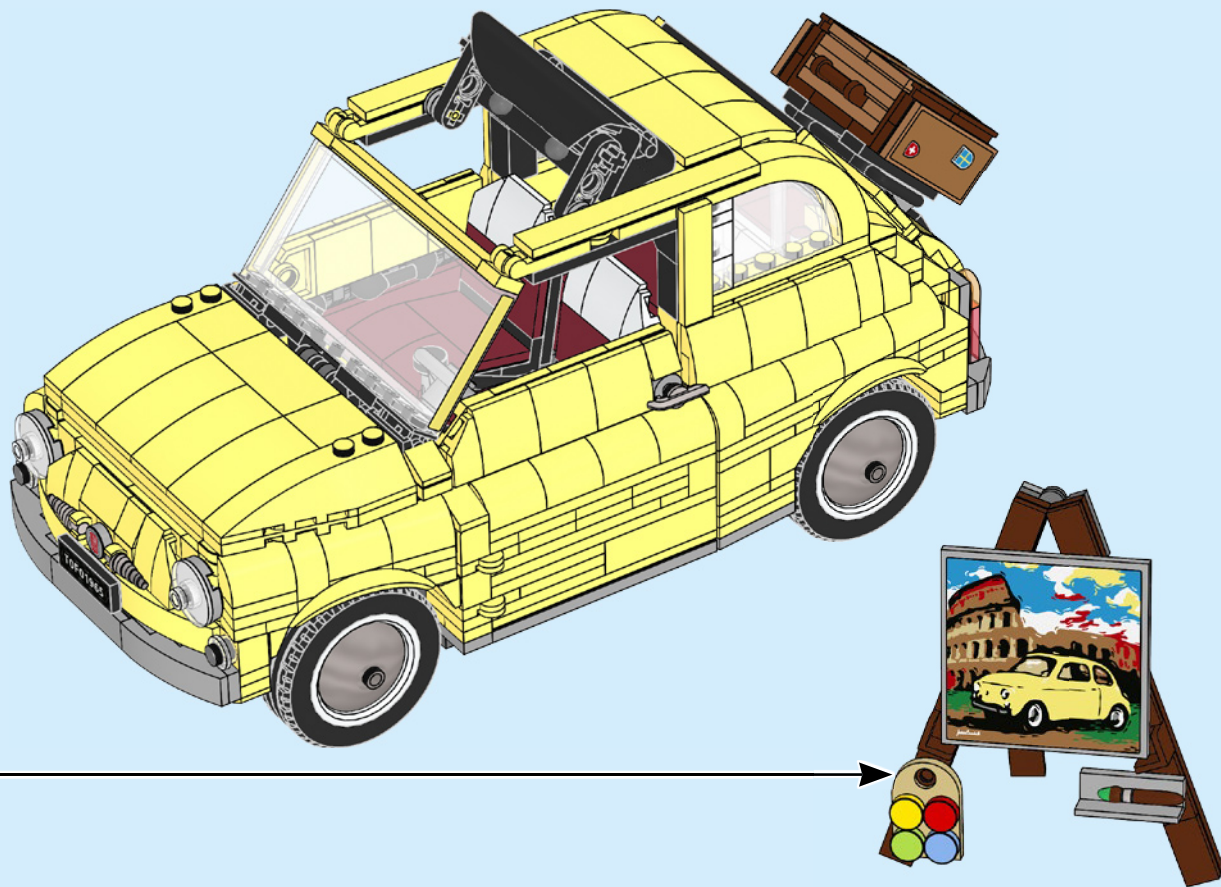

LEGO® Creator Expert – do you like it?



The LEGO Group would like your opinion on the new product you have just purchased.
Your feedback will help shape the future development of this product series.

Please visit:

[LEGO.com/productfeedback](https://www.lego.com/productfeedback)

By completing our short feedback survey, you will be automatically entered into a drawing to win a LEGO® prize.

Terms & Conditions apply.

2x
6284572

2x
6213880

1x
6210272

2x
6213881

6x
6047220

1x
4558168

1x
6156667

5x
4539270

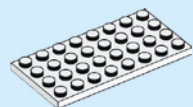

1x
303501

1x
6284574

1x
6215539

4x
6271820

1x
6092565

2x
6251290

1x
6170421

4x
73587

1x
4538456

2x
6143318

3x
6284070

1x
362626

3x
4504382

3x
307026

2x
6228987

1x
4184169

1x
6281993

1x
242026

5x
4515368

2x
6271869

2x
4558170

1x
4180508

2x
6173119

3x
4109810

8x
4121715

1x
6122656

7x
4598528

2x
6069000

8x
6092585

2x
6138173

5x
241226

4x
300426

2x
393826

4x
4121966

26x
362326

2x
6092570

4x
366526

7x
302326

2x
393726

3x
6000650

4x
6250020

1x
4107761

2x
6151289

2x
4107828

1x
6093525

1x
302226

2x
6211476

10x
6061032

2x
6013867

1x
4565323

2x
243126

3x
6196548

2x
6162892

4x
302126

1x
6288582

2x
4515362

1x
4535834

1x
6280168

5x
6182551

3x
302026

1x
4560182

1x
6172984

3x
6192346

2x
4243819

2x
6168620

3x
663626

2x
300926

4x
366626

3x
346026

1x
6037390

1x
611126

2x
303526

1x
383226

1x
6296972

3x
4550017

2x
371026

2x
6240030

4x
6220959

2x
6252041

2x
6245306

2x
6240204

1x
6256058

2x
6288587

1x
6288588

1x
6289133

1x
6240515

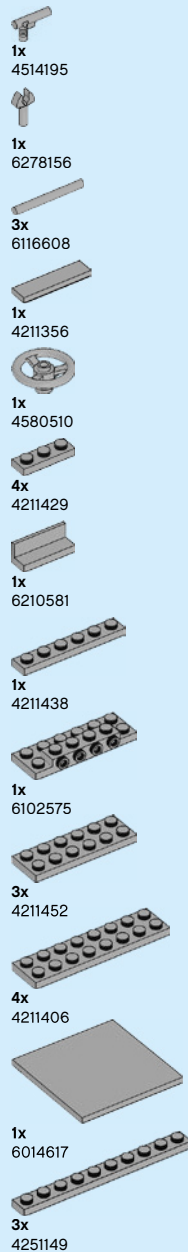

5

2x 4211090
 3x 4210633
 3x 6071226
 2x 6225494
 2x 6158469
 6x 4210892
 2x 4211111
 3x 4581225
 1x 6123814
 2x 6247784
 6x 4210884
 6x 4211043
 1x 4211106

6x 4210963

2x 6249116
 1x 6124611
 1x 6284577
 8x 6271167
 4x 6250598
 35x 6058014
 9x 6296498
 3x 6296500
 7x 6022084
 2x 6296526
 4x 6296531
 4x 6228969
 18x 6296501
 2x 6296963
 3x 6296509
 1x 6296528

1x 6296533
 5x 6296510
 2x 6296512
 2x 6296513
 12x 6147726
 4x 6061201
 4x 6070301
 2x 6298528
 22x 6296494
 6x 6296495
 7x 6296507
 2x 6022083
 2x 6117317

4x 6133822
 35x 6201647
 6x 6296497
 6x 6296485
 6x 6296496
 2x 6296519
 6x 6298527
 20x 6296487
 6x 6296511
 2x 6286832
 4x 6296521
 2x 6296964
 4x 6201646
 13x 6296492

2x 6195265
 2x 6036232
 2x 6296493
 17x 6248756
 3x 6289722
 2x 6296536
 8x 6296491
 4x 6296523
 5x 6296524
 3x 6210674
 2x 6289285

4x 6296535
 12x 6211356
 4x 6296488
 1x 6296527
 4x 6175294
 1x 6296525
 9x 6296504
 10x 6248761
 3x 6213270

1x 6209691
 2x 6215606
 2x 6167642
 4x 6259768
 1x 6167698
 1x 6102998
 3x 6167700
 5x 6218359
 1x 6170776
 2x 4569058
 1x 6057878
 4x 4537937

Customer Service
Kundenservice
Service Consommateurs
Servicio Al Consumidor
LEGO.com/service or dial

: 00800 5346 5555
: 1-800-422-5346

